

Scanned by TuXaMaT.
My Home Page
<http://www.tuxamat.h12.ru>

HYUNDAI

Owner's Manual

Accent



HYUNDAI

Accent

H-1A0PC

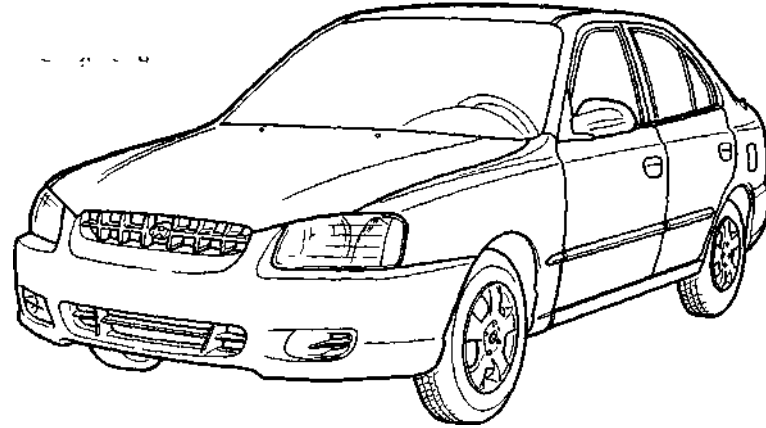

YA020A1 F

OWNER'S MANUAL

Operation
Maintenance
Specifications

Note

information in this Owner's Manual is current at the time of publication. However, Hyundai reserves the right to make changes at any time so that our policy of continual product improvement may be carried out.

This manual applies to all current Hyundai models and includes descriptions and explanations of optional as well as standard equipment. As a result, you may find material in this manual that does not apply to your specific vehicle.

FOREWORD

Thank you for choosing Hyundai. We are pleased to welcome you to the growing number of discriminating people who drive Hyundais. The advanced engineering and high-quality construction of each Hyundai we build is something of which we're very proud.

Your Owner's Manual will introduce you to the features and operation of your new Hyundai. It is suggested that you read it carefully since the information it contains can contribute greatly to the satisfaction you receive from your new car.

The manufacturer also recommends that all service and maintenance on your car be performed by an authorized Hyundai dealer. Hyundai dealers are prepared to provide high-quality service, maintenance and any other assistance that may be required.

HYUNDAI MOTOR COMPANY

Note: Because future owners will also need the information included in this manual, if you sell this Hyundai, please leave the manual in the vehicle for their use. Thank you.

Copyright 2000 Hyundai Motor Company. All rights reserved. The material in this publication may not be reproduced in any form without written permission from Hyundai Motor Company.

RESPONSIBILITY FOR MAINTENANCE

The maintenance requirements for your new Hyundai are found in Section 5. As the owner, it is your responsibility to see that all maintenance operations specified by the manufacturer are carried out at the appropriate intervals. When the vehicle is used in severe driving conditions, more frequent maintenance is required for some operations. Maintenance requirements for severe operating conditions are also included in Section 5.

CAUTION: MODIFICATIONS YOUR HYUNDAI

Modification of components may void the manufacturer's warranty

Your Hyundai should not be modified in any way. Modifications may adversely affect the safety, durability and performance of your Hyundai. Components which are subjected to modification or are added to the vehicle resulting in consequential damage are not covered by the vehicle manufacturer's warranty.

TWO-WAY RADIO INSTALLATION CAUTION

Your vehicle is equipped with electronic fuel injection and cruise control. It is possible for an improperly installed/adjusted two-way radio to adversely affect electronic systems. For this reason, we recommend that you carefully follow the radio manufacturers' instructions or consult your Hyundai dealer for precautionary measures or special instructions.

A100A01LGAT

GUIDE TO HYUNDAI GENUINE PARTS

1. What are Hyundai Genuine Parts?

Hyundai Genuine Parts are the same parts used by Hyundai Motor Company to manufacture vehicles. They are designed and tested for the optimum safety, performance, and reliability to our customers.

2. Why should you use genuine parts?

Hyundai Genuine Parts are engineered and built to meet rigid original manufacturing requirements. Using imitation, counterfeit or used salvage parts are not covered under the Hyundai

New Vehicle Limited Warranty or any other Hyundai warranty. In addition, any damage to or failure of Genuine Hyundai Parts caused by the installation or failure of an imitation, counterfeit or used salvage part is not covered by Hyundai Motor Company.

3. How can you tell if you purchasing Hyundai Genuine Parts?

Look for the Hyundai Genuine Parts Logo on the package (see below).

The export specifications are written in English only.

Hyundai Genuine Parts are only sold through authorized Hyundai Dealership and Service Center.

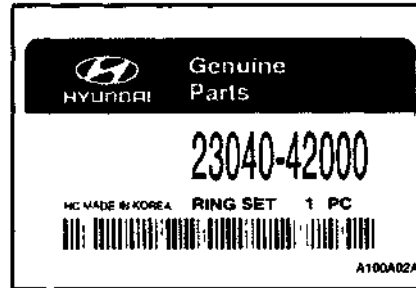
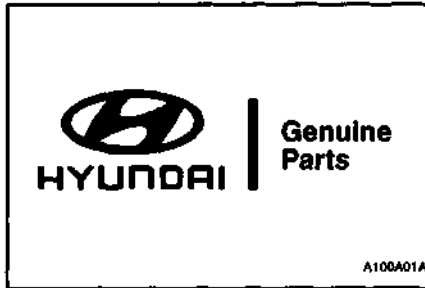
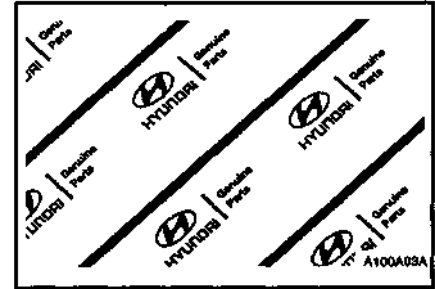

TABLE OF CONTENTS

SECTION	PAGE
1. A GUIDED TOUR — Features of Your Hyundai.....	1-1
2. BEHIND THE WHEEL — Driving Your Hyundai.....	2-1
3. TROUBLE ON THE ROAD — What to do in an Emergency.....	3-1
4. KEEPING THOSE GOOD LOOKS — Corrosion Prevention & Appearance Care.....	4-1
5. THE KEY TROUBLE-FREE OPERATION — Vehicle Maintenance Requirements.....	5-1
6. SATURDAY MECHANICS — Do-It-Yourself Maintenance.....	6-1
7. EMISSION CONTROL SYSTEM.....	7-1
8. THINGS YOU SHOULD KNOW — Consumer Information.....	8-1
9. VEHICLE SPECIFICATIONS.....	9-1
10. INDEX.....	10-1

SAFETY AND VEHICLE DAMAGE WARNING

This manual includes information titled as WARNING, CAUTION and NOTE.
These titles indicate the following:

WARNING:

This indicates that a condition may result in harm or injury to you or other persons if the warning is not heeded. Follow the advice provided with the warning.

CAUTION:

This indicates that a condition may result in damage to your vehicle or its equipment if the caution is not heeded. Follow the advice provided with the caution.

NOTE:

This indicates that interesting or helpful information is being provided.

FEATURES OF YOUR HYUNDAI

1. A GUIDED TOUR

Features of Your Hyundai

B010A01A-GAT

FUEL RECOMMENDATIONS

Use Unleaded Gasoline

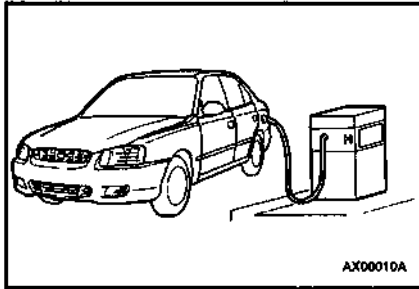

Unleaded gasoline with a Pump Octane Rating of 87 (Research Octane Number 91) or higher must be used in Hyundai vehicle. If leaded gasoline is used, it will cause the catalytic converter to become ineffective and the emission control system to malfunction.

This can also result in increased maintenance expense. To avoid accidental use of leaded fuel, the large nozzle used with leaded gasoline at service stations can not be inserted into fuel tank opening of Hyundai vehicle.

NOTE:

For some countries, Hyundai vehicles are designed to use leaded gasoline. When you are going to use leaded gasoline, ask to Hyundai dealer whether leaded gasoline in your vehicle is available or not.

B010B01A-AAT

What About Gasohol?

Gasohol (a mixture of 90% unleaded gasoline and 10% ethanol or grain alcohol) may be used in your Hyundai. However, if your engine develops driveability problems, the use of 100% unleaded gasoline is recommended. Fuels with unspecified quantities of alcohol, or alcohols other than ethanol, should not be used.

B010001S-AAT

Do not Use Methanol

Fuels containing methanol (wood alcohol) should not be used in your Hyundai. This type of fuel can reduce vehicle performance and damage components of the fuel system.

CAUTION:

Your Hyundai's New Vehicle Limited Warranty may not cover damage to the fuel system and performance problems that are caused by the use of methanol or fuels containing methanol.

B010E01A-AAT

Gasolines for Cleaner Air

To help contribute to cleaner air, Hyundai recommends that you use gasolines treated with detergent additives, which help prevent deposit formation in the engine. These gasolines will help the engine run cleaner and the Emission Control System performance.

B010F01A-AAT

Operation in Foreign Countries

If you are going to drive your Hyundai in another country, be sure to:

- o Observe all regulations regarding registration and insurance.
- o Determine that acceptable fuel is available.

ZB020A1-Q

BREAKING IN YOUR NEW HYUNDAI

During the First 2,000 km (1,200 miles)

No formal "break-in" procedure is required with your new Hyundai. However, you can contribute to the economical operation and durability of your Hyundai by observing the following recommendations during the first 2,000 km (1,200 miles).

- o Don't drive faster than 88 km/h (55 mph).
- o While driving, keep your engine speed (rpm, or revolutions per minute) between 2000 and 4000 rpm.

FEATURES OF YOUR HYUNDAI

- o Use moderate acceleration. Don't start, depress the, accelerator pedal fully.
- o For the first 300 km (200 miles), try to avoid hard stops.
- o Don't lug the engine (in other words, don't drive so slowly in too-high a gear that the engine "bucks": shift to a lower gear).
- o Whether going fast or slow, vary your speed from time to time.
- o Don't let the engine idle longer than 3 minutes for a catalytic converter-equipped engine.
- o Don't tow a trailer during the first 2,000 km (1,200 miles) of operation.

B030A01A-AAT

KEYS

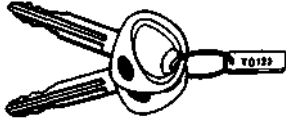

For greater convenience, the same key operates all the locks in your Hyundai. However, because the doors can be locked without a key,

1-2

carrying a spare key is recommended in case you accidentally lock one key inside the car.

Record Your Key Number

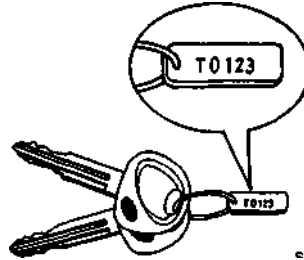

A code number is stamped on the number plate that came with the keys to your Hyundai. This key number plate should not be left with the keys but kept in a safe place, not in the vehicle. The key number should also be recorded in a place where it can be found in an emergency. If you need additional keys, or if you should lose your keys, your authorized Hyundai dealer can make new keys if you can supply the key number.

BBHOA01A-GAT

IMMOBILIZER SYSTEM (if Installed)

The immobilizer system is an anti-theft device, designed to deter automobile theft.

B880B03A-GAT

Keys

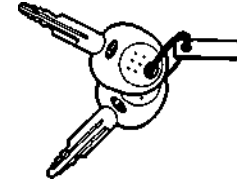

All of the locks fitted to the vehicle are operated by the same key. However, since it is possible to lock the doors without the use of the key, care should be exercised to ensure that the key does not become locked inside the vehicle by mistake.

NOTE:

If you make your own duplicate key, you will not be able to cancel the system or start the engine.

FEATURES OF YOUR HYUNDAI

B880C02A-GAT

Key Numbers

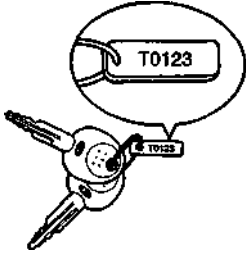

The vehicle key number is recorded upon a metal tag attached to the keys when the vehicle is first delivered to you.

The key number should be recorded and kept in a safe place in case the need to order further keys arises. New keys are available from any Hyundai dealer by quoting the relevant key number.

In the interest of security, the metal tag attached to the keys which bears the key number should be removed from the key ring after you receive your new vehicle. In addition, key numbers cannot be provided by Hyundai for security reasons.

If you need additional keys or if you should lose your keys, your authorized Hyundai dealer can make new keys.

B880D02A-QAT

Limp home procedures

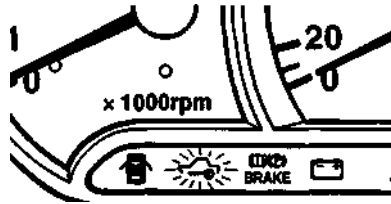

In case the immobilizer warning indicator blinks for five seconds when the ignition key is turned to "ON" position, this indicates that the immobilizer system is out of order. And you cannot start the engine without the limp home procedures with ignition key.

The following procedure is how to start the engine with the function of the limp home. (0,1, 2, 3 as a sample password).

NOTE:

You can get the limp home password when the vehicle is first delivered to you. If you do not have the password, consult your authorized Hyundai dealer.

1. To set the password you may turn the ignition key "ON" and then turn it "OFF" according to the digit numbers, then the immobilizer indicator will blink along with the operation of the ignition key. For example, turn the

ignition key once for digit number "1", and twice for "2", and so on. However, for the digit number "0", you must turn the ignition key for 10 times.

2. Wait for 3~10 seconds.
3. You may set the remaining number of digits by following the same procedures 1 and 2.
4. If all of four digits have been tried successfully, turn the ignition key "ON" and check that the immobilizer indicator illuminates. From this time, you have to start your engine within 30 seconds. If you start your engine after 30 seconds, your engine will not start.

NOTE:

If the engine dies while driving after limp home procedure, you can start your engine within 8 seconds without limp home procedure again.

5. If the immobilizer indicator blinks for five seconds, you have to try the limp home procedure again from the beginning.

After doing the limp home procedure, you have to consult with your authorized Hyundai dealer as soon as possible.

CAUTION:

- If you fail to try the limp home procedure with the sequence of three times, you have to wait for about one hour to do the limp home procedure again.
- If you can not start your engine in spite of limp home procedure, have your vehicle towed by an authorized Hyundai dealer.

FEATURES OF YOUR HYUNDAI

B070A01A-GAT

THEFT-ALARM SYSTEM

This system is designed to provide protection from unauthorized entry into the car. This system is operated in three stages: the first is the "Armed" stage, the second is the "Alarm" stage, and the third is the "Disarmed" stage. If triggered, the system provides an audible alarm siren with blinking of the turn signal lamp.

B070B01A-GAT

Armed Stage

Park the car and stop the engine. Arm the system as described below.

- 1) Remove the ignition key from the ignition switch.
- 2) Make sure that the engine hood and trunk lid are locked.
- 3) Lock the doors using the transmitter of the keyless entry system.

After completion of the steps above, the turn signal lamp will blink once to indicate that the system is armed.

NOTE:

- 1) If any door, trunk lid or engine hood remains open, the system will not be armed.
- 2) If this happens, rearm the system as described above.

CAUTION:

Do not arm the system until all passengers

have left the car. If the system is armed while a passenger(s) remains in the car, the alarm may be activated when the remaining passenger(s) leaves the car.

B070C03A-GAT

Alarm Stage

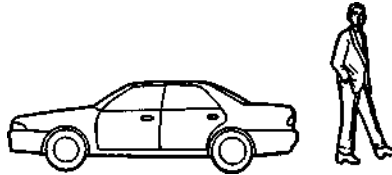

The alarm will be activated if any of the following occurs while the car is parked and the system is armed.

- 1) A front or rear door is opened without using the transmitter or the ignition key.
- 2) The trunk lid is opened without using the ignition key.
- 3) The engine hood is opened.

The siren will sound and the turn signal lamp will blink continuously for 30 seconds. (E.C only/Except E.C : 3 times). To turn off the system, unlock the door with the transmitter or the ignition key.

CAUTION:

Avoid trying to start the engine while the system is armed.

B070D01A-GAT

Disarmed Stage

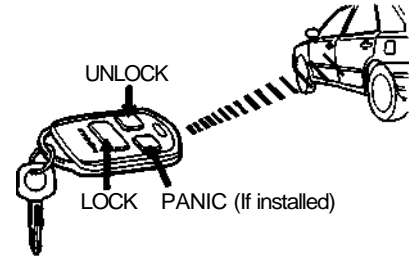

The system will be disarmed when the following step is taken:

The driver's or passenger's door is unlocked by depressing the "UNLOCK" button on the transmitter or the ignition key.

After completion of the steps above, the turn signal lamp will blink twice to indicate that the system is disarmed.

NOTE:

Once the system has been disarmed, it can not be rearmed except by repeating the arming procedures.

FEATURES OF YOUR HYUNDAI

B070E02A-GAT

Panic Stage (If installed)

1. Push the "PANIC" button on the transmitter.
2. At the same time, the siren will sound continuously.
3. To turn off the system, push the "PANIC" button again on the transmitter.

B070F01A-QAT

Keyless Entry System

Locking doors

1. Close all doors.
2. Push the "LOCK" button on the transmitter.
3. At the same time all doors lock, the turn signal lamp will blink once to indicate that the system is armed.

Unlocking doors

1. Push the "UNLOCK" button on the transmitter.
2. At the same time all doors unlock, the turn signal lamp will blink twice to indicate that the system is disarmed.

B040A01A-AAT

DOOR LOCKS

WARNING:

- o **Unlocked doors can be dangerous. Before you drive away (especially if there are children in the car), be sure that all the doors are securely closed and locked so that the doors cannot be inadvertently opened from the Inside. This helps as-**

sure that doors will not be opened accidentally.

Also, when combined with the proper use of seat belts, locking the doors helps keep occupants from being ejected from the car in case of an accident.

- o Before opening the door, always look for and avoid oncoming traffic.

B040B01A-AAT

Locking and Unlocking Front Doors With a Key

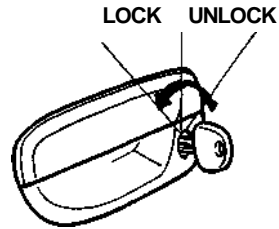

- o The door can be locked or unlocked with a key.
- o Lock the door by turning the key toward the front of the vehicle and unlock it by turning the key toward the rear.

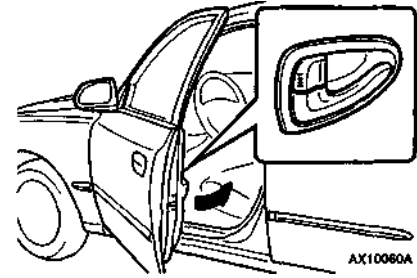

The doors can be locked without a key.

To lock the doors from the outside, first push the inside lock switch to the "LOCK" position, then close the door.

NOTE:

- o When locking the door this way, be careful not to lock the door with the ignition key left in the vehicle.
- o To protect against thieves, always remove the ignition key, close all windows, and lock all doors when leaving your vehicle unattended.

FEATURES OF YOUR HYUNDAI

8040001A AAT

Locking from the Inside

LOCK

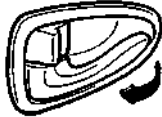

UNLOCK

To lock the doors from the inside, simply close the door and push the lock switch to the "LOCK" position. When this is done, neither the outside nor the inside door handle can be used.

BMOE02A-AAT

CHILD-PROTECTOR REAR DOOR LOCK



Your Hyundai is equipped with a "child-protector" rear door lock assembly. When the lock mechanism is engaged, the rear door cannot be opened from the inside. Its use is recommended whenever there are small children in the rear seat.

To engage the child-protector feature so that the door cannot be opened from the inside, move the child-protector lever to the "LOCK" position and close the door. Move the lever to the opposite direction of "LOCK" position when normal door operation is desired.

If you wish to be able to open the door from the outside, the outside door handle will function normally.

B140A01S-AAT

REAR SEAT WARNING



For the safety of all passengers, luggage or other cargo should not be piled higher than the top of the seatback. In addition, do not place objects on the rear shelf as they may move

forward during braking or in an accident and strike vehicle passengers.

B080A01A AAT

ADJUSTABLE FRONT SEATS

WARNING:

Never attempt to adjust the seat while the vehicle is moving. This could result in loss of control, and an accident causing death, serious injury, or property damage.

B080601A-AAT

Adjusting Seat Forward and Rearward

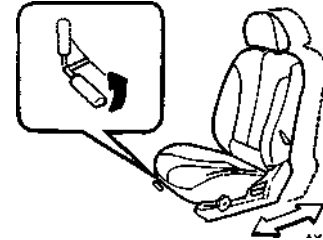

To move the seat toward the front or rear, pull the lock release lever upward. This will release the seat on its track so you can move it forward or rearward to the desired position.

When you find the position you want, release the lever and slide the seat forward or rearward

FEATURES OF YOUR HYUNDAI

on its track until it locks into the desired position and cannot be moved further.

B080C01A-AAT

Adjusting Seatback Angle

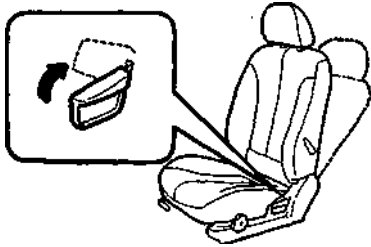

To recline the seatback, lean forward to take your weight off it, then pull up on the recliner control lever at the outside edge of the seat. Now lean back until the desired seatback angle is achieved. To lock the seatback into position, release the recliner control lever.

WARNING:

To minimize risk of severe injury in the event of a collision or sudden stop, both the driver and passenger seatbacks should always be in a nearly upright position while the vehicle is in motion. The protection provided by the seat belts and airbags may be reduced significantly when the seatback is

reclined. There is greater risk that the driver and passenger will slide under the belt which may result in serious injury if a crash occurs when the seatback is reclined.

B080O02A-AAT

Adjustable Headrests

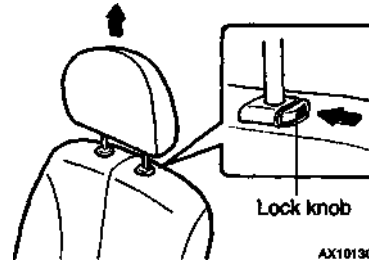

Headrests are designed to help reduce the risk of neck injuries.

To raise the headrest, pull it up. To lower it, push it down while pressing the lock knob.

WARNING:

o For maximum effectiveness in case of an accident, the headrest should be adjusted so the top of the headrest is at the same height as the top of the occupant's ears. The use of a cushion that holds the body away from the seatback is not recommended.

o Do not operate the vehicle with the headrests removed as severe injury to an occupant may occur in the event of an accident. Headrests may provide protection against severe neck injuries when properly adjusted.

B080E01A-MT

Lumbar Support Control (Driver's seat only) (if installed)

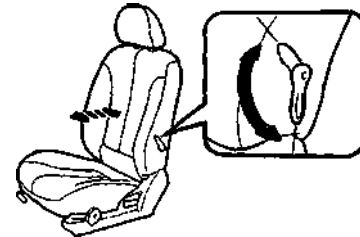

To adjust the lumbar support, turn the handle on the inboard side of the seat. To increase the amount of lumbar support, pull the lever forward. To decrease it, push the lever toward the rear.

FEATURES OF YOUR HYUNDAI

B080F01S-AAT

Seat Cushion Height Adjustment (Driver's Seat Only) (If Installed)

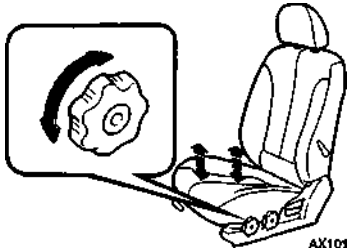

To raise or lower the front part of the seat cushion, turn the front knob forward or rearward. To raise or lower the rear part of the seat cushion, turn the rear knob forward or rearward.

B100A01A-GAT

SEAT WARMER (If Installed)

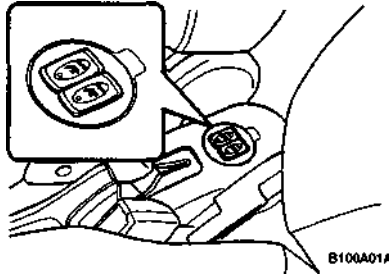

The seat warmer is provided to warm the front seats during cold weather. With the ignition key in the "ON" position, push either of the switches on the rear console to warm the driver's seat or the passenger's seat.

During mild weather or under conditions where the operation of the seat warmer is not needed, keep the switches in the "OFF" position.

B130A01A-AAT

REAR SEAT ENTRY (For 3-door model)

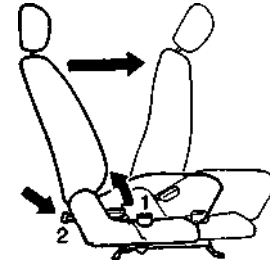

The front passenger seatback should be tilted to enter the rear seat.

By pulling up on the recliner control lever (1) at the outside of the front passenger seat, the seatback will tilt forward and the seat will automatically slide forward.

Rear seat occupants can tilt the front passenger seatback by depressing the foot lever (2) as shown in the illustration.

WARNING:

Passengers sitting in the rear seat should be careful not to accidentally press the foot lever (2) while the vehicle is moving, as this may cause the seatback to move forward and injure a front seat occupant.

FEATURES OF YOUR HYUNDAI

B050A01A-AAT

WINDOW GLASS

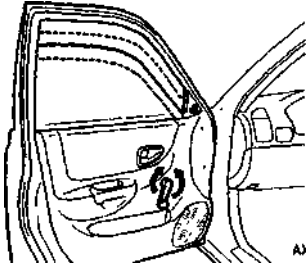

To raise or lower the window, turn the window regulator handle clockwise or counter-clockwise.

WARNING:

When opening or closing the windows, make sure your passenger's arms, hands and body are safely out of the way.

B060A03A-GAT

POWER WINDOWS (If installed)

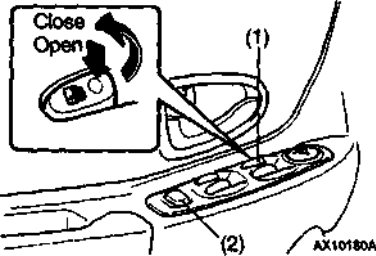

The power windows operate when the ignition key is in the "ON" position. The main switches are located on the driver's armrest and control the front and rear windows on both sides of the vehicle. The windows may be opened by depressing the appropriate window switch and closed by pulling up the switch. To open the window on the driver's side, press the switch(1) down. The window moves as long as the switch is operated. In order to prevent operation of the windows, a window lock switch(2) is provided on the armrest of the driver's door. To disable the power windows, press the window lock switch.

To revert to normal operation, press the window lock switch a second time.

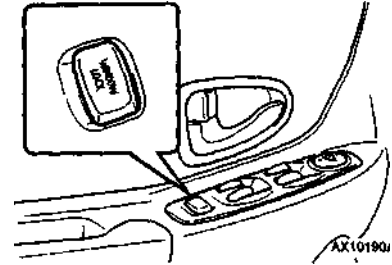

WARNING:

- 1) Be careful that someone's head, hands and body are not trapped by a closing window.
- 2) Never try to operate the main switch on the driver's door and the individual door window switch in opposing directions at the same time. If this is done, the window will stop and cannot be opened or closed.
- 3) Do not leave children alone in the car. Always remove the ignition key for their safety.

FEATURES OF YOUR HYUNDAI

B040G02A-GAT

CENTRAL DOOR LOCKING SYSTEM (If Installed)

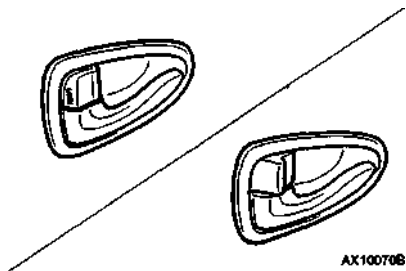

This system is controlled by the driver's door lock and operates the passenger door locks. When the driver's door is locked, the passenger doors are locked automatically.

If a rear door is open when the door lock switch is depressed, it will remain locked when closed. If the front passenger door is open when the door lock switch is locked, the outside door handle must be held in the raised position. When the door is closed, the door will remain locked. All doors will be unlocked automatically whenever the driver's door is unlocked whether by key or door lock switch.

B150A02A-QAT

SEAT BELT PRECAUTIONS

All occupants of the vehicle should wear their seat belts at all times. Indeed, your province's laws may require that some or all occupants of the vehicle use seat belts.

The possibility of injury or the severity of injury in an accident will be decreased if this elementary safety precaution is observed. In addition, the following recommendations are made:

B150B01A GAT

Infant or Small Child

Some countries require the use of child restraint systems for infants and small children. Whether this is required by law or not, it is strongly recommended that a child restraint seat or infant restraint system be used for infants or small children weighing less than 18 kilograms (40 pounds).

B150C01A-AAT

Larger Children

It is recommended that all children who are too large for child seats occupy the rear seat and use the available lap/shoulder belts. The lap portion should be fastened snug on the hips and as low as possible. Check belt fit periodically. A child's squirming could move the belt out of position.

If the larger child (over age 13) is in the front seat, the child should be securely restrained by the seat belt. Under no circumstances should the child be allowed to stand or kneel on the seat. Children are afforded the most safety in

the event of an accident when they are restrained by a proper restraint system in the rear seat.

B150D01A-AAT

Pregnant Women

The use of a seat belt is recommended for pregnant women to lessen the chance of injury in an accident. When a seat belt is used the lap belt portion, it should be placed as low and snugly as possible on the hips, not across the abdomen. For specific recommendations, consult a physician.

B150E01A-AAT

Injured Person

A seat belt should be used when an injured person is being transported. When this is necessary, you should consult a physician for recommendations.

ZB090F1-A

One Person Per Belt

Two people (including children) should never attempt to use a single seat belt. This could increase the severity of injuries in case of an accident.

B150Q01AAAT

Do Not Lie Down

To reduce the chance of injuries in the event of an accident, and to achieve maximum effectiveness of the restraint system, all passengers

FEATURES OF YOUR HYUNDAI

should be sitting up and the front seats should be in an upright position when the car is moving. A seat belt cannot provide proper protection if the person is lying down in the rear seat or if the front seat is in a reclined position.

WARNING:

Sitting in a reclined position or lying down when your vehicle is in motion can be dangerous. Even if you buckle up, your safety belts can't do their job when you're reclined. The shoulder belt can't do its job because it won't be against your body. Instead, it will be in front of you. In a crash you could go into it, receiving serious neck or other injuries.

The lap belt can't do its job either. In a crash the belt could go up over your abdomen. The belt forces would be there, not at your pelvic bones.

This could cause serious internal injuries. For proper protection when the vehicle is in motion, have the seatback upright. Then sit back in the seat and wear your safety belt properly.

B160A01A-AAT

CARE OF SEAT BELTS

Seat belt systems should never be disassembled or modified. In addition, care should be taken to assure that seat belts and belt hardware are not damaged by seat hinges, doors or other abuse.

WARNING:

When you return the rear seatback to its upright position after the rear seatback was folded down, be careful not to damage the seat belt webbing or buckle. Be sure that the webbing or buckle does not get caught or pinched in the rear seat.

B160B01A-AAT

Periodic Inspection

It is recommended that all seat belts be inspected periodically for wear or damage of any kind. Parts of the system that are damaged should be replaced as soon as possible.

B160C01A-AAT

Keep Belts Clean and Dry

Seat belts should be kept clean and dry. If belts become dirty, they can be cleaned using a mild soap solution and warm water. Bleach, dye, strong detergents or abrasives should not be used because they may damage and weaken the fabric.

B160D01A-AAT

When to Replace Seat Belts

Entire in-use seat belt assembly or assemblies should be replaced if the vehicle has been involved in an accident. This should be done even if no damage is visible. Additional questions concerning seat belt operation should be directed to your Hyundai Dealer.

AB9SOA3-B

HEIGHT ADJUSTABLE FRONT SEAT SHOULDER BELT (If installed)

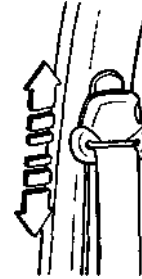

You can adjust the height of the shoulder belt anchor to one of the 4 positions.

If the height of the adjusting seat belt is too near your neck, you will not be getting the most effective protection. The shoulder portion should be adjusted so that it lies across your chest and midway over your shoulder nearest the door and not your neck.

To adjust the height of seat belt anchor, lower or raise the height adjuster into an appropriate position when the height adjuster button is pushed.

Release the button to lock the anchor into position. Try sliding the release button to make sure that it has locked into the position.

FEATURES OF YOUR HYUNDAI

WARNING:

- o The height adjuster must be in the locked position whenever the vehicle is moving.
- o There is an adjustment of height of the shoulder belt could reduce the effectiveness of the seat belt in a crash.

B180A01A-GAT

SEAT BELTS-Driver's 3-Point System with Emergency Locking Retractor To Fasten Your Belt

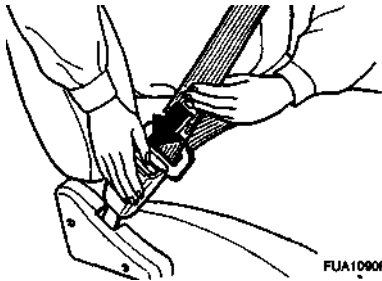

To fasten your seat belt, pull it out of the retractor and insert the metal tab into the buckle. There will be an audible "click" when the tab locks into the buckle.

The seat belt automatically adjusts to the proper length only after the lap belt is adjusted manually so that it fits snugly around your hips. If you lean forward in a slow, easy motion, the belt will extend and let you move around. If

there is a sudden stop or impact, however, the belt will lock into position. It will also lock if you try to lean forward too quickly. Check to make sure that the belt is properly locked and that the belt is not twisted.

B200A01S-QAT

Adjusting Your Seat Belt



You should place the belt as low as possible on your hips, not on your waist. If the belt is located too high on your body, you could slide under it in case of accident or a sudden stop. This could result of death, serious injury or property damage. Both arms should not be under or over the belt. Rather, one should be over and the other under, as shown in the illustration.

Never wear the seat belt under the arm nearest the door.

B210A01A-AAT

To Release the Seat Belt

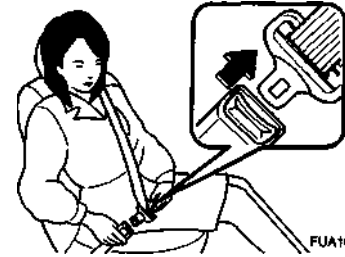

The seat belt is released by pressing the release button in the locking buckle. When it is released, the belt should automatically draw back into the retractor.

If this does not happen, check the belt to be sure it is not twisted, then try again.

(R.
Ta

rr
ai
b)
to

FEATURES OF YOUR HYUNDAI

B220A01A-AAT

SEAT BELTS (2-Point Static Type) (Rear Seat Center) To Fasten Your Seat Belt

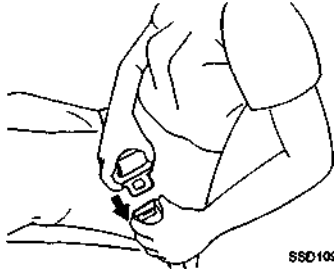

To fasten a 2-point static type belt, insert the metal tab into the locking buckle. There will be an audible "click" when the tab locks into the buckle. Check to make sure the belt is properly locked and that the belt is not twisted.

B220B01A-AAT

Adjusting Your Seat Belt

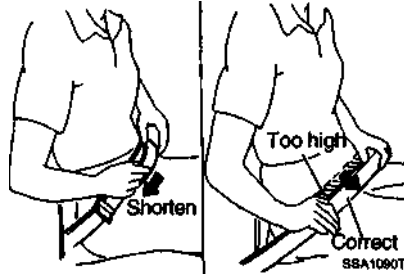

With a 2-point static type seat belt, the length must be adjusted manually so it fits snugly around your body. Fasten the belt and pull on the loose end to tighten. The belt should be placed as low as possible on your hips, not on your waist. If the belt is too high, it could increase the possibility of your being injured in an accident.

B220C01A-AAT

To Release the Seat Belt

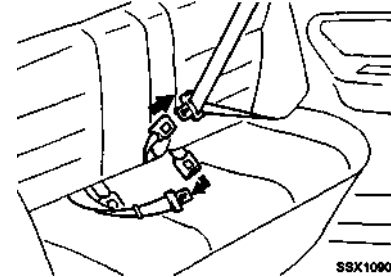

When you want to release the seat belt, press the button in the locking buckle.

WARNING

The center lap belt latching mechanism is different from those for the rear seat shoulder belts. When fastening the rear seat shoulder belts or the center lap belt, make sure they are inserted into the correct buckle to obtain maximum protection from the seat belt system and assure proper operation.

FEATURES OF YOUR HYUNDAI

B230A01A-GAT

CHILD RESTRAINT SYSTEM

(If installed)

Children riding in the car should sit in the rear seat and must always be restrained to minimize the risk of injury in an accident, sudden stop or sudden maneuver. According to accident statistics, children are safer when properly restrained in the rear seats than in the front seat. Larger children should use one of the seat belts provided.

You are required by law to use safety restraints for children. If small children ride in your vehicle you must put them in a child restraint system (safety seat).

For smaller children, you must use a commercially available child restraint system that meets the requirements of ECE-R(Economic Commission of Europe-Regulation)-16.

Children could be injured in a crash if their restraints are not properly secured. For small children and babies, a child seat or infant seat must be used. Before buying a particular child restraint system, make sure it fits your car seat and seat belts, and fits your child. Follow all the instructions provided by the manufacturer when installing the child restraint system.

WARNING:

- o **A child restraint system must be placed in the rear seat. Never install a child or infant seat on the front passenger's seat. Should an accident occur and cause the**

passenger side airbag to deploy, it could severely injure or kill an Infant or child seated in an infant or child seat Thus, only use a child restraint in the rear seat of your vehicle.

- o Since a safety belt or child restraint system can become very hot if it is left in a closed vehicle, be sure to check the seat cover and buckles before placing a child there.
- o When the child restraint system is not in use, store it in the trunk or fasten it with a safety belt so that it will not be thrown forward in the case of a sudden stop or an accident.
- o Children who are too large to be in a child restraint should sit in the rear seat and be restrained with the available lap/shoulder belts.
- o Always make sure that the shoulder belt portion of the outboard lap/shoulder belt is positioned midway over the shoulder, never across the neck. Moving the child closer to the center of the vehicle may help provide a good shoulder belt fit. The lap belt portion of the lap/shoulder belt or the center seat lap belt must always be positioned as low as possible on the child's hips and as snug as possible.
- o If the seat belt will not properly fit the child, we recommend the use of an approved booster seat in the rear seat in order to raise the child's seating height so that the seat belt will properly fit the

child. Before purchasing a booster seat, make sure that it meets applicable ECE R-16 and that it is satisfactory for use with this vehicle.

- o Never allow a child to stand up or kneel on the seat.
- o Never use an infant carrier or child safety seat that "hooks" over a seatback; it may not provide adequate security in an accident.
- o Never allow a child to be held in a person's arms while they are in a moving vehicle, as this could result in serious injury to the child in the event of an accident or a sudden stop. Holding a child in a moving vehicle does not provide the child with any means of protection during an accident, even if the person holding the child is wearing a seat belt.

FEATURES OF YOUR HYUNDAI

8230601E-GAT

Using a Child Restraint System

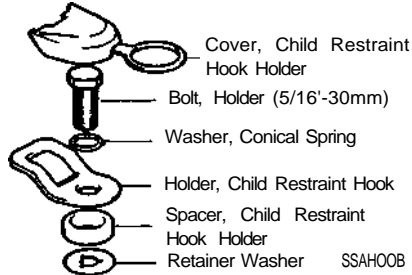

For small children and babies, the use of a child seat or infant seat is strongly recommended. This child seat or infant seat should be of appropriate size for the child and should be installed in accordance with the manufacturer's instructions. It is further recommended that the seat be placed in the vehicle's rear seat since this can make an important contribution to safety. Your vehicle is provided with three holes for installing the child restraint anchor fittings. The anchorage nut is welded beneath the sheet metal to permit installation of a child restraint anchorage fitting for a child seat, as shown in the illustration.

B230C01A-QAT

Child Restraint Hook Holder Nut Location (4 Door)

Rear seat package tray

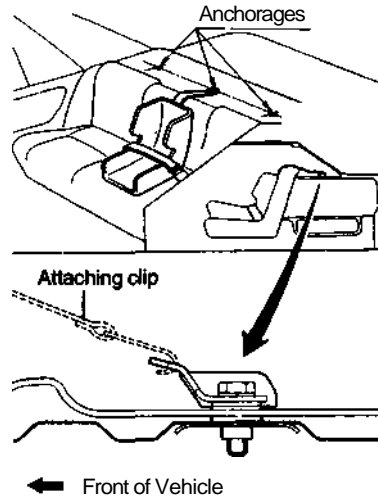

Three child restraint hook holder nuts are located on the rear seat package tray and the anchor holes are covered with plugs. If you want to install a child restraint system hook holder, remove one of the 3 anchorage trim plugs from the rear seat package tray trim,

then install the hook holder for your child restraint system with the bolt and spacer and torque to 1.7-2.6 kgf.m (12.3-18.8 lb.ft, 16.7-25.5 N.m)

B230E01A-GAT

Child Restraint Hook Holder Nut Location (3/5 Door)

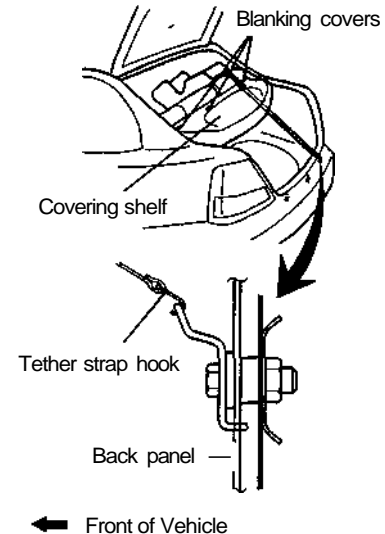

FEATURES OF YOUR HYUNDAI

Three child restraint hook holder nuts are located on the back panel.

If you want to install a child restraint system hook holder, remove one of the 3 anchorage trim plugs from the back panel, then install the hook holder for your child restraint system with the bolt and spacer and torque to 1.7-2.6 kgf.m (12.3-18.8 lb.ft, 16.7-25.5 N.m).

B230G01A-GAT

Installation on Outboard Rear Seats

On outboard rear seats

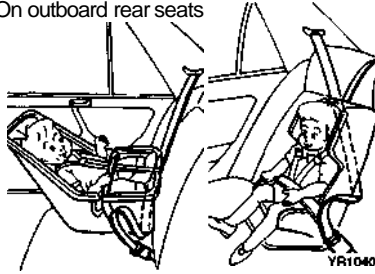

To install a child restraint system in the outboard rear seats, extend the shoulder/lap belt from its retractor. Install the child restraint system, buckle the seat belt and allow the seat belt to take up any slack. Make sure that the lap portion of the belt is tight around the child restraint system and the shoulder portion of the belt is positioned so that it cannot interfere with the child's head or neck. After installation of the child restraint system, try to move it in all

directions to be sure the child restraint system is securely installed.

If you need to tighten the belt, pull more webbing toward the retractor. When you unbuckle the seat belt and allow it to retract, the retractor will automatically revert back to its normal seated passenger emergency locking usage condition.

NOTE:

- o Before installing the child restraint system, read the instructions supplied by the child restraint system manufacturer.
- o If the seat belt does not operate as described, have the system checked immediately by your authorized Hyundai dealer.

WARNING:

Do not install any child restraint system in the front passenger seat. Should an accident occur and cause the passenger side airbag to deploy, it could severely injure or kill an infant or child seated in an infant or child seat. Therefore, only use a child restraint system in the rear seat of your vehicle.

B230H01A-QAT

Child Seat Restraint Suitability For Seat Position

Use child safety seats that have been officially approved and are appropriate for your children. Child safety seats are classified into the following four groups according to ECE-R-16.

Group 0 : Up to 10 kg (0 - 9 months)

Group 0+ : Up to 13 kg (0 - 2 years)

Group 1: 9kg to 18kg (9 months ~ 4 years)

Group II & III: 15kg to 36kg (4 ~ 12 years)

A child safety seat that has passed tests subject to ECE-R-16 is inscribed with an identification mark: ECE-R-16 (Capital E is circled and Inspection numbers).

Age Group	Seating Position		
	Front Passenger	Rear Outboard	Rear Center
0 : Up to 10 kg (0 ~ 9 months)	X	X	X
0+ : Up to 13 kg (0 - 2 years)	X	U	X
I : 9kg to 18kg (9 months - 4 years)	UF	U	UF
II & III : 15kg to 36kg (4 - 12 years)	UF	UF	UF

U : Suitable for "universal" category restraints approved for use in this mass group

UF : Suitable for forward-facing "universal" category restraints approved for use in this mass group

X : Seat position not suitable for children in this mass group

FEATURES OF YOUR HYUNDAI

B180B01A-GAT

Pre-tensioner Seat Belt (Without A/BAG)

Ordinarily the pre-tensioner seat belt operates in the same way as E.L.R (Emergency Locking Retractor) type (When vehicles stop suddenly, the belt will lock into the position. It will also lock if you try to lean forward too quickly.). However, when vehicles crash, the retractor rewinds the belt webbing. This will restrain the passenger movement quickly and also reduce the slack between passenger and belt webbing.

NOTE:

- o When the pre-tensioner seat belt is activated, there may be an explosion noise. This noise is normal and is not hazardous.
- o Pre-tensioner seat belt is designed to operate only when a sufficiently severe impact occurs and it will be only operated once.

WARNING:

If the pre-tensioner seat belt was activated, never attempt to replace it by yourself. It must be replaced by an authorized Hyundai Dealer.

B180B04A-GAT

Pre-Tensioner Seat Belt (With A/BAG)

Your Hyundai vehicle is equipped with driver's and front Passenger's pre-tensioner seat belts. The purpose of the pre-tensioner is to make sure that the seat belts fit tightly against the occupant's body in certain frontal collisions. The pre-tensioner seat belts can be activated alone or, where the frontal collision is severe enough, together with the airbags.

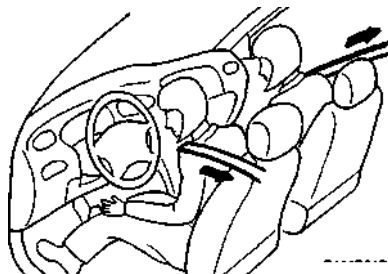

The pre-tensioner seat belt operates in the same way as an Emergency Locking Retractor (ELR) type of seat belt. When the vehicle stops suddenly, or if the occupant tries to lean forward too quickly, the seat belt retractor will lock into position. However, in certain frontal collisions, the pre-tensioner will activate and pull the seat belt into tighter contact against the occupant's body.

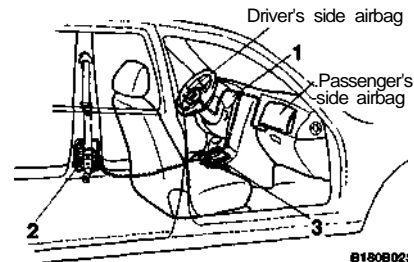

The seat belt pre-tensioner system consists mainly of the following components. Their locations are shown in the illustration.

1. SRS airbag warning light
2. Seat belt pre-tensioner assembly
3. SRS control module

WARNING:

To obtain maximum benefit from a pre-tensioner seat belt:

1. The seat belt must be worn correctly.
2. The seat belt must be adjusted to the correct position.

NOTE:

- o Both the driver's and front passenger's pre-tensioner seat belts will be activated in certain frontal collisions. The pre-tensioner seat belts can be activated alone or, where the frontal collision is

FEATURES OF YOUR HYUNDAI

severe enough, together with the airbags. The pre-tensioners will be activated under these conditions even if the seat belts are not being worn at the time of the collision.

- o When the pre-tensioner seat belts are activated, a loud noise may be heard and fine dust, which may appear to be smoke, may be visible in the passenger compartment. These are normal operating conditions and are not hazardous.
- o Although it is harmless, the fine dust may cause skin irritation and should not be breathed for prolonged periods. Wash your hands and face thoroughly after an accident in which the pre-tensioner seat belts were activated.

CAUTION:

- o Because the sensor that activates the SRS airbag is connected with the pre-tensioner seat belt, the SRS airbag warning light on the instrument panel will blink for approximately 6 seconds after the ignition key has been turned to the "ON" or "ACC" positions, and then it should turn off.
- o If the pre-tensioner seat belt is not working properly, this warning light will illuminate even if there is no malfunction of the SRS airbag system. If the SRS airbag warning light does not illuminate when the ignition key is turned to "ON" or "ACC", or if it remains illuminated

after blinking for approximately 6 seconds, or if it illuminates while the vehicle is being driven, please have an authorized Hyundai dealer inspect the pre-tensioner seat belt or SRS airbag system as soon as possible.

WARNING:

- o Pre-tensioners are designed to operate only one time. After activation, pre-tensioner seat belts must be replaced. All seat belts, of any type, should always be replaced after they have been worn during a collision.
- o The pre-tensioner seat belt assembly mechanisms become hot during activation. Do not touch the pre-tensioner seat belt assemblies for several minutes after they have been activated.
- o Do not attempt to inspect or replace the pre-tensioner seat belts yourself. This must be done by an authorized Hyundai dealer.
- o Do not strike the pre-tensioner seat belt assemblies.
- o Do not attempt to service or repair the pre-tensioner seat belt system in any manner.
- o Improper handling of the pre-tensioner seat belt assemblies, and failure to heed the warnings to not strike, modify, inspect, replace, service or repair the pre-tensioner seat belt assemblies may lead to improper operation or inadvertent activation and serious injury.

- o Always wear the seat belts when driving or riding in a motor vehicle.

B240A01F-GAT

SUPPLEMENTAL RESTRAINT (AIRBAG) SYSTEM (If Installed)

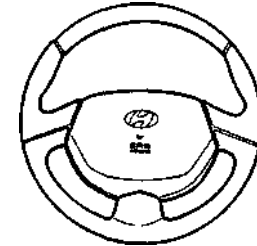

Your Hyundai is equipped with a Supplemental Restraint (Airbag) System. The indications of the system's presence are the letters "SRS AIR BAG" embossed on the airbag pad cover in the steering wheel and the passenger's side front panel pad above the glove box.

The Hyundai SRS consists of airbags installed under the pad covers in the center of the steering wheel and the passenger's side front panel above the glove box. The purpose of the SRS is to provide the vehicle's driver and/or the front passenger with additional protection than that offered by the seat-belt system alone, in

FEATURES OF YOUR HYUNDAI

j of a frontal impact of sufficient severity.

FE:

I sure to read information about the SRS i the labels provided on the backside of i sun visor and in the glove box.

WARNING:

As its name implies, the SRS is designed to work with, and be supplemental to, the driver's and the passenger's three point seat belt systems and is not a substitute for them. Therefore your seat belts must be worn at all times while the vehicle is in motion. In addition, the airbags deploy only in certain frontal impact conditions severe enough to likely cause significant injury to the vehicle occupants.

The SRS is designed to deploy the airbags only when an impact is sufficiently severe and when the impact angle is less than 30° from the forward longitudinal axis of the vehicle and will not deploy in side, rear or rollover impacts. Additionally, the airbags will only deploy once.

Thus, seat belts must be worn at all times.

For maximum safety protection in all types of crashes, all occupants including the driver should always wear their seat belts whether or not an airbag is also provided at their seating position to minimize the risk of severe injury or death in the event of a crash. Do not sit or lean

unnecessarily close to the airbag while the vehicle is in motion.

- o The SRS airbag system must deploy very rapidly to provide protection in a crash. If an occupant is out of position because of not wearing a seat belt, the airbag may forcefully contact the occupant causing serious or fatal injuries.

B240B02A-AAT

SRS Components and Functions

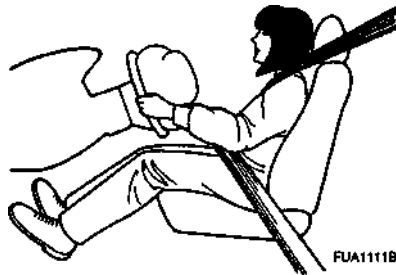

The SRS consists of the following components:

- Driver's Side Airbag Module
- Passenger's Side Airbag Module
- Knee Bolster
- SRS Service Reminder Indicator (SRI)
- SRS Control Module (SRSCM)

The SRSCM continually monitors all elements while the ignition is "ON" to determine if a frontal or near-frontal impact is severe enough to require airbag deployment.



The SRS service reminder indicator (SRI) on the instrument panel will blink for about 6 seconds after the ignition key is turned to the "ON" position or after the engine is started, after which the SRI should go out.

FEATURES OF YOUR HYUNDAI



The airbag modules are located both in the center of the steering wheel and in the front passenger's panel above the glove box. When the SRSCM detects a considerable impact to the front of the vehicle, it will automatically deploy the airbags.

Passenger's side Airbag

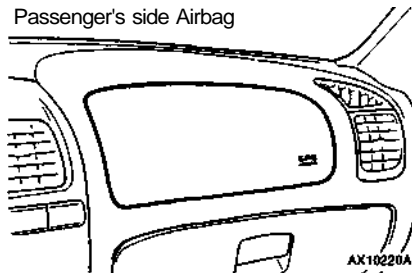

Upon deployment, tarseams molded directly into the pad covers will separate under pres-

1-20

sure from the expansion of the airbags. Further opening of the covers then allows full inflation of the airbags.

A fully inflated airbag in combination with a property worn seat belt slows the driver's or the passenger's forward motion, thus reducing the risk of head and chest injury.

After complete inflation, the airbag immediately starts deflating, enabling the driver to maintain forward visibility.

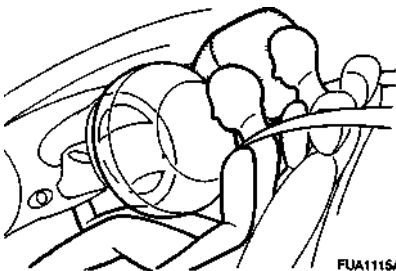

CAUTION:

When installing a container of liquid air freshener inside a vehicle, do not place it near the instrument cluster nor on the instrument panel pad surface. If there is any leakage from the air freshener onto these areas (instrument cluster, instrument panel pad or air ventilator), it may damage these

parts. If the liquid from the air freshener does leak onto these areas, wash them with water immediately.

WARNING:

- o When the SRS is activated, there may be a loud noise and fine dust will be released throughout the vehicle. These conditions are normal and are not hazardous. However, the fine dust generated during airbag deployment may cause skin irritation. Be sure to wash your hands and face thoroughly with lukewarm water and a mild soap after an accident in which the airbags were deployed.
- o The SRS can function only when the ignition key is in the "ON" position. If the SRS SRI does not come on, or continuously remains on, after flashing for about 6 seconds when the ignition key is turned to the "ON" position, or after the engine is started, or comes on while driving, the SRS is not working properly. If this occurs, have your vehicle immediately inspected by your Hyundai dealer.
- o Before you replace a fuse or disconnect a battery terminal, turn the ignition key to the "LOCK" position or remove the ignition key. Never remove or replace the air bag related fuse(s) when the ignition key is in the "ON" position. Failure to heed this warning will cause the SRS SRI to illuminate.

FEATURES OF YOUR HYUNDAI

B990602Y-AAT

Side Airbag (If installed)

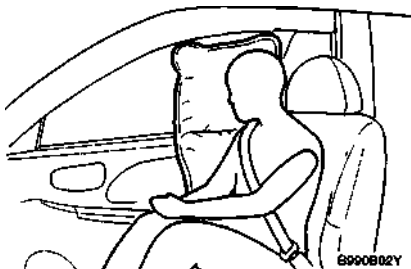

Your Hyundai is equipped with a side airbag in each front seat. The purpose of the airbag is to provide the vehicle's driver and/or the front passenger with additional protection than that offered by the seatbelt alone. The side impact airbags are designed to deploy only during certain side-impact collisions, depending on the crash severity, angle, speed and point of impact. The air bags are not designed to deploy in all side impact situations.

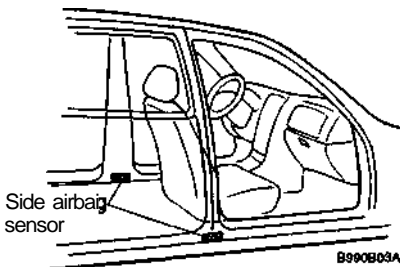

WARNING:

- o **For best protection from the side airbag system and to avoid being injured by the deploying side airbag, both front seat occupants should sit in an upright position with the seat belt properly fastened. The driver's hands should be placed on the steering wheel at the 9:00 and 3:00 o'clock positions. The passenger's arms and hands should be placed in their laps.**
- o **Do not use any accessory seat covers.**
- o **Use of seat covers could reduce the effect of the system.**
- o **Do not install any accessories on the side or near the side airbag.**
- o **Do not use excessive force on the side of the seat.**
- o **Do not place any objects over the airbag or between the airbag and yourself.**
- o **Do not place any objects (an umbrella, bag, etc.) between the front door and the**

front seat. Such objects may become dangerous projectiles and cause injury if the supplemental side air bag inflates. To prevent unexpected deployment of the side air bag that may result in personal injury, avoid impact to the side airbag sensor when the ignition key is on.

B240C01Y-GAT

SRS Care

The SRS is virtually maintenance-free and there are no parts you can safely service by yourself. The entire SRS system must be inspected by an authorized Hyundai dealer 10 years after the date that the vehicle was manufactured.

Any work on the SRS system, such as removing, installing, repairing, or any work on the steering wheel must be performed by a qualified Hyundai technician. Improper handling of the SRS system may result in serious personal injury.

FEATURES OF YOUR HYUNDAI



WARNING:

- o Extreme Hazard! Do not use a rearward facing restraint on a seat protected by an airbag in front of it.
- o Modification to SRS components or wiring, including the addition of any kind of badges to the pad covers or modifications to the body structure, can adversely affect SRS performance and lead to possible injury.
- o For cleaning the airbag pad covers, use only a soft, dry cloth or one which has been moistened with plain water. Solvents or cleaners could adversely affect the airbag covers and proper deployment of the system.
- o No objects should be placed over or near the airbag modules on the steering wheel, instrument panel, and the front passenger's panel above the glove box, because any such object could cause harm if the

vehicle is in a crash severe enough to cause the airbags to inflate.

If the airbags inflate, they must be replaced by an authorized Hyundai dealer. Do not tamper with or disconnect SRS wiring, or other components of the SRS system. Doing so could result in injury, due to accidental firing of the airbags or by rendering the SRS inoperative.

Do not install a child restraint system in the front passenger seat position. A child restraint system must never be placed in the front seat. The infant or child could be severely injured by an airbag deployment in case of an accident.

If components of the airbag system must be discarded, or if the vehicle must be scrapped, certain safety precautions must be observed. Your Hyundai dealer knows these precautions and can give you the necessary information.

Failure to follow these precautions and procedures could increase the risk of personal injury.

If you sell your vehicle, be sure to inform the new owner of these important points and make certain that this manual is transferred to the new owner.

If your car was flooded and has soaked carpeting or water on flooring, you shouldn't try to start engine; have the car towed to authorized Hyundai dealer.

FEATURES OF YOUR HYUNDAI

B250A02A QAT

INSTRUMENTS AND CONTROLS

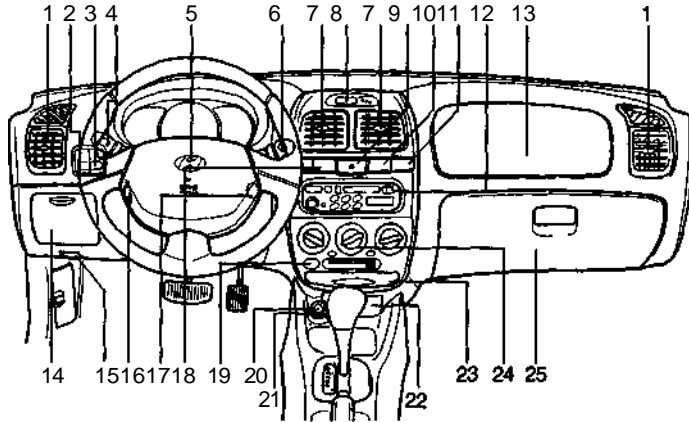

CAUTION:

When installing the container of liquid air refresher inside a vehicle, do not place it near the instrument cluster nor on the crash pad surface. If there is any leakage from the air refresher onto these areas (Instrument cluster, crash pad or air ventilator), it may damage these parts. If the liquid from air refresher does leak onto these areas, wash them with water immediately.

- | | | |
|---|--|--|
| 1. Side Air Vent Louver | 10. Front Fog Light Switch (If installed) | 18. Rear Defroster Switch (If installed) |
| 2. Headlight Leveling Device (If installed) | 11. Rear Fog Light Switch (If installed) | 19. Air Conditioning Switch (If installed) |
| 3. Rear Wiper/Washer Switch (If installed) | 12. Audio System (If installed) | 20. Cigarette Lighter |
| 4. Multi-Function Light Switch | 13. Passenger's Side Airbag (If installed) | 21. Overdrive Switch (Auto T/A only) |
| 5. Horn and Driver Side Airbag (If installed) | 14. Accessorybox | 22. Ashtray |
| 6. Windshield Wiper/Washer Switch | 15. Hood Release Lever | 23. Drink Holder |
| 7. Center Air Vent Louver | 16. Steering Wheel Tilt Lever (If installed) | 24. Heating/Air Conditioning Control Panel |
| 8. Digital Clock (If installed) | 17. Ignition Switch | 25. Glove Box |
| 9. Hazard Warning Switch | | |

FEATURES OF YOUR HYUNDAI

B260A02A-GAT

INSTRUMENT CLUSTER AND INDICATOR

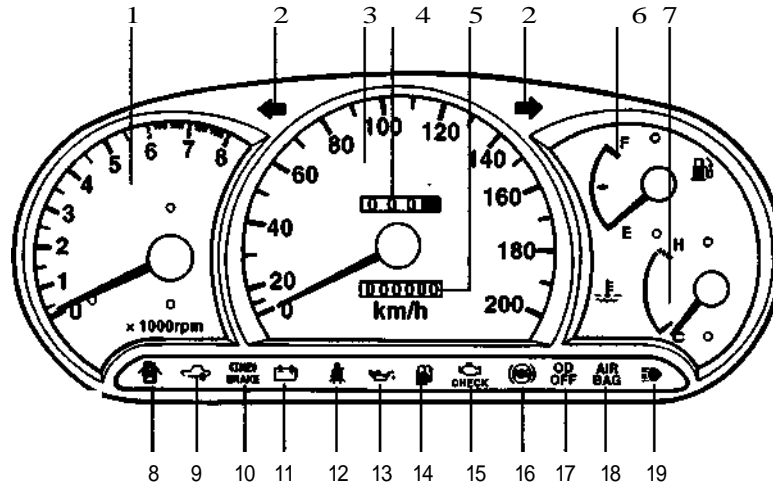

B260A01A

- | | | |
|--------------------------------|---|--|
| 1. Tachometer (If installed) | 8. Door Ajar Warning Light | 14. Low Fuel Warning Light |
| 2. Turn Signal Indicator Light | 9. Immobilizer Warning Indicator Light (If installed) | 15. Malfunction Indicator Light (MIL) (If installed) |
| 3. Speedometer | 10. Parking Brake/Brake fluid Level Warning Light | 16. ABS Service Reminder Indicator (If installed) |
| 4. Trip Odometer | 11. Charging System Warning Light | 17. Overdrive off Indicator Light (If installed) |
| 5. Odometer | 12. Seat Belt Warning Light (If installed) | 18. SRS Service Reminder Indicator (If installed) |
| 6. Fuel Gauge | 13. Oil Pressure Warning Light | 19. High Beam Indicator Light |
| 7. Temperature Gauge | | |

FEATURES OF YOUR HYUNDAI

B260C01A-AAT



O/D OFF INDICATOR (Auto T/A only)

When the overdrive switch is turned on, the overdrive off indicator will go out. This amber indicator will be illuminated when the overdrive switch is turned off (Auto T/A only).

B260D01A-AAT



TURN SIGNAL INDICATOR LIGHTS

The blinking green arrow on the instrument panel shows the direction indicated by the turn signals. If the arrow comes on but does not blink, blinks more rapidly than normal, or does not blink at all, a malfunction in the turn signal system is indicated. Your dealer should be consulted for repairs.

B260P01A-AAT



ABS SERVICE REMINDER INDICATOR (SRI) (If installed)

When the key is turned to the "ON" position, the ABS SRI will come on and then go off in a few seconds. If the ABS SRI remains on, comes on while driving, or does not come on when the key is turned to the "ON" position, this indicates that there may be a problem with the ABS.

If this occurs, have your vehicle checked by your Hyundai dealer as soon as possible. The normal braking system will still be operational, but without the assistance of the anti-lock brake system.

S260F01A-MT



HIGH BEAM INDICATOR LIGHT

The high beam indicator light comes on whenever the headlights are switched to the high beam or flash position.

B260E02A-GAT



SEAT BELT REMINDER LIGHT (If installed)

If the seat belt reminder light comes on until your seat belt is fastened when the ignition key is turned from the "OFF" position to "ON" or "START".

B260G01A-AAT



OIL PRESSURE WARNING LIGHT

CAUTION:

If the oil pressure warning light stays on while the engine is running, serious engine damage may result. The oil pressure warning light comes on whenever there is insufficient oil pressure. In normal operation, it should come on when the ignition switch is turned on, then go out when the engine is started. If the oil pressure warning light stays on while the engine is running, there is a serious malfunction.

If this happens, stop the car as soon as it is safe to do so, turn off the engine and check the oil level. If the oil level is low, add engine oil to the proper level and start the engine

again. If the light stays on with the engine running, turn the engine off immediately. In any instance where the oil light stays on when the engine is running, the engine should be checked by a Hyundai dealer before the car is driven again.

B260H02AAAT



PARKING BRAKE/BRAKE FLUID LEVEL WARNING LIGHT

CAUTION:

If you suspect brake trouble, have your brakes checked by a Hyundai dealer as soon as possible. Driving your car with a problem in either the brake electrical system or brake hydraulic system is dangerous, and could result in serious injury or death.

Warning Light Operation

The parking brake/brake fluid level warning light should come on when the parking brake is applied and the ignition switch is turned to "ON" or "START". After the engine is started, the light should go out when the parking brake is released.

If the parking brake is not applied, the warning light should come on when the ignition switch is turned to "ON" or "START", then go out when the engine starts. If the light comes on at any other time, you should slow the vehicle and bring it to a complete stop in a safe location off

FEATURES OF YOUR HYUNDAI

the roadway.

The brake warning light indicates that the brake fluid level in the brake master cylinder is low and brake fluid conforming to DOT 3 specifications should be added. After adding fluid, if no other trouble is found, the car should be immediately and carefully driven to a Hyundai dealer for inspection. If further trouble is experienced, the vehicle should not be driven at all but taken to a dealer by a professional towing service.

Your Hyundai is equipped with dual-diagonal braking systems. This means you still have braking on two wheels even if one of the dual systems should fail. With only one of the dual systems working, more than normal pedal travel and greater pedal pressure are required to stop the car. Also, the car will not stop in as short a distance with only a portion of the brake system working. If the brakes fail while you are driving, shift to a lower gear for additional engine braking and stop the car as soon as it is safe to do so.

B260J01S-GAT

CHARGING SYSTEM WARNING LIGHT

The charging system warning light should come on when the ignition is turned on, then go out when the engine is running. If the light stays on while the engine is running, there is a malfunction in the electrical charging system. If the light

comes on while you are driving, stop, turn off the engine and check under the hood. First, make certain the alternator drive belt is in place. If it is, check the tension of the belt. And then, have the system checked by your Hyundai dealer.

CAUTION:

If the drive belt (generator belt) is loosen, broken, or misslon while the vehicle is driving, there may be a serious malfunction, engine could overheat because this belt also drives the water pump.

B260L01A-GAT

DOOR AJAR WARNING LIGHT

The door ajar warning light warns you that a door is not completely closed.

B260M01A-AAT

LOW FUEL LEVEL WARNING LIGHT

The low fuel level warning light comes on when the fuel tank is approaching empty. When it comes on, you should add fuel as soon as possible. Driving with the fuel level warning light on or with the fuel level below "E" can cause the engine to misfire and damage the catalytic converter.

B260B01S-GAT

SRS (Airbag) Service Reminder Indicator (SRI) (If installed)

The SRS service reminder indicator (SRI) comes on and flashes for about 6 seconds after the ignition key is turned to the "ON" position or after the engine is started, after which it will go out.

This light also comes on when the SRS is not working properly. If the SRI does not come on, or continuously remains on after flashing for about 6 seconds when you turned the ignition key to the "ON" position or started the engine, or if it comes on while driving, have the SRS inspected by an authorized Hyundai Dealer.

B270A01A-AAT

BRAKE PAD WEAR WARNING SOUND

The front disc brake pads have wear indicators that should make a high-pitched squealing or scraping noise when new pads are needed. The sound may come and go or be heard all the time when the vehicle is moving. It may also be heard when the brake pedal is pushed down firmly. Expensive rotor damage will result if the worn pads are not replaced. See your Hyundai dealer immediately.

FEATURES OF YOUR HYUNDAI

B260N01A-AAT

Malfunction Indicator Light (If installed)

This light illuminates when there is a malfunction of an exhaust gas related component, and the system is not functioning properly so that the exhaust gas regulation values are not satisfied. This light will also illuminate when the ignition key is turned to the "ON" position, and will go out in a few seconds. If it illuminates while driving, or does not illuminate when the ignition key is turned to the "ON" position, take your car to your nearest authorized Hyundai dealer and have the system checked.

B900A01A-GAT

ACOUSTIC WARNING SOUND (If Installed)

The acoustic warning chime sounds when the tail lights are on and the door in driver side is open. This prevents the battery from discharging when the car is left with the tail lights on. The chime sounds until the tail lights are turned off.

B280A01A-AAT

FUEL GAUGE



The needle on the gauge indicates the approximate fuel level in the fuel tank. The fuel capacity is given in Section 9.

B290A02A-AAT

ENGINE COOLANT TEMPERATURE GAUGE

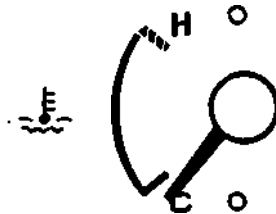

WARNING:

Never remove the radiator cap when the engine is hot. The engine coolant is under pressure and could erupt and cause severe burns. Wait until the engine is cool before removing the radiator cap.

The needle on the engine coolant temperature gauge should stay in the normal range. If it moves across the dial to "H" (Hot), pull over and stop as soon as possible and turn off the engine. Then open the hood and check the coolant level and the water pump drive belt. If you suspect cooling system trouble, have your cooling system checked by Hyundai dealer as soon as possible.

B300A01A-GAT

SPEEDOMETER

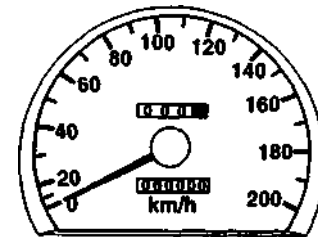

AX10460A

Your Hyundai's speedometer is calibrated in kilometers per hour or miles per hour.

FEATURES OF YOUR HYUNDAI

B310A01A-GAT

ODOMETER

The odometer records the total driving distance in kilometers or miles, and is useful for keeping a record for maintenance intervals.

NOTE:

Any alteration of the odometer may void your warranty coverage.

B320A01A-GAT

TRIP ODOMETER

The trip odometer may be used to conveniently record trip distances. Push the reset knob to set the counter to zero.

B330A02A-AAT

TACHOMETER (If installed)

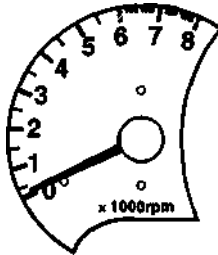

The tachometer registers the speed of your engine in revolutions per minute (rpm). It is useful to help you shift at the appropriate engine

speed to avoid lugging or over-revving the engine.

CAUTION:

The engine should not be raced to such a speed that the needle enters the red zone on the tachometer face. This can cause severe engine damage and may void your warranty.

B340A01A AAT

COMBINATION TURN SIGNAL, HEADLIGHT AND LOW-BEAM SWITCH

Turn Signal Operation

Pulling down on the lever causes the turn signals on the left side of the car to blink. Pushing upward on the lever causes the turn signals on the right side of the car to blink. As the turn is completed, the lever will automatically return to the center position and turn off the turn signals at the same time. If either turn signal indicator light blinks more rapidly than usual, goes on but does not blink, or does not go on at all, there is a malfunction in the system. Check for a burned-out fuse or bulb or see your Hyundai dealer.

B340B01A-AAT

Lane Change Signal

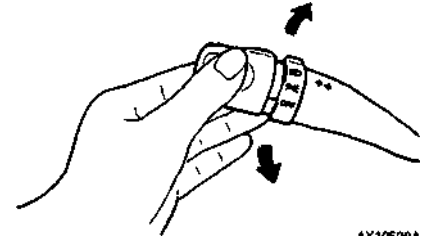

To indicate a lane change, move the lever up or down to a point where it begins flashing. The lever will automatically return to the center position when released.

B340C01A-AAT

Headlight Switch

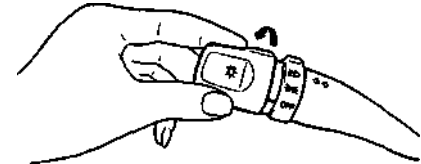

FEATURES OF YOUR HYUNDAI

To operate the headlights, turn the barrel on the end of the multi-function switch. The first position turns on the parking lights, sidelights, tail lights and instrument panel lights. The second position turns on the headlights.

B340F01A-QAT

Daytime Running Lights (If installed)

Your Hyundai is equipped with daytime running lights. The daytime running lights are used to improve visibility for oncoming traffic. Your vehicle daytime running lights are designed to remain on continuously when the engine is operating even though the headlight switch is in the "OFF" position. However, the daytime running lights will be off while the parking brake is applied.

B340D01A-AAT

High-Beam Switch

To turn on the headlight high beams, push the lever forward (away from you). The High Beam Indicator Light will come on at the same time. For low beams, pull the lever back toward you.

B340E01A-AAT

Headlight Flasher

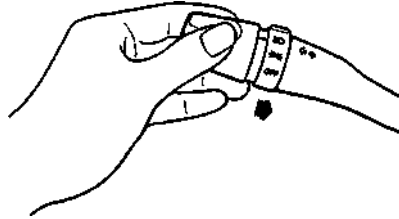

To flash the headlights, pull the switch lever toward you, then release it. The headlights can be flashed even though the headlight switch is in the "OFF" position.

B350A01A-AAT

WINDSHIELD WIPER AND WASHER SWITCH

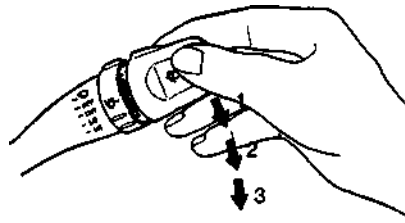

The windshield wiper switch has three positions:

1. Intermittent wiper operation (If installed)
2. Low-speed operation
3. High-speed operation

NOTE:

To prevent damage to the wiper system, do not attempt to wipe away heavy accumulations of snow or ice. Accumulated snow and ice should be removed manually. If there is only a light layer of snow or ice, operate the heater in the defrost mode to melt the snow or ice before using the wiper.

B350A02A-GAT

WINDSHIELD WASHER OPERATION

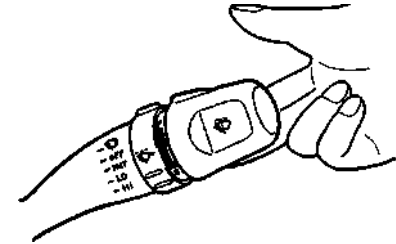

To use the windshield washer, pull the wiper/washer lever toward the steering wheel.

If your vehicle is equipped with the intermittent feature, the washer fluid is sprayed onto the

FEATURES OF YOUR HYUNDAI

glass and the wipers automatically make two passes across the windshield until the lever is released.

If your vehicle is not equipped with the intermittent feature, only washer fluid is sprayed onto the glass until the lever is released.

NOTE:

- o Do not operate the washer more than 15 seconds at a time or when the fluid reservoir is empty.
- o In icy or freezing weather, be sure the wiper blades are not frozen to the glass prior to operating the wipers.
- o In areas where water freezes in winter, use windshield washer antifreeze.

Mist Wiper Operation

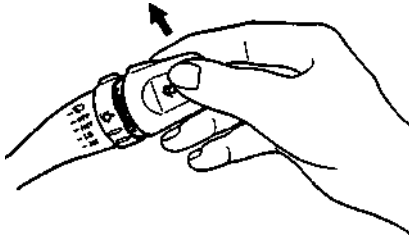

If a single wipe is desired in mist, move the windshield wiper and washer control lever up.

B360C01A-AAT

ADJUSTABLE INTERMITTENT WIPER OPERATION (If installed)

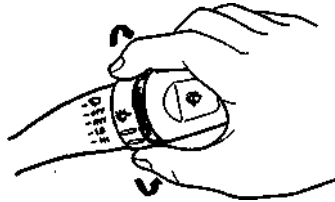

To use the intermittent wiper feature, place the wiper switch in the "INT" position. With the switch in this position, the interval between wipes can be varied in 5 positions by turning the Interval Adjuster Switch.

B390A01A-AAT

REAR WINDOW WIPER AND WASHER (If installed)

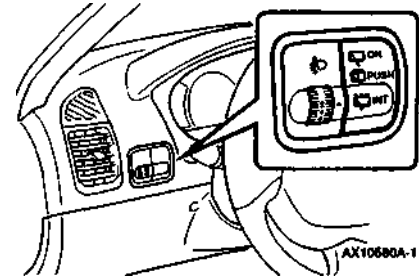

The rear wiper and washer are turned on by pushing in on the switch. Washer fluid is sprayed onto the glass as long as the switch is depressed. Do not operate the washer continuously for more than 15 seconds or when the fluid reservoir is empty; this could damage the system.

Do not operate the wiper when the window is dry; this can result in scratching as well as premature wiper blade wear. For the same reason, do not operate the washer when the washer fluid reservoir is empty.

FEATURES OF YOUR HYUNDAI

B340Q01A-GAT

HEADLIGHT LEVELING DEVICE SYSTEM (If Installed)

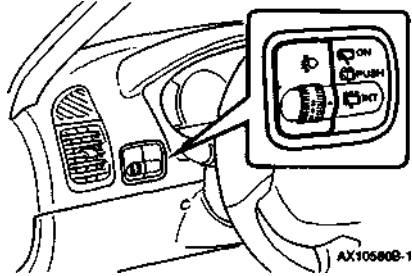

To adjust the headlight beam level according to the number of the passengers and the loading weight in the luggage area, turn the beam leveling switch.

The higher the number of the switch position, the lower the headlight beam level. Always keep the headlight beam at the proper leveling position, or headlights may dazzle other road users.

Listed below are the examples of proper switch settings. For loading conditions other than those listed below, adjust the switch position so that the beam level may be the nearest as the condition obtained according to the list.

Loading condition	Switch position
Driver only	0
Driver + front passenger	0
Full passengers (including driver)	1
Full passengers (including driver) + full trunk loading (or light trailer loading)	2
Driver + full trunk loading (or maximum trailer loading)	3

B370A01A-AAT

HAZARD WARNING SYSTEM

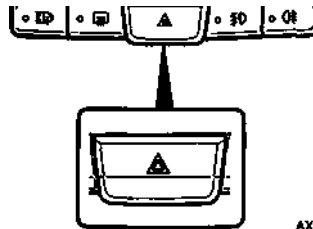

The hazard warning system should be used whenever you find it necessary to stop the car in a hazardous location. When you must make

such an emergency stop, always pull off the road as far as possible.

The hazard warning lights are turned on by pushing in on the hazard switch. This causes all turn signal lights to blink. The hazard warning lights will operate even though the key is not in the ignition.

To turn the hazard warning lights off, push in on the switch a second time.

B3B0A01A-AAT

REAR WINDOW DEFROSTER SWITCH

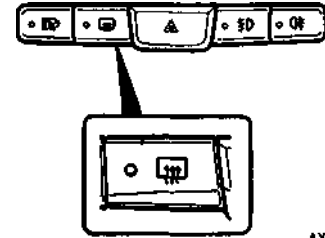

The rear window defroster is turned on by pushing in on the switch. To turn the defroster off, push in on the switch a second time. The rear window defroster automatically turns itself off after about 15 minutes. To restart the defroster cycle, push in on the switch again after it has turned itself off.

FEATURES OF YOUR HYUNDAI

CAUTION:

Do not clean the inner side of the rear window glass with an abrasive type of glass cleaner or use a scraper to remove the foreign deposits from the inner surface of the glass as this may cause damage to the defroster elements.

NOTE:

The engine must be running for the rear window defroster to operate.

B360A01A-GAT

FRONT FOG LIGHT SWITCH (If Installed)

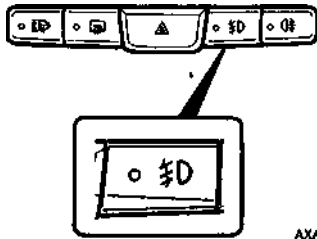

To turn on the front fog lights, push the switch. They will come on when the headlight switch is in the first or second position.

B360B01A-GAT

Rear Fog Light Switch (If installed)

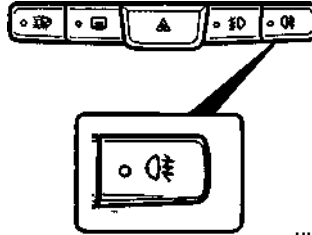

To turn on the rear fog lights, push the switch. They will come on when the headlights are turned on.

B400A01A-AAT

DIGITAL CLOCK (If installed)

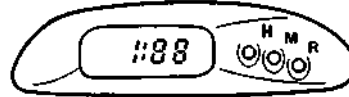

There are three control buttons for the digital clock. Their functions are:

HOUR - Push "H" to advance the hour indicated.

MIN - Push "M" to advance the minute indicated.

RESET - Push "R" to reset minutes to ":00" to facilitate resetting the clock to the correct time. When this is done:

Pressing "R" between 10 : 30 and 11 : 29 changes the readout to 11 : 00. Pressing "R" between 11 : 30 and 12 : 29 changes the readout to 12 : 00.

B420A01A-AAT

CIGARETTE LIGHTER

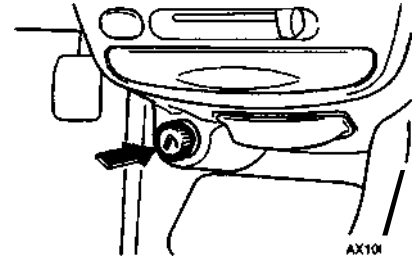

For the cigarette lighter to work, the key must be in the "ACC" position or the "ON" position. To use the cigarette lighter, push it all the way

FEATURES OF YOUR HYUNDAI

into its socket. When the element has heated, the lighter will pop out to the "ready" position. Do not hold the cigarette lighter pressed in. This can damage the heating element and create a fire hazard.

If it is necessary to replace the cigarette lighter, use only a genuine Hyundai replacement or its approved equivalent.

B430A01S-AAT

FRONT ASHTRAY

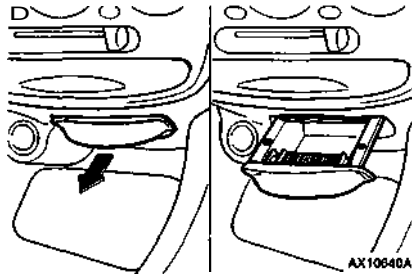

The front ashtray may be opened by pulling it out by its grip. To remove the ashtray to empty or clean it, press down on the spring-loaded tab inside the ashtray and pull it all the way out. The ashtray light will only illuminate when the external lights are on.

B440A01A-AAT

REAR ASHTRAY (If Installed)

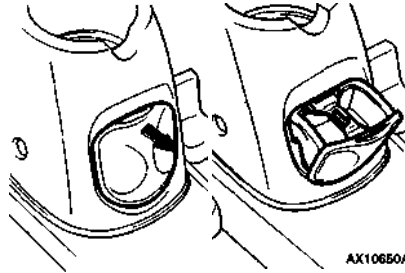

The rear ashtray may be opened by pulling it out by its top edge. To remove the ashtray to empty or clean it, lift the ashtray outward and up at the top edge.

B450A03A-AAT

DRINK HOLDER

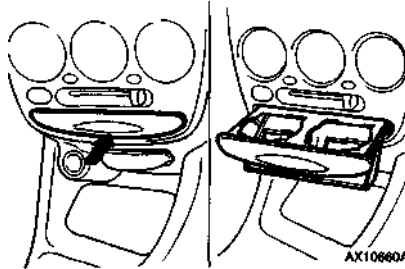

The drink holder is located on the front main console for holding cups or cans in its holes. The drink holder can be used by pushing it at its top edge.

CAUTION:

Place the drink holder in its original position while not in use.

WARNING:

Do not place anything else on the drink holder. Such objects can be thrown out, possibly injuring persons in the vehicle during sudden braking or in an accident.

B470A01A-AAT

SUNSHADE (If installed)

To remove the sunshade

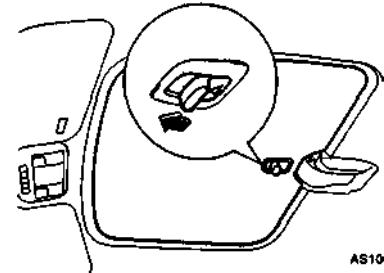

1. Pull the sunshade knob toward the front of the sunshade then pull down the rear of the sunshade.

FEATURES OF YOUR HYUNDAI

2. Then, you can easily remove the sunshade.

To install the sunshade

1. Install the hook into the holder attached on the front of the sunroof.
2. Slide and lock the sunshade into the catch.

WARNING:

Never Install or remove the sunshade while driving.

CAUTION:

- o Installation or removal of the sunshade should be done with the sunroof closed.
- o Before driving, make sure the sunshade is securely installed.

B460A01A-AAT

SUNROOF (If installed)

To Tilt Up the Sunroof

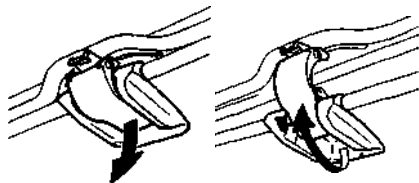

AS10670AMS10671A

The sunroof can be manually opened or closed.

1. Pull the handle down and then forward and up as indicated by the arrows in the illustration.
2. Push the handle at the center to lock the sunroof in the open position.
3. After tilting up the sunroof, make sure the handle is secure in place.

B460B02A-AAT

To Close the Sunroof

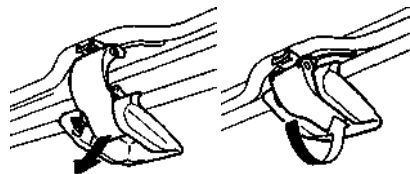

AS10672A/AS10673A

1. Pull the handle toward you.
2. After the sunroof has been closed, lock the handle back into position.
3. Be sure that the sunroof and handle are securely closed.

WARNING:

Do not close the sunroof if anyone's hands, arms or other body parts are between the

sunroof and the sunroof sash as this may cause an injury.

CAUTION:

- o Do not open the sunroof in severely cold temperatures or when it is covered with ice or snow.
- o Remove water drops, snow, ice or sand from the sunroof before opening.

B460C01A-AAT

To Remove the Sunroof

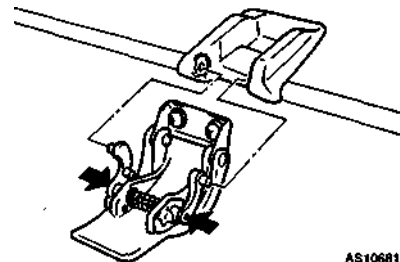

AS10681A

1. Remove the sunshade before removing the sunroof.
2. Pull the handle all the way downward.
3. Depress the handles of the base plate to release them from their holes.
4. Raise the sunroof glass from outside of the vehicle until it is perpendicular to the roof panel.

FEATURES OF YOUR HYUNDAI

- Now, you can easily remove the sunroof from the roof panel.

WARNING:

- Do not stand up or extend any portion of your body out of the opening while the vehicle is moving.
- Do not sit on top of the vehicle around the opening

B460D01A-AAT

To Install the Sunroof

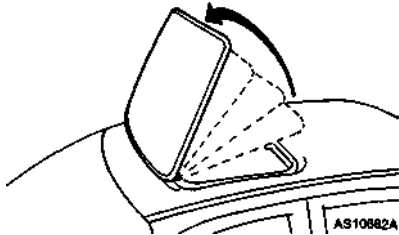

- Insert the flat hinges into the cutouts. Then supporting the sunroof with your hands, slowly lower it.
- Make sure both of the flat hinges are securely inserted into their cutouts.
- Depress the handles of the base plate and insert into the holes.

WARNING:

- Never install or remove the sunroof while driving.
- Never put your hands between the sunroof and the car's body.
- Do not drive the vehicle without being certain that the sunroof is securely locked in place.

B460E01A-AAT

Storing the Sunroof and the Sunshade

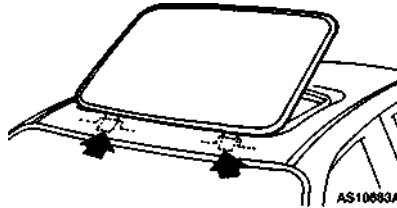

There is a storage bag in the trunk. Place the sunroof or sunshade into the storage bag and store it in the trunk.

CAUTION:

- Be careful not to place heavy objects on the bag, otherwise the sunshade or sunroof may be deformed or broken.
- When storing the sunroof and sunshade into the storage bag, put the sunshade on top of the sunroof.

B490A01A-AAT

INTERIOR LIGHT (with sunroof)

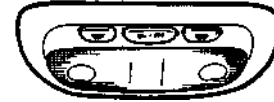

The interior courtesy light has a 3-position switch. The three positions are:

- "OFF"
In the "MIDDLE" position, the interior courtesy light comes on when any door is opened, then goes out when it is closed.
- "ON"
In the "RIGHT" position, the light stays on when a door is open.
- "ON"
In the "LEFT" position, the light stays on at all times.

FEATURES OF YOUR HYUNDAI

B490B01A-AAT

Interior Light (Without Sunroof)



B490B03A

The interior courtesy light has a 3-position switch. The three positions are:

- o "DR"
In the "MIDDLE" position, the interior courtesy light comes on when any door is opened, then goes out when it is closed.
- o "OFF"
In the "LEFT" position, the light stays off even though a door is open.
- o "ON"
In the "RIGHT" position, the light stays on at all times.

B500A01A-AAT

GLOVE BOX

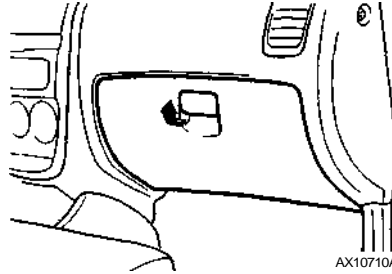

AX10710A

WARNING:

To avoid the possibility of injury in case of accident or a sudden stop, the glove box door should be kept closed when the car is in motion.

- o To open the glove box, pull on the glove box release lever.

B510A01A-AAT

OUTSIDE REAR VIEW MIRROR

Manual Type

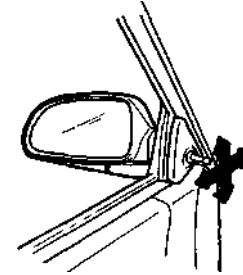

The outside rear view mirrors are equipped with a remote control for your convenience. It is operated by the control lever in the bottom front corner of the window.

Before driving away, always check that your mirrors are positioned so you can see behind you, both to the left and right sides, as well as directly behind your vehicle. When using the mirror, always exercise caution when attempting to judge the distance of vehicles behind or along side of you.

CAUTION:

If the mirror control is jammed with ice, do not attempt to break it free using the control handle or by manipulating the face of the mirror. Use an approved spray de-icer (not radiator antifreeze) to release the frozen

FEATURES OF YOUR HYUNDAI

mechanism or move the vehicle to a warm place and allow the ice to melt.

B510B01A-AAT

Electric Type (If installed)

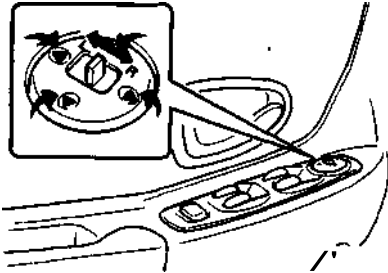

The outside rear view mirrors can be adjusted to any direction to give the maximum rear view vision.

The remote control outside rear view mirror switch controls the adjustments for both right and left door mirrors.

To adjust the position of either mirror:

1. Move the selecting switch to the right or left to activate the adjustable mechanism for the corresponding door mirror.
2. Next, adjust mirror angle by depressing the appropriate perimeter switch as illustrated.

CAUTION:

- o Do not operate the switch continuously for an unnecessary length of time.
- o Scraping ice from the mirror face could cause permanent damage. To remove any ice, use a sponge, soft cloth or approved delcer.

WARNING:

Be careful when judging the size or distance of any object seen in the passenger side rear view mirror. It is a convex mirror with a curved surface. Objects seen in this mirror are closer than they appear.

B510D01Y-AAT

OUTSIDE REARVIEW MIRROR HEATER (If installed)

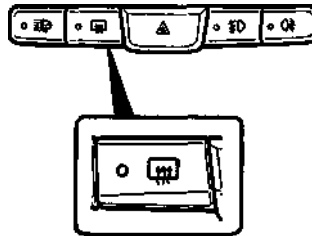

The outside rearview mirror heater is actuated in connection with the rear window defroster. To heat the outside rearview mirror glass, push

in the switch for the rear window defroster. The rearview mirror glass will be heated for defrosting or defogging and will give you improved rear vision in incimate weather conditions. Push the switch again to turn the heater off. The outside rearview mirror heater automatically turns itself off after 15 minutes.

B510C01A-AAT

FOLDING THE OUTSIDE REAR VIEW MIRRORS

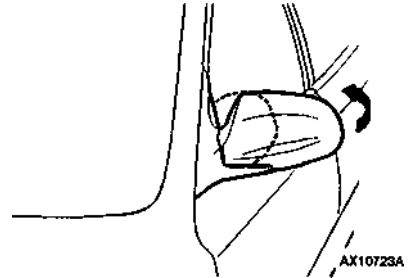

To fold the outside rear view mirrors, push them towards the rear.

The outside rear view mirrors can be folded rearward for parking in narrow areas.

WARNING:

Do not adjust or fold the outside rearview mirrors while the vehicle is moving.

FEATURES OF YOUR HYUNDAI

This could result in loss of control, and an accident which could cause death, serious injury or property damage.

B520A01A-AAT DAY/NIGHT INSIDE REAR VIEW MIRROR

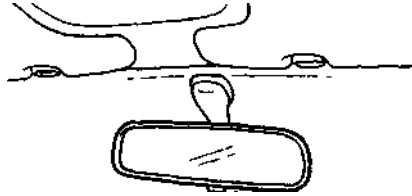

Your Hyundai is equipped with a day/night inside rear view mirror. The "night" position is selected by flipping the tab at the bottom of the mirror toward you. In the "night" position, the glare of headlights of cars behind you is reduced.

B530A01A-AAT PARKING BRAKE

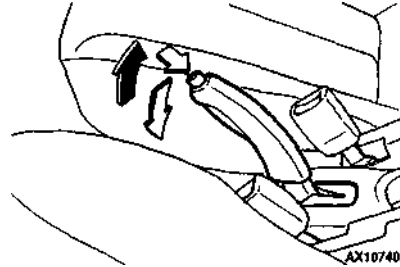

Always engage the parking brake before leaving the car. This also turns on the parking brake indicator light when the key is in the "ON" or "START" position. Before driving away, be sure that the parking brake is fully released and the indicator light is off.

- To engage the parking brake, pull the lever up as far as possible.
- To release the parking brake, pull up the lever and press the thumb button. Then, while holding the button in, lower the brake lever.

B110A02A-AAT FOLDING REAR SEAT BACKS (If installed)

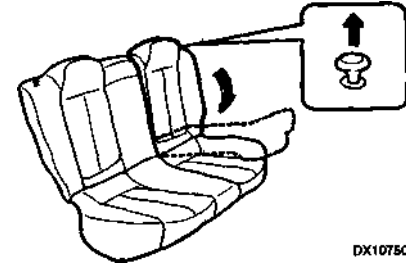

DX10750

WARNING:

The purpose of the fold-down rear seat backs is to allow you to carry longer objects than could otherwise be accommodated. Do not allow passengers to sit on top of the folded-down seat back while the car is moving as this is not a proper seating position and no seat belts are available for use when the seat backs are folded down. This could result in serious injury or death in case of an accident or a sudden stop. Objects carried on the folded-down seat back should not extend higher than the top of the front seats. This could allow cargo to slide forward and cause injury or damage during sudden stops.

FEATURES OF YOUR HYUNDAI

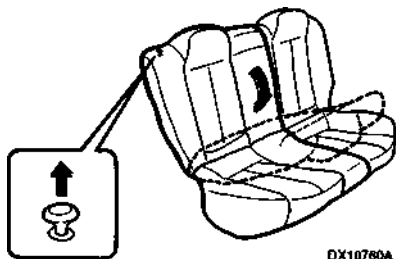

DX10760A

For greater convenience, the entire seat back may be folded down or the seat backs may be folded down individually.

- o To unlock the seat back, pull up on the seat back locking knob, then pull forward on the seat back.
- o When you return the seatback to its upright position, always be sure it has locked into position by pulling and pushing on the top of the seat back.

WARNING:

When you return the rear seatback to its upright position after being folded down, be careful not to damage the seat belt webbing or buckle. In addition, do not allow the seat belt webbing or buckle to get caught or pinched in the rear seat.

B840A02A-AAT

TAIL GATE/TRUNK LID

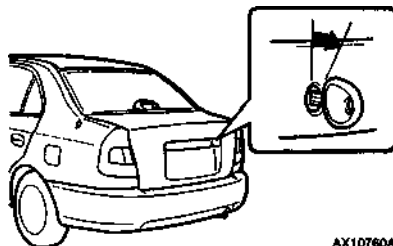

AX10760A

WARNING:

The tail gate or trunk lid should always be kept completely closed while the vehicle is in motion. If it is left open or ajar, poisonous exhaust gases may enter the car resulting in serious injury or death to the occupants. See additional warnings concerning exhaust gases on page 2-1.

- o The tail gate or trunk lid is opened by first turning the key clockwise to release the lock, then raising the door manually.
- o To close, lower the door or lid, then press down on it until it locks. To be sure the door or lid is securely fastened, always try to pull it up again.

ZB320A1 A

CARGO AREA COVER (3/5 Door Model)

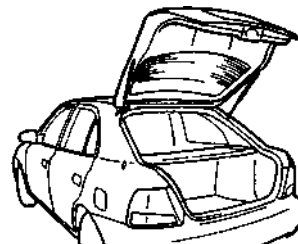

Nothing should be carried on top of the luggage cover. Loose materials could result in injury to vehicle occupants during sudden braking.

B540E01A-GAT

Trunk Lid Emergency Latch Release (If Installed)

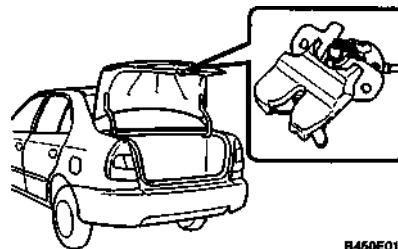

B460E01A

FEATURES OF YOUR HYUNDAI

NOTE:

- o If a person is locked in the trunk, he may pull the red painted lever on the inside latch cover. This will open the trunk lid.
- o We're recommending that cars be kept locked and keys be kept out of the reach of children, and that parents teach their children about the dangers of playing in trunks.

B540D02A-AAT

Remote Tail Gate/Trunk Lid Release (If installed)

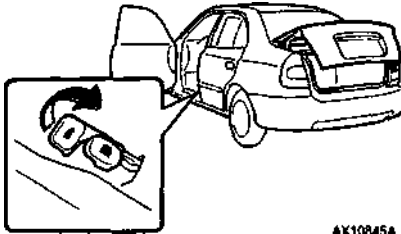

▲X10245A

The tail gate or trunk lid is opened by pulling the lever to release the lock, then raising the door or lid manually.

To close, lower the door or lid, then press down on it until it locks. To be sure the door or lid is securely fastened, always try to pull it up again.

WARNING:

The tail gate or trunk lid should always be kept completely closed while the vehicle is in motion. If it is left open or ajar, exhaust gases may enter the car and serious illness may result.

B550A01F-AAT

HIGH-MOUNTED REAR STOP LIGHT (If installed)

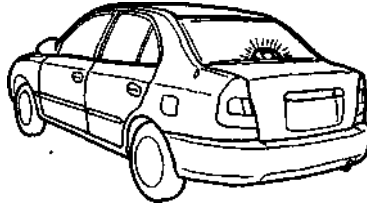

In addition to the lower-mounted rear stop lights on either side of the car, the high mounted rear stop light in the center of the rear window also comes on when the brakes are applied.

8560A01A-AAT

REMOTE FUEL-FILLER LID RELEASE

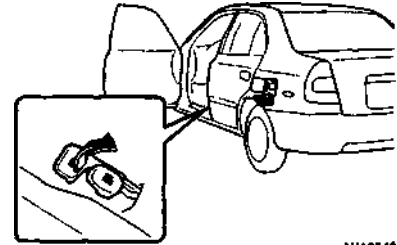

The fuel-filler lid may be opened from inside the vehicle by pulling up on the fuel-filler lid opener located on the front floor area on the left side of the car.

NOTE:

If the fuel-filler lid will not open because ice has formed around it, tap lightly or push on the lid to break the ice and release the lid. Do not pry on the lid. If necessary, spray around the lid with an approved de-icer fluid (do not use radiator anti-freeze) or move the vehicle to a warm place and allow the ice to melt.

FEATURES OF YOUR HYUNDAI

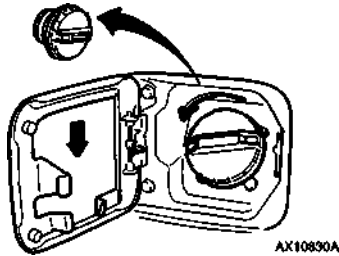

WARNING:

Gasoline vapors are dangerous. Before refueling, always stop the engine and never allow sparks or open flames near the filler area. If you need to replace the filler cap, use a genuine Hyundai replacement part. If you open the fuel filler cap during high ambient temperatures, a slight "pressure sound" may be heard. This is normal and not a cause for concern. Whenever you open the fuel filler cap, turn it slowly.

B570AOIA-GAT

HOOD RELEASE

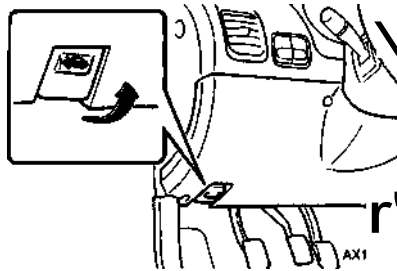

1. Pull the release knob to unlatch the hood.
2. Press the safety catch lever up and lift the hood.
3. Hold the hood open with the support rod.

Before closing the hood, return the support rod to its clip to prevent it from rattling. Lower the hood until it is about 1 ft. (30 cm) above the closed position and let it drop. Make sure that it locks into place.

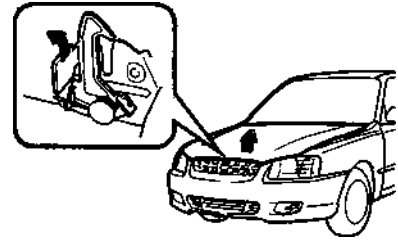

WARNING:

Make sure that the support rod has been released prior to closing the hood. Always double check to be sure that the hood is firmly latched before driving away. If it is not latched, the hood could fly open while the vehicle is being driven, causing a total loss of visibility, which might result in an accident. The support rod must be inserted completely into the hole provided in the hood whenever you inspect the engine compartment. This will prevent the hood from falling and possibly injuring you. Do not move the vehicle with the hood in the raised position, as vision is obstructed and the hood could fall or be damaged.

FEATURES OF YOUR HYUNDAI

B580A01A-AAT
SUN VISOR

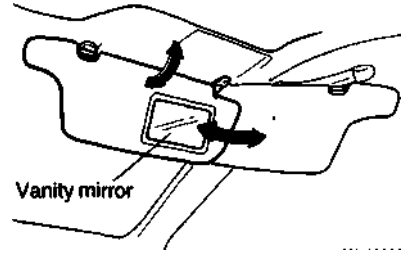

Your Hyundai is equipped with sun visors to give the driver and front passenger either frontal or sideward shade. The sun visors are fitted on both sides on all models. To reduce glare or to shut out direct rays of the sun, turn the sun visor down to block the annoyance. A vanity mirror is provided on the back of the sun visor for the front passenger.

NOTE:
The Supplemental Restraint System (SRS) label containing useful information can be found on the back of each sun visor.

CAUTION:
Do not place the sun visor in such a manner that it obscures visibility of the roadway, traffic or other objects.

B600A01A-AAT
STEERING WHEEL TILT LEVER
(If installed)

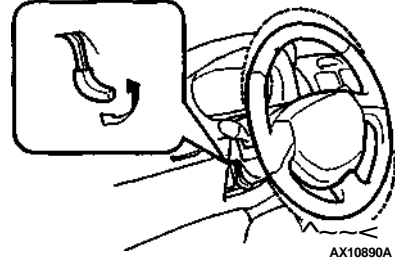

To adjust the steering wheel:

1. Push the lever downward to unlock.
2. Raise or lower the steering wheel to the desired position.
3. After adjustment, securely tighten the lever by pulling it upward.

WARNING:
Do not attempt to adjust the steering wheel while driving as this may result in loss of control of the vehicle which may cause serious injury or death.

B610A01A-QAT
HORN (With Airbag) (If installed)

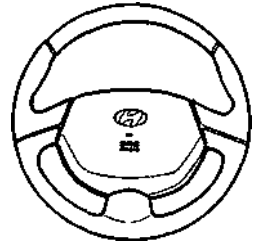

Press the pad on the steering wheel to sound the horn.

B610B01A-GAT
HORN (Without Airbag)

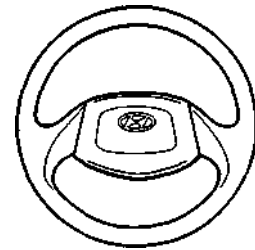

Press the pad on the steering wheel to sound the horn.

FEATURES OF YOUR HYUNDAI

B670A01A-AAT

HEATING AND VENTILATION ROTARY TYPE (If installed)

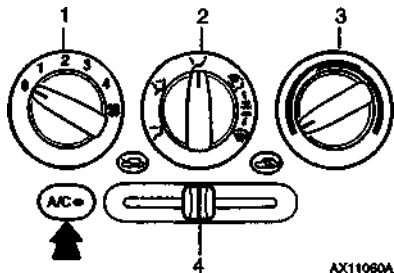

This model has four controls for the heating and cooling system. They are:

1. Fan speed control
2. Air flow control
3. Temperature control
4. Air intake control

B670B02A-AAT

FAN SPEED CONTROL (BLOWER CONTROL)

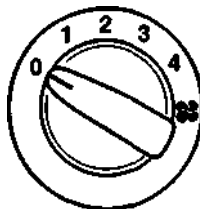

This is used to turn the blower fan on and off and to select the fan speed.

The blower fan speed, and therefore the volume of air delivered from the system, may be controlled manually by setting the blower control between the "1" and "4" position.

B670C02A-AAT

AIR INTAKE CONTROL

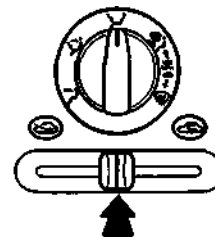

This is used to select fresh outside air or recirculation inside air.



Fresh



Recirculation

With the "P=y" mode selected, air enters the vehicle from outside and is heated or cooled according to the other functions selected.

With the "<&f" mode selected, air from within the passenger compartment is drawn through the heating system and heated or cooled according to the other functions selected.

NOTE:

It should be noted that prolonged operation of the heating system in "rgs" mode will give rise to misting of the windshield and

FEATURES OF YOUR HYUNDAI

side windows and the air within the passenger compartment will become stale. In addition prolonged use of the air conditioning with the "cEb" mode selected may result in the air within the passenger compartment becoming excessively dry.

ZB440D2-G

AIR FLOW CONTROL



This is used to direct the flow of air. Air can be directed to the floor, dashboard outlets, or windshield. Five symbols are used to represent Face, Bi-Level, Floor, Floor-Defrost and Defrost air position.



Face-Level

Selecting the "Face" mode will cause air to be discharged through the face level vents.



Bi-Level

Air is discharged through the face vents and the

1-44

floor vents. This makes it possible to have cooler air from the dashboard vents and warmer air from the floor outlets at the same time.

Floor-Level

Air is discharged through the floor vents.

Floor-Defrost Level

Air is discharged through the windshield defrost vents and the floor vents.

If the "Floor-Defrost" mode is selected, the A/C will be on automatically. (If installed)

Defrost-Level

Air is discharged through the windshield defrost vents.

If the "Defrost" mode is selected, the A/C will be on automatically. (If installed)

B670E02A-AAT

TEMPERATURE CONTROL

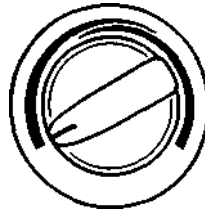

This is used to turn the heating system on and off and to select the degree of heating desired.

B690A03A-GAT

HEATING CONTROLS

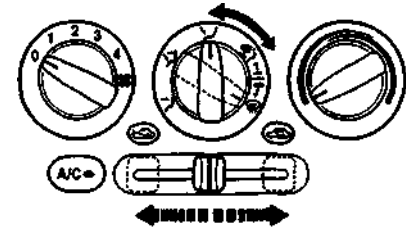

For normal heating operation, set the air intake control to the fresh air (£Eb) position and the air flow control to the floor (V') position.

For faster heating, the air intake control should be set in the recirculate (cSb) position.

If the windows fog up, set the air flow control to the defrost (Cffi) position (The A/C will be on automatically, if installed.) and the air intake control to the fresh air (£Eb) position.

For maximum heat, move the temperature control to "Warm".

FEATURES OF YOUR HYUNDAI

B670B01A-AAT

BI-LEVEL HEATING

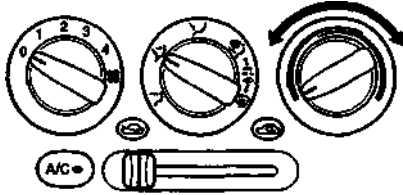

Your Hyundai is equipped with bi-level heating controls. This makes it possible to have cooler air from the dashboard vents and warmer air from the floor outlets at the same time. To use this feature:

- o Set the air intake control to the fresh air (£0\$ position).
- o Set the air flow control at the bi-level (ty) position.
- o Set the temperature control between "Cool" and "Warm".

B710A01A-AAT

VENTILATION

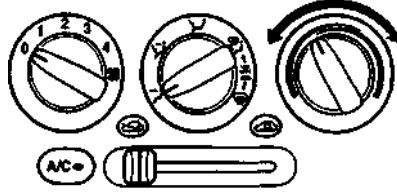

To operate the ventilation system:

- o Set the air intake control at the fresh air position.
- o To direct all intake air to the dashboard vents, set the airflow control to the face position.
- o Adjust the fan speed control to the desired speed.
- o Set the temperature control between "Cool" and "Warm".

B710B01A-AAT

CENTER VENTILATOR

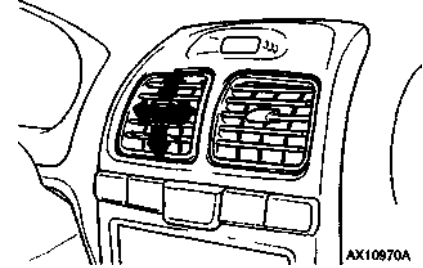

The center ventilators are located in the middle of the dashboard.

To change the direction of the airflow, turn the control knob on the middle of the ventilator as desired.

B710C01A-AAT

SIDE VENTILATOR

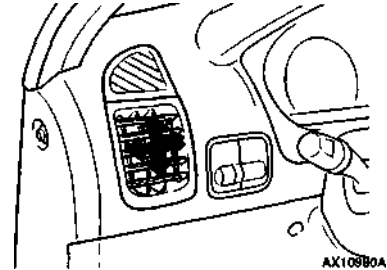

FEATURES OF YOUR HYUNDAI

The side ventilators are located on each side of the dashboard. To change the direction of the air flow, turn the control knob on the middle of the side ventilator as desired.

B720A03A-QAT

DEFROSTING/DEFOGGING

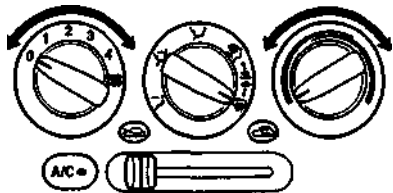

Use the heating/ventilation system to defrost or defog the windshield:

To remove the interior fog on the windshield:

- o Set the air intake control to the fresh air (FRESH) position.
- o Set the air flow control to the defrost (DEFROST) position. (The A/C will be on automatically, if installed.)
- o Set the temperature control at the desired position.
- o Set the fan speed control between "1" and "4" position.

To remove the frost or exterior fog on the windshield:

- o Set the air intake control to the fresh (FRESH) position.
- o Set the air flow control to the defrost (DEFROST) position. (The A/C will be on automatically, if installed.)
- o Set the temperature control to the warm.
- o Set the fan speed control to position "3" or "4".

B730A01A-AAT

OPERATION TIPS

- o To keep dust or unpleasant fumes from entering the car through the ventilation system, temporarily set the air intake control at the FRESH position. Be sure to return the control to the DEFROST position when the irritation has passed to keep fresh air in the vehicle. This will help keep the driver alert and comfortable.
- o Air for the heating/cooling system is drawn in through the grilles just ahead of the windshield. Care should be taken that these are not blocked by leaves, snow, ice or other obstructions.

B740A01A-AAT

AIR CONDITIONING SWITCH

(If Installed)

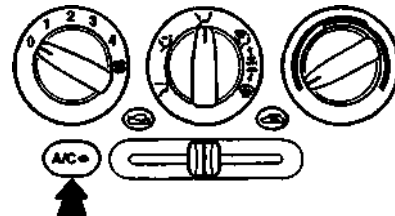

The air conditioning is turned on by pushing the A/C button on the heating/air conditioning control panel.

FEATURES OF YOUR HYUNDAI

B740B02A-AAT

AIR CONDITIONING OPERATION

(If Installed)

Cooling

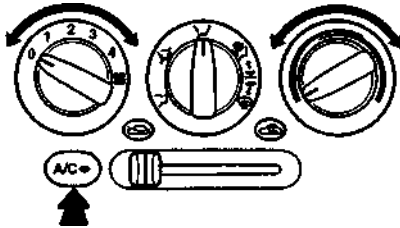

To use the air conditioning to cool the interior:

- o Turn on the fan control switch.
- o Turn on the air conditioning switch by pushing in on the switch. The air conditioning indicator light should come on at the same time.
- o Set the air intake control to the £2> position.
- o Set the temperature control to "Cool". ("Cool" provides maximum cooling. The temperature may be moderated by moving the control toward "Warm".)
- o Adjust the fan control to the desired speed. For greater cooling, turn the fan control to one of the higher speeds or temporarily select the dSb position on the air intake control.

B740C01A-AAT

De-Humidified Heating

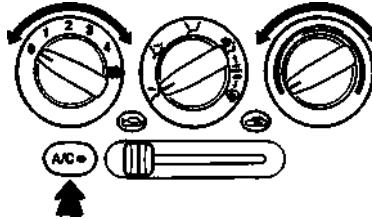

For dehumidified heating:

- o Turn on the fan control switch.
- o Turn on the air conditioning switch. The air conditioning indicator light should come on at the same time.
- o Set the air intake control to the fresh air (£2>) position.
- o Set the air flow control to the face ("^J) position.
- o Adjust the fan control to the desired speed.
- o For more rapid action, set the fan at one of the higher speeds.
- o Adjust the temperature control to provide the desired amount of warmth.

B740001A-AAT

Operation Tips

- o If the interior of the car is hot when you first get in, open the windows for a few minutes to expel the hot air.
- o When you are using the air conditioning system, keep all windows closed to keep hot air out.
- o When moving slowly, as in heavy traffic, shift to a lower gear. This increases engine speed, which in turn increases the speed of the air conditioning compressor.
- o On steep grades, turn the air conditioner off to avoid the possibility of the engine over-

During winter months or in periods when the air conditioner is not used regularly, run the air conditioner once every month for a few minutes. This will help circulate the lubricants and keep your system in peak operating condition.

FEATURES OF YOUR HYUNDAI

B760A04Y-GAT

AIR FILTER (FOR EVAPORATOR AND BLOWER UNIT) (If installed)

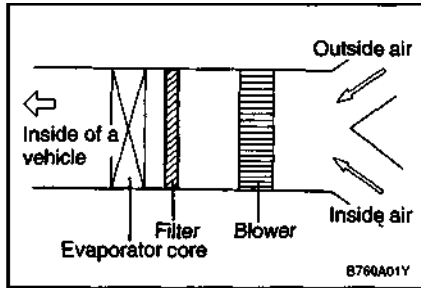

The airfilter is located in the evaporator behind the glove box. It operates to prevent pollutant enter the car and to purify the air.

CAUTION:

- o Replace the filter every 20,000km (12,000 miles) or once a year. If the car is being driven in severe conditions such as dusty, rough roads, more frequent air filter inspections and changes are required.
- o When the air flow rate is suddenly decreased, it must be checked at authorized dealer.

B750A01A-AAT

STEREO SOUND SYSTEM

How Car Audio Works

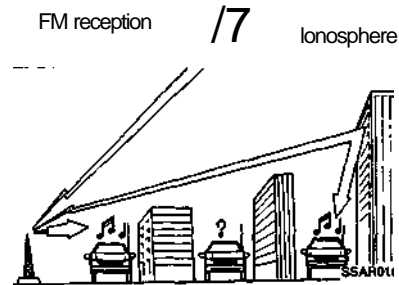

AM and FM radio signals are broadcast from transmitter towers located around your city. They are intercepted by the radio antenna on your car. This signal is then received by the radio and sent to your car speakers. When a strong radio signal has reached your vehicle, the precise engineering of your audio system ensures high quality reproduction. However, in some cases the signal coming to your vehicle is not strong and clear. This can be due to factors such as the distance from the radio station, closeness of other strong radio stations or the presence of buildings, bridges or other large obstructions in the area.

AM reception

lonosphere



AM signal reception is usually better than FM reception. This is because AM radio waves are transmitted at low frequency. These long, low frequency radio waves can follow the curvature of the earth rather than travelling straight out into the atmosphere. In addition, they curve around obstructions so that they can provide better signal coverage. Because of this, clear AM broadcasts can be received at greater distances than FM broadcasts.

FEATURES OF YOUR HYUNDAI

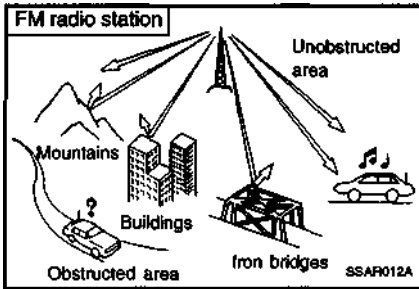

FM broadcasts are transmitted at high frequency and do not bend to follow the earth's surface. Because of this, FM broadcasts generally begin to fade at short distances from the station. Also, FM signals are easily affected by buildings, mountains, or other obstructions. These can result in certain listening conditions which might lead you to believe a problem exists with your radio. The following conditions are normal and do not indicate radio trouble:

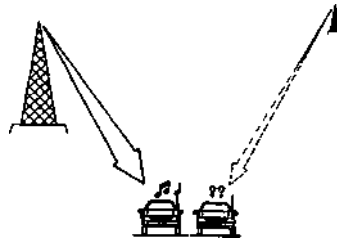

Fading - As your car moves away from the radio station, the signal will weaken and sound will begin to fade. When this occurs, we suggest that you select another stronger station.

Flutter/Static - Weak FM signals or large obstructions between the transmitter and your radio can disturb the signal causing static or fluttering noises to occur. Reducing the treble level may lessen this effect until the disturbance clears.

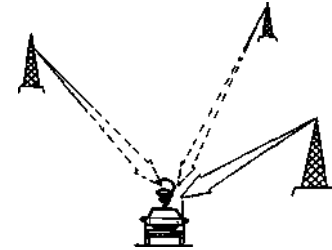

Station Swapping - As an FM signal weakens, another more powerful signal near the same frequency may begin to play. This is because your radio is designed to lock onto the clearest signal. If this occurs, select another station with a stronger signal.

Multi-Path Cancellation - Radio signals being received from several directions can cause distortion or fluttering. This can be caused by a direct and a reflected signal from the same station, or by signals from two stations with close frequencies. If this occurs, select another station until the condition has passed.

FEATURES OF YOUR HYUNDAI

B750B01Y-AAT

Using a cellular phone or a two-way radio

When a cellular phone is used inside the vehicle, noise may be produced from the audio equipment. This does not mean that something is wrong with the audio equipment. In such a case, use the cellular phone at a place as far as possible from the audio equipment.

CAUTION:

When using a communication system such as a cellular phone or a radio set inside the vehicle, a separate external antenna must be fitted. When a cellular phone or a radio set is used by using an internal antenna alone, it may interfere with the vehicle's electrical system and adversely affect safe operation of the vehicle.

FEATURES OF YOUR HYUNDAI

H900601A-GAT

STEREO RADIO OPERATION (H900B)

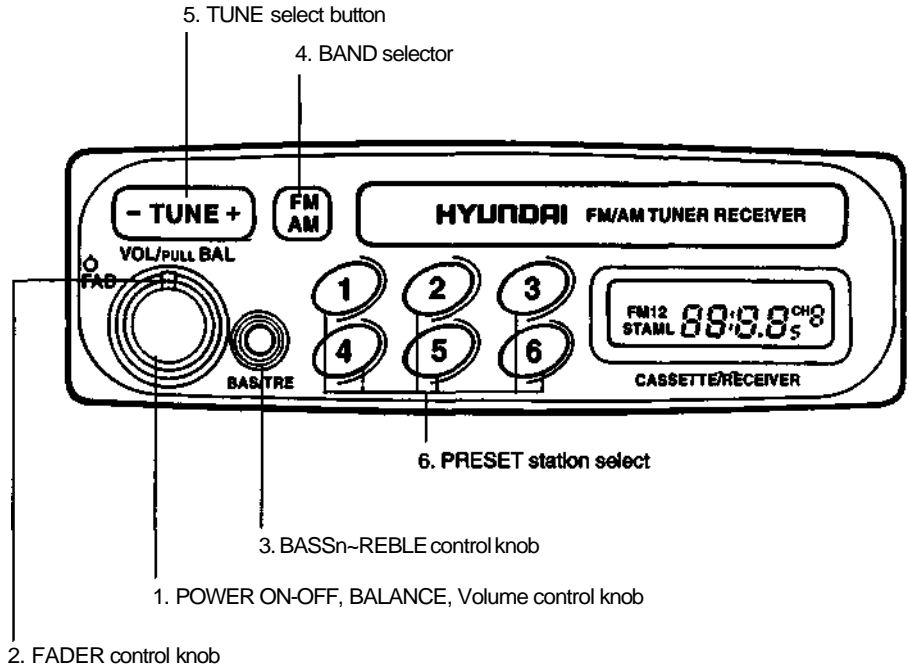

FEATURES OF YOUR HYUNDAI

H900B01B-QAT

1. POWER ON-OFF/VOLUME CONTROL KNOB

The radio unit may be operated when the ignition key is in the "ACC" or "ON" position. Rotate the knob clockwise to switch the radio unit on and to increase the volume.

The LCD shows the radio frequency in the radio mode. Turn the knob counterclockwise to reduce the volume and to switch the radio unit off.

BAL (Balance Control) Knob

Pull and turn the control knob clockwise to emphasize right speaker sound. (Left speaker sound will be attenuated) When the control knob is turned counterclockwise, left speaker sound will be emphasized. (Right speaker sound will be attenuated)

2. FAD (Fader Control) Knob

Turn the control knob clockwise to emphasize front speaker sound (Rear speaker sound will be attenuated). When the control knob is turned counterclockwise, rear speaker sound will be emphasized (Front speaker sound will be attenuated).

3. BASS Control Knob

Press to pop the knob out and turn to the left or right for the desired bass tone.

TREBLE Control Knob.

Further pull-lock position of popped-up knob. Turn to the left or right for the desired treble tone.

4. BAND Selector

Pressing the ^ button changes the AM, FM1 and FM2 bands. The mode selected is displayed on LCD.

5. TUNE (manual) Select Button

Press the (+) side or (-) side to increase or to decrease the frequency. With the button held down for 0.5 sec. or more, the stop signal (broadcasting radio wave) is ignored and channel selection continues.

SEEK Operation (Automatic Channel Selection)

Press the TUNE select button 1 sec. or more. When the (+) side is pressed, the unit will automatically tune to the next higher frequency and when the (-) side is pressed, it will automatically tune to the next lower frequency.

6. PRESET STATION SELECT Button

Six (6) stations for AM, FM and FM2 respectively can be preset in the electronic memory circuit on this unit.

HOW TO PRESET STATIONS

Six AM and twelve FM stations may be programmed into the memory of the radio. Then, by simply pressing the band select button and/or one of the six station select buttons, you may recall any of these stations instantly. To program the stations, follow these steps:

- o Press band selector to set the band for AM, FM, and FM2.
- o Select the desired station to be stored by seek, scan or manual tuning.
- o Determine the preset station select button you wish to use to access that station.
- o Press the station select button for more than two seconds. A select button indicator will show in the display indicating which select button you have depressed. The frequency display will flash after it has been stored into the memory. You should then release the button, and proceed to program the next desired station. A total of 18 stations can be programmed by selecting one AM and two FM stations per button.
- o When completed, any preset station may be recalled by selecting AM, FM or FM2 band and the appropriate station button.

FEATURES OF YOUR HYUNDAI

H900A01A-GAT

STEREO RADIO AND CASSETTE TAPE PLAYER OPERATION (H900A) (If installed)

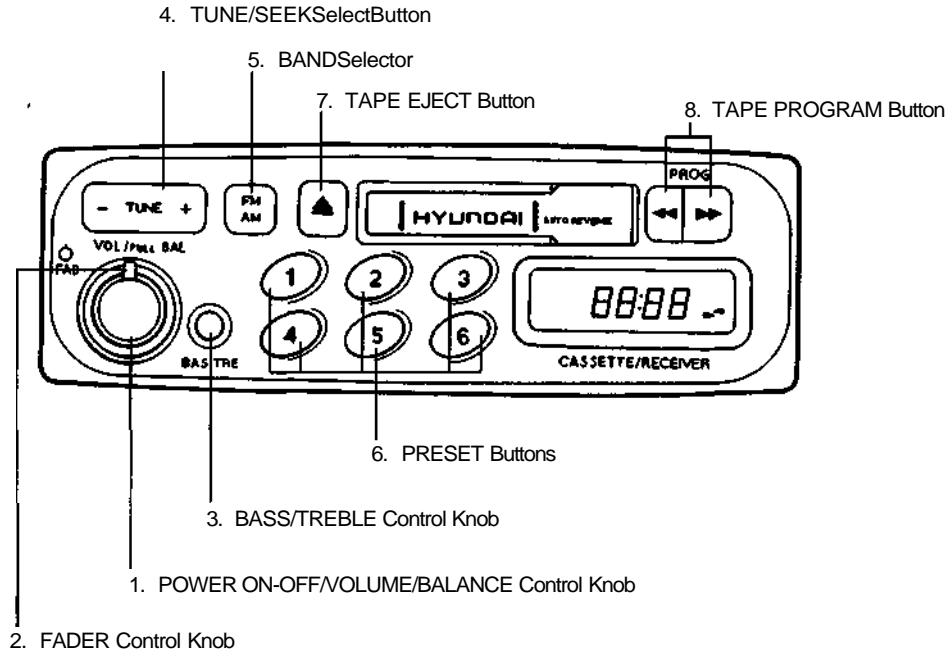

FEATURES OF YOUR HYUNDAI

H900A01B-GAT

1. POWER ON-OFF/VOLUME CONTROL KNOB

The radio unit may be operated when the ignition key is in the "ACC" or "ON" position. Rotate the knob clockwise to switch the radio unit on and to increase the volume. The LCD shows the radio frequency in the radio mode, or the tape direction indicator in the tape mode. Turn the knob counterclockwise to reduce the volume and to switch the radio unit off.

BAL (Balance Control) Knob

Pull and turn the control knob clockwise to emphasize right speaker sound. (Left speaker sound will be attenuated) When the control knob is turned counterclockwise, left speaker sound will be emphasized. (Right speaker sound will be attenuated)

2. FAD (Fader Control) Knob

Turn the control knob clockwise to emphasize front speaker sound (Rear speaker sound will be attenuated). When the control knob is turned counterclockwise, rear speaker sound will be emphasized (Front speaker sound will be atten-

3. BASS Control Knob

Press to pop the knob out and turn to the left or right for the desired bass tone.

TREBLE Control Knob

Further pult-lock position of popped-up knob. Turn to the left or right for the desired treble tone.

4. TUNE (Manual) Select Button

Press the (+) side or (-) side to increase or to decrease the frequency. With the button held down for 0.5 sec. or more, the stop signal (broadcasting radio wave) is ignored and channel selection continues.

SEEK Operation (Automatic Channel Selection)

Press the TUNE select button 1 sec. or more. When the (+) side is pressed, the unit will automatically tune to the next higher frequency and when the (-) side is pressed, it will automatically tune to the next lower frequency.

5. BAND Selector

Pressing the ^ button changes the AM, FM1 and FM2 bands. The mode selected is displayed on LCD.

6. PRESET STATION SELECT Button

Six (6) stations for AM, FM and FM2 respectively can be preset in the electronic memory circuit on this unit.

HOW TO PRESET STATIONS

Six AM and twelve FM stations may be programmed into the memory of the radio. Then,

by simply pressing the band select button and/or one of the six station select buttons, you may recall any of these stations instantly. To program the stations, follow these steps:

- o Press band selector to set the band for AM, FM, and FM2.
- o Select the desired station to be stored by seek, scan or manual tuning.
- o Determine the preset station select button you wish to use to access that station.
- o Press the station select button for more than two seconds. A select button indicator will show in the display indicating which select button you have depressed. The frequency display will flash after it has been stored into the memory. You should then release the button, and proceed to program the next desired station. A total of 18 stations can be programmed by selecting one AM and two FM stations per button.
- o When completed, any preset station may be recalled by selecting AM, FM or FM2 band and the appropriate station button.

7. TAPE EJECT Button

To eject the tape, press the button.

8. TAPE PROGRAM

When you press the button whose arrow is in the same direction as the tape play arrow in the display the tape will advance at high speed. When you press the button whose arrow is in

FEATURES OF YOUR HYUNDAI

the opposite direction to the tape play arrow in the display the tape will rewind at high speed. To stop FF or REW action, press the opposite button. When you press two buttons simultaneously you play the reverse side of the tape and an arrow will appear in the display to show tape direction.

FEATURES OF YOUR HYUNDAI

H920C01A-QAT

STEREO RADIO OPERATION (H920C) (If installed)

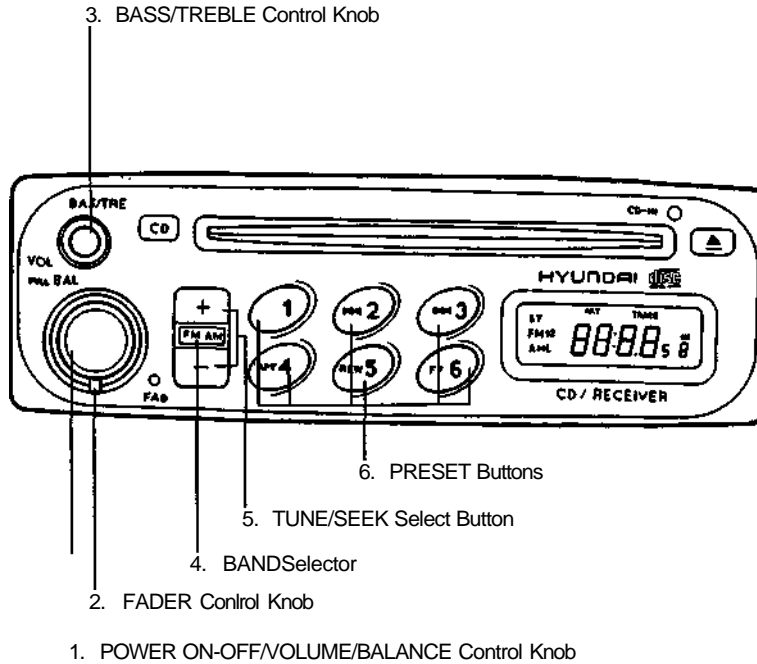

FEATURES OF YOUR HYUNDAI

H920C01B-GAT

1. POWER ON-OFF/VOLUME CONTROL KNOB

The radio unit may be operated when the ignition key is in the "ACC" or "ON" position. The clock will be displayed automatically, although the radio unit has gone out. Press the button to switch the power on. The LCD shows the radio frequency in the radio mode or the CD track indicator in the CD mode. To switch the power off, press the button again.

VOLUME Control

Rotate the knob clockwise to increase the volume and turn the knob counterclockwise to reduce the volume.

BALANCE Control

Pull and turn the control knob clockwise to emphasize right speaker sound. (Left speaker sound will be attenuated) When the control knob is turned counterclockwise, left speaker sound will be emphasized. (Right speaker sound will be attenuated)

2. FAD (Fader Control) Knob

Turn the control knob counterclockwise to emphasize front speaker sound. (Rear speaker sound will be attenuated) When the control knob is turned clockwise, rear speaker sound will be emphasized. (Front speaker sound will be attenuated)

3. BASS/TREBLE Control Knob

BASS Control Knob

Press to pop the knob out and turn to the left or right for the desired bass tone.

TREBLE Control Knob

Further pull-lock position of popped-up knob. Turn to the left or right for the desired treble tone.

4. BANO Selector

Pressing the E button changes the AM, FM1 and FM2 bands. The mode selected is displayed on LCD.

5. TUNE (Manual) Select Button

Press the (+) side or (-) side to increase or to decrease the frequency. With the button held down for 0.5 sec. or more, the stop signal (broadcasting radio wave) is ignored and channel selection continues.

SEEK Operation (Automatic Channel Selection)

Press the TUNE select button 1 sec or more, and releasing will automatically tune the next available station.

When the (+) side is pressed longer than 1 second and releasing will automatically tune the next higher frequency and when the (-) side is pressed longer than 1 second and releasing will automatically tune the next lower frequency.

6. PRESET STATION SELECT Button

Six (6) stations for AM, FM and FM2 respectively can be preset in the electronic memory circuit on this unit.

HOW TO PRESET STATIONS

Six AM and twelve FM stations may be programmed into the memory of the radio. Then, by simply pressing the band select button and/or one of the six station select buttons, you may recall any of these stations instantly. To program the stations, follow these steps:

- o Press band selector to set the band for AM, FM, and FM2.
- o Select the desired station to be stored by seek, scan or manual tuning.
- o Determine the preset station select button you wish to use to access that station.
- o Press the station select button for more than two seconds. A select button indicator will show in the display indicating which select button you have depressed. The frequency display will flash after it has been stored into the memory. You should then release the button, and proceed to program the next desired station. A total of 18 stations can be programmed by selecting one AM and two FM stations per button.
- o When completed, any preset station may be recalled by selecting AM, FM or FM2 band and the appropriate station button.

FEATURES OF YOUR HYUNDAI

H920C01C-GAT

COMPACT DISK PLAYER OPERATION (H920C) (If Installed)

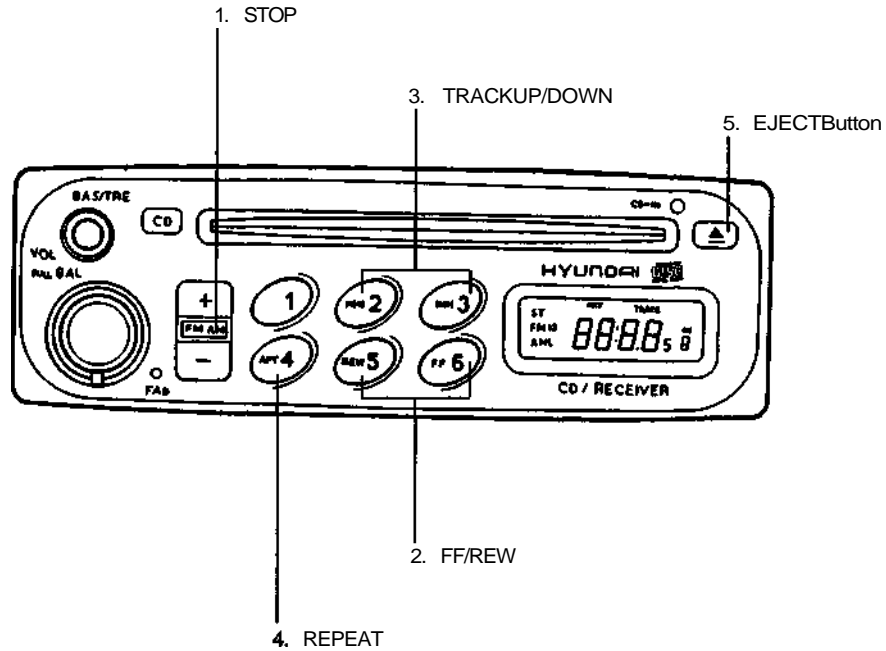

FEATURES OF YOUR HYUNDAI

H920C01D-GAT

1. STOP

- o Insert the CD to start CD playback, during the radio operation.
- o Press the **ESSf** button to stop CD playback and to change the source to Radio.

2. FF/REW

While the disc is playing, press and hold FF button to quickly move forward until you reach the desired section of the track and vice versa.

3. TRACK UP/DOWN

- o The desired track on the disc currently being played can be selected using the track number.
- o Pressing the ***<** button once increases the track number by one and pressing the **»*** button decreases it.

4. REPEAT

To repeat the music you are listening to, press the **RPT** button and to cancel music repeat, press again.

5. EJECT Button

When the **EJECT** button is pressed with the CD loaded, the CD is ejected.

NOTE:

- o To assure proper operation of the unit, keep the vehicle Interior temperature within a normal range by using the vehicle's air conditioning or heating system.
- o When replacing the fuse, replace it with a fuse having the correct capacity.
- o The preset station frequencies are all erased when the car battery is disconnected. Therefore, all data will have to be set again if this should occur.
- o Do not add any oil to the rotating parts.
- o This equipment is designed to be used only in a 12 volt DC battery system with negative ground.
- o This unit is made of precision parts. Do not attempt to disassemble or adjust any parts.
- o When driving your vehicle, be sure to keep the volume of the unit set low enough to allow you to hear sounds coming from the outside.
- o Do not expose this equipment (including the speakers and tape) to water or excessive moisture.

FEATURES OF YOUR HYUNDAI

B850A01F-AAT

CARE OF DISC Proper Handling

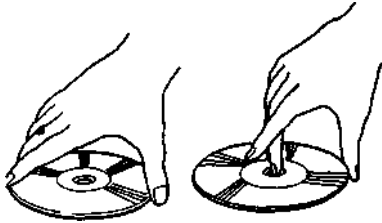

Handle your disc as shown. Do not drop the disc. Hold the disc so you will not leave fingerprints on the surface. If the surface is scratched, it may cause the pickup to skip signal tracks. Do not affix tape, paper, or gummed labels on the disc. Do not write on the disc.

Damaged Disc

Do not attempt to play damaged, warped or cracked discs. These could severely damage the playback mechanism.

Storage

When not in use, place your discs in their individual cases and store them in a cool place away from the sun, heat, and dust. Do not grip or pull out the disc with your hand

while the disc is being pulled into the unit by the self loading mechanism.

Do not pull the unit from the dash immediately after a disc is inserted or the eject switch has been pressed. If the unit is pulled out before an operation is completed, the disc will be unstable in the unit and may be damaged.

Do not attempt to insert a disc into the unit when the unit is out of the dash or the power is off.

Keep Your Discs Clean

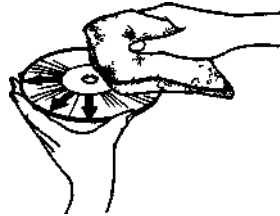

Fingerprints, dust, or soil on the surface of a disc could cause the pickup to skip signal tracks. Wipe the surface clean with a clean soft cloth. If the surface is heavily soiled, dampen a clean soft cloth in a solution of mild neutral detergent to wipe it clean. See drawing.

AB540C1 A

Care of Cassette Tapes

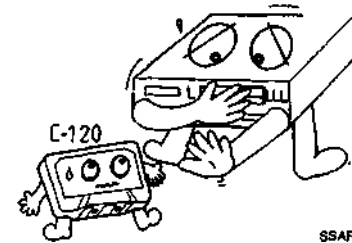

Proper care of your cassette tapes will extend the tape life and increase your listening enjoyment. Always protect your tapes and cassette cases from direct sunlight, severe cold and dusty conditions. When not in use, cassettes should always be stored in the protective cassette case in which they were originally supplied. When the vehicle is very hot or cold, allow the interior temperature to become more comfortable before listening to your cassettes.

- o Never leave a cassette inserted in the player when not being played. This could damage the tape player unit and the cassette tape.
- o We strongly recommend against the use of tapes longer than C-60 (60 minutes total). Tapes such as C-120 or C-180 are very thin and do not perform as well in the automotive environment.

FEATURES OF YOUR HYUNDAI

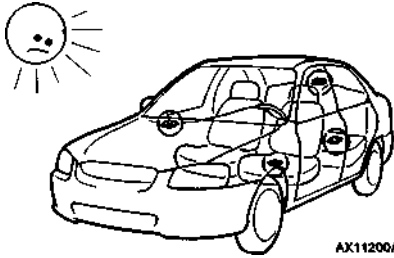

Be sure that the cassette label is not loose or peeling off or tape ejection may be difficult.

Never touch or soil the actual audio tape surfaces.

Keep all magnetized objects, such as electric motors, speakers or transformers away from your cassette tapes and tape player unit.

Store cassettes in a cool, dry place with the open side facing down to prevent dust from settling in the cassette body.

Avoid repeated fast reverse usage to replay one given tune or tape section. This can cause poor tape winding to occur, and eventually cause excessive internal drag and poor audio quality in the cassette. If this occurs, it can sometimes be corrected by fast winding the tape from end to end several times. If this does not correct the problem, do not continue to use the tape in your vehicle.

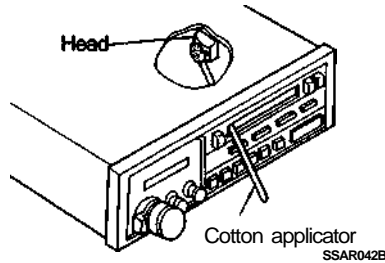

The playback head, capstan and pinch rollers will develop a coating of tape residue that can result in deterioration of sound quality, such as a wavering sound. They should be cleaned monthly using a commercially available head cleaning tape or special solution available from audio specialty shops. Follow the supplier's directions carefully and never oil any part of the tape player unit.

Always be sure that the tape is tightly wound on its reels before inserting in the player. Rotate a pencil in the drive sprockets to wind up any slack.

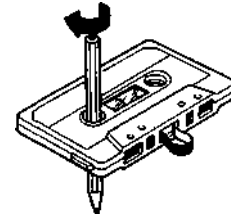

NOTE:

Look at a tape before you insert it.

If the tape is loose, tighten it by turning one of the hubs with a pencil or your finger. If the label is peeling off, do not put it in the player. It may cause the tape to Jam in the drive mechanism when you try to eject it.

Do not leave tape sitting where they are exposed to high temperature or, high humidity, such as on top of the dashboard or in the player.

If a tape is exposed to extreme heat or cold, let it reach a moderate temperature before putting it in the player.

FEATURES OF YOUR HYUNDAI

B870A01A-QAT ANTENNA

Fixed Rod Antenna (If installed)

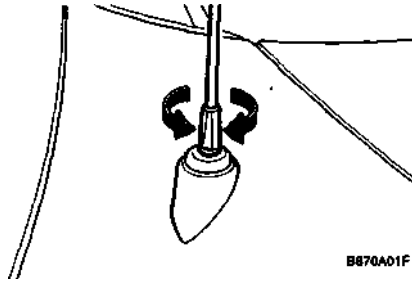

Your car uses a fixed rod antenna to receive both AM and FM broadcast signals. This antenna is a removable type. To remove the antenna, turn the antenna counterclockwise. To install the antenna, turn the antenna clockwise.

CAUTION:

Be sure to remove the antenna before washing the car. In an automatic car wash or the antenna may be damaged.

B870C01A-QAT Manual Antenna

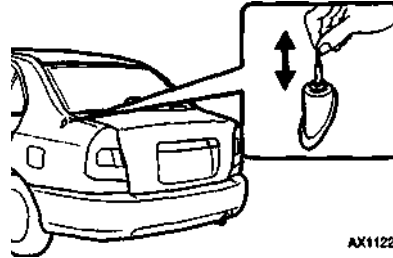

Your car uses a manual stainless steel antenna to receive both AM and FM broadcast signals. Pull up the antenna using your fingers, as shown in the drawing.

NOTE:

Before entering an automatic car wash or a place with a low height clearance, be sure that the antenna is fully retracted.

B870B01Y-AAT Power Antenna (If installed)

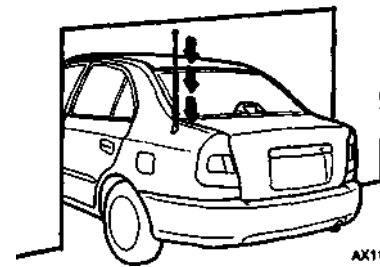

The antenna will automatically be extended when the radio power switch is turned on while the ignition key is in either the "ON" or "ACC" position. The antenna will automatically be retracted and stored when either the radio power switch is turned off or the ignition key is set to the "LOCK" position.

NOTE:

- o Before turning on the radio, make sure that no one is near the antenna.
- o Before entering an automatic car wash or a place with a low height clearance, be sure that the antenna is retracted and stored.
- o If the antenna is dirty, be sure to clean it in order to avoid an operation malfunction.

DRIVING YOUR HYUNDAI

2. BEHINDTHE WHEEL - Driving Your Hyundai

WARNING: ENGINE EXHAUST CAN BE DANGEROUS!

Engine exhaust fumes can be extremely dangerous. If, at any time, you smell exhaust fumes inside the vehicle, open the windows immediately.

o Do not Inhale exhaust fumes.

Exhaust fumes contain carbon monoxide, a colorless, odorless gas that can cause unconsciousness and death by asphyxiation.

o Be sure the exhaust system does not leak.

The exhaust system should be checked whenever the vehicle is raised to change the oil or for any other purpose. If you hear a change in the sound of the exhaust or if you drive over something that strikes the underneath side of the car, have the exhaust system checked as soon as possible by your Hyundai dealer.

o Do not run the engine in an enclosed area.

Letting the engine idle in your garage, even with the garage door open, is a hazardous practice. Never run the engine in your garage any longer than it takes to start the engine and back the car out.

o Avoid idling the engine for prolonged periods with people inside the car.

If it is necessary to idle the engine for a prolonged period with people inside the car, be sure to do so only in an open area with the air intake set at "Fresh" and the fan operating at one of the higher speeds so fresh air is drawn into the interior.

If you must drive with the hatchback/trunk open because you are carrying objects that make this necessary:

1. Close all windows.
2. Open side vents.
3. Set the air intake control at "Fresh", the air flow control at "Floor" or "Face" and the fan at one of the higher speeds.

To assure proper operation of the ventilation system, be sure the ventilation air intakes located just in front of the windshield are kept clear of snow, ice, leaves or other obstructions.

DRIVING YOUR HYUNDAI

C020A01A-AAT

BEFORE STARTING THE ENGINE

Before you start the engine, you should always:

1. Look around the vehicle to be sure there are no flat tires, puddles of oil, water or other indications of possible trouble.
2. After entering the car, check to be sure the parking brake is engaged.
3. Check that all windows, and lights are clean.
4. Check that the interior and exterior mirrors are clean and in position.
5. Check your seat, seatback and headrest to be sure they are in their proper positions.
6. Lock all the doors.
7. Fasten your seat belt and be sure that all other occupants have fastened theirs.
8. Turn off all lights and accessories that are not needed.
9. When you turn the ignition switch to "ON", check that all appropriate warning lights are operating and that you have sufficient fuel.
10. Check the operation of warning lights and all bulbs when key is in the "ON" position.

C030A01A-GAT

COMBINATION IGNITION SWITCH

To Start the Engine

- o If your Hyundai is equipped with a manual transaxle, place the shift lever in neutral and depress the clutch pedal fully.
- o If your Hyundai has an automatic transaxle, place the shift lever in "P" (park).
- o To start the engine, insert the ignition key and turn it to the "START" position. Release it as soon as the engine starts. Do not hold the key in the "START" position for more than 15seconds.

NOTE:

For safety, the engine will not start if the shift lever is not in "P" or "N" Position (Auto T/A).

C040A01A-AAT

KEY POSITIONS

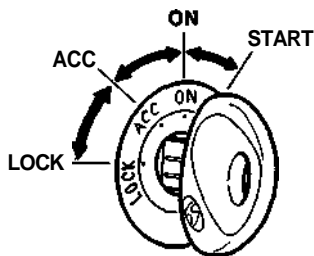

WARNING:

The engine should not be turned off or the key removed from the ignition key cylinder while the vehicle is in motion. The steering wheel is locked by removing the key.

o "START"

The engine is started in this position. It will crank until you release the key.

NOTE:

Do not hold the key in the "START" position for more than 15 seconds.

o "ON"

When the key is in the "ON" position, the ignition is on and all accessories may be turned on. If the engine is not running, the key should not be left in the "ON" position. This will discharge the battery and may also damage the ignition system.

o "ACC"

With the key in the "ACC" position, some electrical accessories (radio etc.) may be operated.

o "LOCK"

The key can be removed or inserted in this position. To protect against theft, the steering wheel locks by removing the key.

DRIVING YOUR HYUNDAI

NOTE:

To unlock the steering wheel, insert the key, and then turn the steering wheel and key simultaneously.

C060A01A-QAT

STARTING (For Carburetor)

Normal Starting Procedure

1. If your car has manual transaxle, place the shift lever in neutral and depress the clutch. If your car has automatic transaxle, place the shift lever in "P".
2. Turn the key to "START". Release the key as soon as the engine starts. If the engine does not start immediately, do not operate the starter for more than 15 seconds at a time. Try again after waiting a few seconds.

C060B01A-GAT

If the Engine is Cold

COLD ENGINE

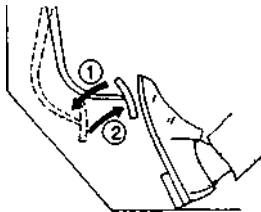

DEPRESS 1 AND RELEASE 2 ssA200cc

1. Press the accelerator pedal all the way to the floor, then release it.
2. Turn the key to the "START". Release the key as soon as the engine starts.

WARNING:

Do not start the engine with the transaxle engaged in gear.

CAUTION:

Do not leave the car unattended during this warm-up period.

If the car is in a garage, be sure that the garage door is open. Letting the engine door open, is a hazardous practice. Never run the engine in your garage any longer than it takes to start the engine and back the car out.

C060C01A-GAT

Warm Engine

WARM ENGINE

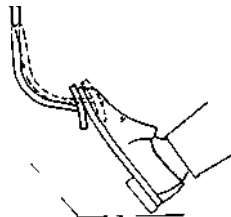

DEPRESS 1/2 DOWN ssA2080D

- o Depress and hold the accelerator pedal about half of the way down while cranking.

NOTE:

If the engine is hard to start at high ambient temperatures, hold the accelerator pedal on the floor during cranking.

- o Turn the ignition key to the "START" position, and then release the key and the pedal when the engine starts.

C060D01A-GAT

Flooded Engine

FLOODED ENGINE

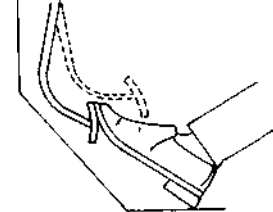

DEPRESS FULLY ssA2080E

Depress the accelerator pedal fully and hold it to the floor until the engine starts. Never "pump" the accelerator pedal.

DRIVING YOUR HYUNDAI

NOTE:

When it is necessary to warm up the engine for an extended period, make sure there is no wastepaper or any other combustible matter near the end of the exhaust pipe.

C060E01A-QAT

If the Engine Stalls

If the engine stalls or dies after being started, repeat the appropriate starting procedure as directed above depending on whether the engine is cold, warm or hot.

C050A01A-AAT

STARTING

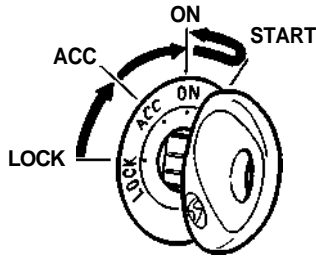

WARNING:

Never run the engine in a closed or poorly ventilated area any longer than is needed to move your car in or out of the area. The

carbon monoxide gas emitted is odorless and can cause serious injury or death.

C050B01A-QAT

Normal Conditions:

The Starting Procedure:

1. Insert key, and fasten the seat belt.
2. Depress the clutch pedal fully and place the gearshift lever (manual transaxle) in neutral or the selector lever (automatic transaxle) in "P" (park) position.
3. After turning the ignition key to the "ON" position, make certain all warning lights and gauges are functioning properly before starting the engine.

WARNING:

Be sure that the clutch is fully depressed when starting a manual transaxle vehicle. Otherwise, there is the potential to cause damage to the vehicle or injury to someone inside or outside the vehicle as a result of the forward or backward movement of the vehicle that will occur if the clutch is not depressed when the vehicle is started.

4. Turn the ignition key to the "Start" position and release it when the engine starts.

C070A01A-AAT

OPERATING THE MANUAL TRANSAXLE

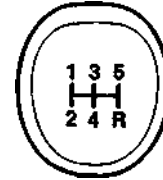

Your Hyundai's manual transaxle has a conventional shift pattern.

This shift pattern is also imprinted on the shift knob. The transaxle is fully synchronized in all forward gears so shifting to either a higher or a lower gear is easily accomplished.

NOTE:

To shift into reverse, rest the lever in neutral for at least 3 seconds after your car is completely stopped. Then move the lever into the reverse position.

CAUTION:

When downshifting from fifth gear to fourth gear, caution should be taken not to inadvertently press the gear shift lever sideways in such a manner that second gear is engaged. Such a drastic downshift may cause

the engine speed to increase to the point that the tachometer will enter the red zone. Such over rewing of the engine may possibly cause engine damage.

C070B01A-AAT

Using the Clutch

The clutch should be pressed all the way to the floor before shifting, then released slowly. The clutch pedal should always be used after fully returning to the original position. Do not rest your foot on the clutch pedal while driving. This can cause unnecessary wear. Do not partially engage the clutch to hold the car on an incline. This causes unnecessary wear. Use the parking brake to hold the car on an incline. Do not operate the clutch pedal rapidly and repeatedly.

C070002A-AAT

Good Driving Practices

- o Never take the car out of gear and coast down a hill. This is extremely hazardous. Always leave the car in gear.
- o Don't "ride" the brakes. This can cause them to overheat and malfunction. Instead, when you are driving down a long hill, slow down and shift to a lower gear. When you do this, engine braking will help slow the car.
- o Slow down before shifting to a lower gear. This will help avoid over-rewinding the engine, which can cause damage.

DRIVING YOUR HYUNDAI

- o Slow down when you encounter crosswinds. This gives you much better control of your car.
- o Be sure the car is completely stopped before you attempt to shift into reverse. The transaxle can be damaged if you do not. To shift into reverse, depress the clutch, move the shift lever to neutral, wait three seconds, then shift to the reverse position.
- o Exercise extreme caution when driving on a slippery surface. Be especially careful when braking, accelerating or shifting gears. On a slippery surface, an abrupt change in vehicle speed can cause the drive wheels to lose traction and the vehicle to go out of control.

CAUTION:

- o **The risk of rollover is greatly increased if you lose control of your vehicle at high speeds.**
- o **Loss of control often occurs if two or more wheels drop off the roadway and the driver oversteers to reenter the roadway.**
- o **In the event your vehicle leaves the roadway, do not steer sharply. Instead, slow down before pulling back into the travel lanes.**

C070C01A-AAT

To Remove the Ignition Key

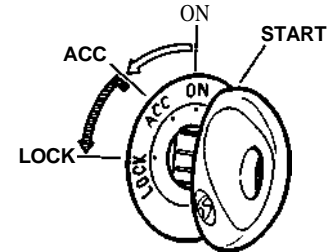

1. Turn the ignition key to the "ACC" position.
2. Simultaneously push and turn the ignition key counterclockwise from the "ACC" position to the "LOCK" position.
3. The key can be removed in the "LOCK" position.

C070E01A-GAT

Recommended Shift Speeds

The shift speeds as shown below are recommended for optimum fuel economy and performance.

DRIVING YOUR HYUNDAI

Shift from-to	Recommended
1-2 or 2-1	20km/h(15mph)
2-3 or 3-2	40 km/h (25 mph)
3-4 or 4-3	55 km/h (35 mph)
4-5 or 5-4	75 km/h (45 mph)

C090A01A-GAT

AUTOMATIC TRANSAXLE

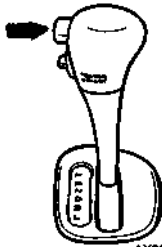
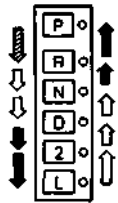

AX20080J

The highly efficient Hyundai automatic transaxle has four forward speeds and one reverse speed. It has a conventional shift pattern as shown in the illustration. At night, with the first position of the multi-function switch, the appropriate symbol on the shift pattern indicator will be illuminated according to the range selected.

CAUTION:

Never shift into "R" or "P" position while the car is moving.

NOTE:

<^> Depress the brake pedal and push the button when shifting

^ Push the button when shifting

^ The selector lever can be shifted freely.

For optimum fuel economy, accelerate gradually. The transaxle will automatically shift to the second, third and overdrive gears.

C090B01A-AAT

The function of each position is as follows:

o P (Park):

Use to hold the vehicle in place when parked or while starting the engine; shift the selector lever to the "P" position. Whenever parking the car, apply the parking brake and shift the selector lever to the "P" (Park) position.

CAUTION:

Never place the selector lever in the "P" position unless the vehicle is fully stopped. Failure to observe this caution will cause severe damage to the transaxle.

C090C01A-AAT

o R (Reverse):

Use for backing up the vehicle. Bring the car to a complete stop before shifting the selector lever to "R" position.

C090D02A-AAT

o N (Neutral):

In the "N" position, the transaxle is in neutral, which means that no gears are engaged. The engine can be started with the shift lever in "N" position, although this is not recommended except if the engine stalls while the car is moving.

C090E01A-GAT

o D (Drive):

Use for normal driving. The transaxle will automatically shift through a four-gear sequence, giving best economy and power. Never down-shift manually to '2' position or "L" position when vehicle speed is more than 95 km/h (60 mph).

C090F01A-MT

o 2 (Second gear):

Use for driving on a slippery road, hill climbing or engine braking downhill. "2" automatically shifts between 1st and 2nd gears.

This means that no shift-up to 3rd gear is performed. However, the shift-up to 3rd gear is done when the car speed exceeds a certain value to prevent the engine from over-revving. Manually move the selector to "D" returning to normal driving condition.

DRIVING YOUR HYUNDAI

C090G01A-GAT

o **L (Low gear):**

Use for driving up a very steep grade or for engine braking when descending steep hills. When downshifting to "L", the transaxle will temporarily remain in second gear until the vehicle has slowed enough for low gear to engage. Do not exceed 50 km/h.(30 mph) in low gear.

C090H01A GAT

NOTE:

- o **For smooth and safe operation, depress the brake pedal when shifting from "Neutral" position or "Park" position to a forward or reverse gear.**
- o **The brake pedal fully depressed in order to move the shift lever from the "P" (Park) position to any of the other positions.**
- o **It is always possible to shift from "R", "N", "D", "2", "L" position to "P" position.**

C090101A-AAT

CAUTION:

- o **Shift into "R" and "P" position only when the vehicle has completely stopped.**
- o **Do not accelerate the engine in reverse or any of the forward positions with the brakes applied.**

- o **Always apply the footbrake when shifting from "P" or "N", to "R", "D", "2" or "L" position.**
- o **Do not use the "P" (Park) position in place of the parking brake. Always set the parking brake, shift the transaxle into "P" (Park) position and turn off the ignition when you leave the vehicle, even momentarily. Never leave the vehicle unattended while the engine is running.**
- o **Check the automatic transaxle fluid level regularly, and add fluid as necessary.**

C090N02A-AAT

Good Driving Practices

- o Never move the gear selector lever from "P" or "N" to any other position with the accelerator pedal depressed.
- o Never move the gear selector lever into "P" when the vehicle is in motion.
- o Be sure the car is completely stopped before you attempt to shift into "R".
- o Never take the car out of gear and coast down a hill. This may be extremely hazardous. Always leave the car in gear when moving.
- o Do not "ride" the brakes. This can cause them to overheat and malfunction. Instead, when you are driving down a long hill, slow down and shift to a lower gear. When you do this, engine braking will help slow the car.
- o Slow down before shifting to a lower gear. Otherwise, the lower gear may not be en-

- o Always use the parking brake. Do not depend on placing the transaxle in "P" to keep the car from moving.
- o Exercise extreme caution when driving on a slippery surface. Be especially careful when braking, accelerating or shifting gears. On a slippery surface, an abrupt change in vehicle speed can cause the drive wheels to lose traction and the vehicle to go out of control.
- o Turn the overdrive switch on for good fuel economy and smooth driving. If engine braking is needed in the "D" range or if repeated upshifting and downshifting between the 3rd and 4th gear is needed when climbing a gentle slope, it is recommended that the overdrive switch be turned off. Turn the overdrive switch back on immediately afterward.

WARNING:

- o The risk of rollover is greatly increased if you lose control of your vehicle at high-wayspeeds.
- o Loss of control often occurs if two or more wheels drop off the roadway and the driver oversteers to reenter the roadway.
- o In the event your vehicle leaves the roadway, do not steer sharply. Instead, slow down before pulling back into the travel lanes.

C090P01A-QAT

Overdrive Switch

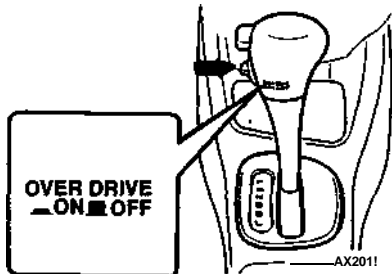

When the overdrive switch is turned on, the transaxle will automatically upshift to the second, third and overdrive gears. When the overdrive switch is turned off, the transaxle will not upshift to the overdrive gear. For normal driving, the selector lever should be left in the "D" position and the overdrive switch turned on. If you need to accelerate rapidly, press the accelerator pedal all the way to the floor. The transaxle will automatically shift to a lower gear, depending on the vehicle speed and load.

DRIVING YOUR HYUNDAI

C130A01A-AAT

GOOD BRAKING PRACTICES

WARNING:

Nothing should be carried on top of the cargo area cover behind the rear seat. If there were an accident or a sudden stop, such objects could move forward and cause damage to the vehicle or injure the occupants.

- o After being parked, check to be sure the parking brake is not engaged and that the parking brake indicator light is out before driving away.
- o Driving through water may get the brakes wet. They can also get wet when the car is washed. Wet brakes can be dangerous! Your car will not stop as quickly if the brakes are wet. Wet brakes cause the car to pull to one side. To dry the brakes, apply the brakes lightly until the braking action returns to normal, taking care to keep the car under control at all times. If the braking action does not return to normal, stop as soon as it is safe to do so and call your Hyundai dealer for assistance.
- o Don't coast down hills with the car out of gear. This is extremely hazardous. Keep the car in gear at all times, use the brakes to slow down, then shift to a lower gear so that engine braking will help you maintain a safe

speed.

- o Don't "ride" the brake pedal. Resting your foot on the brake pedal while driving can be dangerous because it can result in the brakes overheating and losing their effectiveness. It also increases the wear of the brake components.
- o If a tire goes flat while you are driving, apply the brakes gently and keep the car pointed straight ahead while you slow down. When you are moving slowly enough for it to be safe to do so, pull off the road and stop in a safe place.
- o If your car is equipped with an automatic transaxle, don't let your car creep forward. To avoid creeping forward, keep your foot on the brake pedal when the car is stopped.
- o Use caution when parking on a hill. Engage the parking brake and place the gear selector lever in "P" (automatic transaxle) or in first or reverse gear (manual transaxle). If your car is facing downhill, turn the front wheels into the curb to help keep the car from rolling. If your car is facing uphill, turn the front wheels away from the curb to help keep the car from rolling. If there is no curb or if it is required by other conditions to keep the car from rolling, block the wheels.
- o Under some conditions your parking brake can freeze in the engaged position. This is most likely to happen when there is an accumulation of snow or ice around or near

DRIVING YOUR HYUNDAI

the rear brakes or if the brakes are wet. If there is a risk that the parking brake may freeze, apply it only temporarily while you put the gear selector lever in "P" (automatic) or in first or reverse gear (manual transaxle) and block the rear wheels so the car cannot roll. Then release the parking brake.

- o Do not hold the vehicle on the upgrade with the accelerator pedal. This can cause the transmission to overheat. Always use the brake pedal or parking brake.

C120A02A-AAT

ANTI-LOCK BRAKE SYSTEM (If installed)

The Anti-Lock Brake System (ABS) is designed to prevent wheel lock-up during sudden braking or on hazardous road surfaces. The ABS control module monitors the wheel speed and controls the pressure applied to each brake. Thus, in emergency situations or on slick roads, your ABS will increase vehicle control during braking.

NOTE:

During ABS operation, a slight pulsation may be felt in the brake pedal when the brakes are applied. Also, a noise may be heard in the engine compartment while driving. These conditions are normal and indicate that the anti-lock brake system is functioning properly.

WARNING:

Your ABS will not prevent accidents due to improper or dangerous driving maneuvers. Even though vehicle control is improved during emergency braking, always maintain a safe distance between you and objects ahead. Vehicle speeds should always be reduced during extreme road conditions.

The braking distance for cars equipped with an anti-lock braking system may be longer than for those without it in the following road conditions.

- o Driving on rough, gravel or snow-covered roads.
- o Driving with tire chains installed.
- o Driving on roads where the road surface is pitted or has different surface height.

These roads should be driven at reduced speeds. The safety features of an ABS equipped vehicle should not be tested by high speed driving or cornering. This could endanger the safety of yourself or others.

C140A01A-QAT

DRIVING FOR ECONOMY

You can save fuel and get more kilometers from your car if you follow these suggestions:

- o Drive smoothly. Accelerate at a moderate rate. Don't make "jack-rabbit" starts or full-throttle shifts and maintain a steady cruising speed. Don't race between stoplights.

Try to adjust your speed to that of the other traffic so you don't have to change speeds unnecessarily. Avoid heavy traffic whenever possible. Always maintain a safe distance from other vehicles so you can avoid unnecessary braking. This also reduces brake wear.

Drive at a moderate speed. The faster you drive, the more fuel your car uses. Driving at a moderate speed, especially on the highway, is one of the most effective ways to reduce fuel consumption.

Don't "ride" the brake or clutch pedal. This can increase fuel consumption and also increase wear on these components. In addition, driving with your foot resting on the brake pedal may cause the brakes to overheat, which reduces their effectiveness and may lead to more serious consequences.

Take care of your tires. Keep them inflated to the recommended pressure. Incorrect inflation, either too much or too little, results in unnecessary tire wear. Check the tire pressures at least once a month.

Be sure that the wheels are aligned correctly. Improper alignment can result from hitting curbs or driving too fast over irregular surfaces. Poor alignment causes faster tire wear and may also result in other problems as well as greater fuel consumption.

Keep your car in good condition. For better fuel economy and reduced maintenance costs, maintain your car in accordance with the maintenance schedule in Section 5. If

DRIVING YOUR HYUNDAI

you drive your car in severe conditions, more frequent maintenance is required (see Section 5 for details).

- o Keep your car clean. For maximum service, your Hyundai should be kept clean and free of corrosive materials. It is especially important that mud, dirt, ice, etc. not be allowed to accumulate on the underside of the car. This extra weight can result in increased fuel consumption and also contribute to corrosion.
- o Travellightly. Don't carry unnecessary weight in your car. Weight is an enemy of good fuel economy.
- o Don't let the engine idle longer than necessary. If you are waiting (and not in traffic), turn off your engine and restart only when you're ready to go.
- o Remember, your Hyundai does not require extended warm-up. As soon as the engine is running smoothly, you can drive away. In very cold weather, however, give your engine a slightly longer warm-up period.
- o Don't "lug" or "over"rev" the engine. Lugging is driving too slowly in too high a gear resulting in the engine bucking. If this happens, shift to a lower gear. Over-revving is racing the engine beyond its safe limit. This can be avoided by shifting at the recommended speeds.
- o Use your air conditioning sparingly. The air conditioning system is operated by engine power so your fuel economy is reduced when you use it.

C150A01A-AAT

SMOOTH CORNERING

Avoid braking or gear changing in corners, especially when roads are wet. Ideally, corners should always be taken under gentle acceleration. If you follow these suggestions, tire wear will be held to a minimum.

C160A01A-AAT

WINTER DRIVING

The more severe weather conditions of winter result in greater wear and other problems. To minimize the problems of winter driving, you should follow these suggestions:

C160B01A-GAT

Snowy or Icy Conditions

To drive your vehicle in deep snow, it may be necessary to use snow tires or to install tire chains on your tires. If snow tires are needed, it is necessary to select tires equivalent in size and type to the original equipment tires. Failure to do so may adversely affect the safety and handling of your car. Speeding, rapid acceleration, sudden brake applications, and sharp turns are potentially very hazardous practices. During deceleration, use engine braking to the fullest extent. Sudden brake applications on snowy or icy roads may cause skids to occur. You need to keep sufficient distance between the vehicle in front and your vehicle. Also, apply the brake gently. It should be noted that installing tire chains on the tire will provide a greater driving force, but will not prevent side skids.

NOTE:

Tire chains are not legal in all provinces. Check province laws before fitting tire chains.

C160C01A-AAT

Use High Quality Ethylene Glycol Coolant

Your Hyundai is delivered with high quality ethylene glycol coolant in the cooling system. It is the only type of coolant that should be used because it helps prevent corrosion in the cooling system, lubricates the water pump and prevents freezing. Be sure to replace or replenish your coolant in accordance with the maintenance schedule in Section 5. Before winter, have your coolant tested to assure that its freezing point is sufficient for the temperatures anticipated during the winter.

C160D01A-AAT

Check Battery and Cables

Winter puts additional burdens on the battery system. Visually inspect the battery and cables as described in Section 6. The level of charge in your battery can be checked by your Hyundai dealer or a service station.

C160E01A-AAT

Change to "Winter Weight" Oil if Necessary

In some climates it is recommended that a lower viscosity "winter weight" oil be used during cold weather. See Section 9 for recommen-

DRIVING YOUR HYUNDAI

dations. If you aren't sure what weight oil you should use, consult your Hyundai dealer.

C160F01A-AAT

Check Spark Plugs and Ignition System

Inspect your spark plugs as described in Section 6 and replace them if necessary. Also check all ignition wiring and components to be sure they are not cracked, worn or damaged in any way.

C160G01AGAT

To Keep Locks from Freezing

To keep the locks from freezing, squirt an approved de-icer fluid or glycerine into the key opening. If a lock is covered with ice, squirt it with an approved de-icing fluid to remove the ice. If the lock is frozen internally, you may be able to thaw it out by using a heated key. Mandrel the heated key with care to avoid burning your fingers.

NOTE:

The proper temperature for using the immobilizer key is from -40°C to 80°C . If you heat the immobilizer key over 80°C to open the frozen lock, it may cause damage to the transponder in its head.

C160H01A-AAT

Use Approved Anti-Freeze in Window Washer System

To keep the water in the window washer system from freezing, add an approved anti-freeze solution in accordance with instructions on the container. Window washer anti-freeze is available from Hyundai dealers and most auto parts outlets. Do not use engine coolant or other types of anti-freeze as these may damage the finish.

C160I01A-AAT

Don't Let Your Parking Brake Freeze

Under some conditions your parking brake can freeze in the engaged position. This is most likely to happen when there is an accumulation of snow or ice around or near the rear brakes or if the brakes are wet. If there is a risk the parking brake may freeze, apply it only temporarily while you put the gear selector lever in "P" (automatic) or in first or reverse gear (manual transaxle) and block the rear wheels so the car cannot roll. Then release the parking brake.

C160J01A-AAT

Don't Let Ice and Snow Accumulate Underneath

Under some conditions, snow and ice can build up under the fenders and interfere with the steering. When driving in severe winter conditions where this may happen, you should periodically check underneath the car to be sure the movement of the front wheels and the steering components are not obstructed.

C160K01A-AAT

Carry Emergency Equipment

Depending on the severity of the weather where you drive your car, you should carry appropriate emergency equipment. Some of the items you may want to carry include tire chains, tow straps or chains, flashlight, emergency flares, sand, a shovel, jumper cables, a window scraper, gloves, ground cloth, coveralls, a blanket, etc.

C170A01A-AAT

HIGH SPEED MOTORING

Pre-Trip Inspections

1. Tires;

Adjust the tire inflation pressures for highway driving. Low tire inflation pressures will result in overheating and possible failure of the tires. Avoid using worn or damaged tires which may result in reduced traction or tire failure.

NOTE:

Never exceed the maximum tire inflation pressure shown on the tires.

2. Fuel, engine coolant and engine oil; High speed travel consumes 1.5 times more fuel than urban motoring. Do not forget to check both engine coolant and engine oil.

3. Drive belt;

A loose or damaged drive belt may result in overheating of the engine.

DRIVING YOUR HYUNDAI

C180A01A-AAT

USE OF LIGHTS

Check your lights regularly for correct operation and always keep them clean. When driving during the day in conditions of poor visibility, it is helpful to drive with headlights on low beam. This enables you to be seen as well as to see.

C190A02A-GAT

TRAILER OR VEHICLE TOWING

If you are considering towing with your car, you should first check with your Province Department of Motor Vehicles to determine their legal requirements.

Since laws vary from province to province, the requirements for towing trailers, cars, other types of vehicles, or apparatus may differ. Ask your Hyundai dealer for further details before towing.

CAUTION:

Do not do any towing with your car during its first 2,000km (1,200 miles) in order to allow the engine to properly break in. Failure to heed this caution may result in serious engine or transaxle damage.

C190B01S-AAT

Trailer Hitches

Select the proper hitch and ball combination, making sure that its location is compatible with that of the trailer or vehicle being towed.

Use a quality non-equalizing hitch which distributes the tongue load uniformly throughout the chassis.

2-12

The hitch should be bolted securely to the car and installed by a qualified technician. DO NOT USE A HITCH DESIGNED FOR TEMPORARY INSTALLATION AND NEVER USE ONE THAT ATTACHES ONLY TO THE BUMPER.

C190C01Y-GAT

Trailer Brakes

If your trailer is equipped with a braking system, make sure it conforms to federal and/or local regulations and that it is properly installed and operating correctly.

NOTE:

If you tow a trailer or vehicle, your car will require more frequent maintenance due to the additional load. See "Maintenance Under Severe Usage Conditions" on page 5-4.

CAUTION:

- o Never connect a trailer brake system directly to the vehicle brake system.
- o When towing a trailer on steep grades (in excess of 12%) pay close attention to the engine coolant temperature gauge to ensure the engine does not overheat. If the needle of the coolant temperature gauge moves across the dial towards "H" (HOT), pull over and stop as soon as it is safe to do so, and allow the engine to idle until it cools down. You may proceed once the engine has cooled sufficiently.

C190001A-GAT

Safety Chains

Should the hitch connection between your car and the trailer or vehicle you are towing fail, the trailer or vehicle could wander dangerously across other lanes of traffic and ultimately collide with another vehicle. To eliminate this potential, a dangerous situation, safety chains, attached between your car and the trailer or towed vehicle, are required in most provinces.

C190E03A-GAT

Trailer Weight Limit

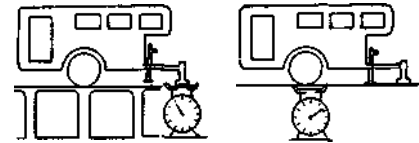

Tongue load

Total trailer weight

Tongue loads can be increased or decreased by redistributing the load in the trailer. This can be verified by checking the total weight of the loaded trailer and then checking the load on the tongue.

DRIVING YOUR HYUNDAI

NOTE:

1. Never load the trailer with more weight in the back than in the front. About 60% of the trailer load should be in the front half on the trailer and the remaining 40% in the rear.
2. The total gross vehicle weight with trailer must not exceed the Gross Vehicle Weight Rating (GVWR) shown on the vehicle identification plate (see page 8-1). The total gross vehicle weight is the combined weight of the vehicle, driver, all passengers and their luggage, cargo, hitch, trailer tongue load and other optional equipment.
3. The front or rear axle weight must not exceed the Gross Axle Weight Rating (GAWR) shown on the vehicle identification plate (see page 8-1). It is possible that your towing package does not exceed the GVWR but exceeds the GAWR. Improper trailer loading and/or too much luggage in the trunk can overload the rear axle. Redistribute the load and check the axle weight again.
4. The maximum permissible static vertical load on the coupling device is 50 kg.

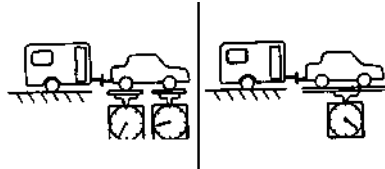

Gross axle weight

Gross vehicle weight

5. The maximum permissible overhang of the coupling point:
3/5 Door : 1,045 mm
4 Door : 1,095 mm

3/5 Door

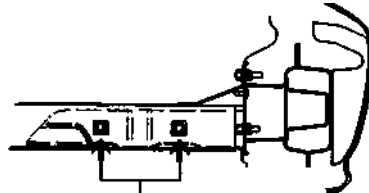

Coupling point

4 Door

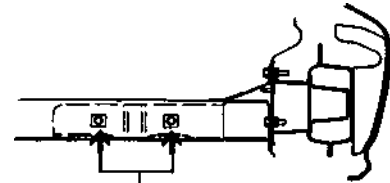

Coupling point

CAUTION:

The following specifications are recommended when towing a trailer. The loaded trailer weight cannot safely exceed the values in the chart below.

	Maximum Towable Weight		kg.
	Trailer	Tongue	
With Brake Type	1.3L	900	50
	1.5L	1100	
Without Brake Type	453		50

WARNING:

Improperly loading your car and trailer can seriously affect its steering and braking performance causing a crash in which you may be seriously injured.

DRIVING YOUR HYUNDAI

C190F02A-GAT

Trailer or Vehicle Towing Tips

1. Before towing, check hitch and safety chain connections as well as proper operation of the trailer running lights, brake lights, and turn signals.
2. Always drive your vehicle at a moderate speed (Less than 100 km/h).
3. Trailer towing requires more fuel than normal conditions.
4. To maintain engine braking efficiency and electrical charging performance, do not use fifth gear (manual transaxle) or overdrive (automatic transaxle).
5. Always secure items in the trailer to prevent load shift while driving.
6. Check the condition and air pressure of all tires on the trailer and your car. Low tire pressure can seriously affect the handling. Also check the spare tire.
7. The vehicle/trailer combination is more affected by crosswind and buffeting. When being passed by a large vehicle, keep a constant speed and steer straight ahead. If there is too much wind buffeting slow down to get out of the other vehicle's air turbulence.
8. When parking your car and trailer, especially on a hill, be sure to follow all the normal precautions. Turn your front wheel into the curb, set the parking brake firmly, and put the transaxle in 1st or Reverse (manual) or Park (automatic). In addition, place wheel chocks at each of the trailer's tires.

9. If the trailer has electric brakes, start your vehicle and trailer moving, and then apply the trailer brake controller by hand to be sure the brakes are working. This lets you check your electrical connection at the same time.
- I.O. During your trip, check occasionally to be sure that the load is secure, and that the lights and any trailer brakes are still working.
- H. Avoid jerky starts, sudden acceleration or sudden stops.
12. Avoid sharp turns and rapid lane changes.
13. Avoid holding the brake pedal down too long or too frequently. This could cause the brakes to overheat, resulting in reduced braking efficiency.
14. When going down a hill, shift into a lower gear and use the engine braking effect. When ascending a long grade, downshift the transaxle to a lower gear and reduce speed to reduce chances of engine overloading and/or overheating.
15. If you have to stop while going uphill, do not hold the vehicle in place by pressing on the accelerator. This can cause the automatic transaxle to overheat. Use the parking brake or footbrake.

NOTE:

When towing check transaxle fluid more frequently.

CAUTION:

If overheating should occur when towing, (temperature gauge reads near red zone), taking the following action may reduce or eliminate the problem.

1. Turn off the air conditioner.
2. Reduce highway speed.
3. Select a lower gear when going uphill.
4. While in stop and go traffic, place the gear selection in park or neutral and idle the engine at a higher speed.

WHAT TO DO IN AN EMERGENCY

3. TROUBLE ON THE ROAD

What to do in an Emergency

D010A01A-AAT

IF THE ENGINE WILL NOT START

CAUTION:

If the engine will not start, do not push or pull the car to start it. This could result in a collision or cause other damage. In addition, push or pull starting may cause the catalytic converter to be overloaded and create a fire hazard.

D010B01A-AAT

If Engine Doesn't Turn Over or Turns Over Slowly

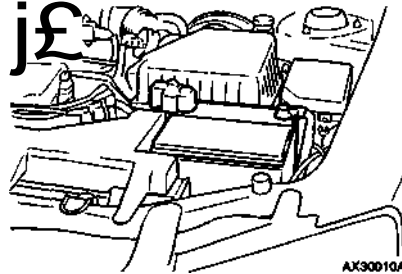

1. If your car has an automatic transaxle, be sure the gear selector lever is in "N" or "P" and the emergency brake is set.
2. Check the battery connections to be sure they are clean and tight.
3. Turn on the interior light. If the light dims or goes out when you operate the starter, the battery is discharged.
4. Check the starter connections to be sure they are securely tightened.
5. Do not push or pull the vehicle to start it. See instructions for "Jump Starting" on the following pages.

D010C01AGAT

If Engine Turns Over Normally but Does Not Start

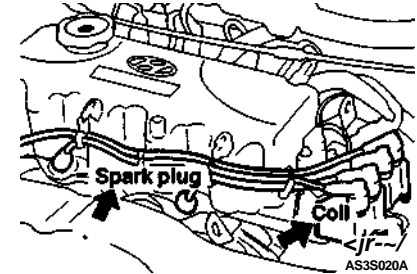

1. Check fuel level.
2. Check all connectors at ignition, coil and spark plugs. Reconnect any that may be disconnected or loose.
3. If you smell gasoline, the engine may be flooded. See starting instructions in Section 2. (For carburetor)
4. Check fuel line in the engine room.
5. If engine still refuses to start, call a Hyundai dealer or seek other qualified assistance.

D010D01A-AAT

If the Engine Stalls While Driving

1. Reduce your speed gradually, keeping a straight line. Move cautiously off the road to a safe place.
2. Turn on your emergency flashers.

WHAT TO DO IN AN EMERGENCY

3. Try to start the engine again. If your vehicle will not start, contact a Hyundai dealer or seek other qualified assistance.

D020A01A-AAT

JUMP STARTING

Negative to the engine
not to the battery Positive to positive

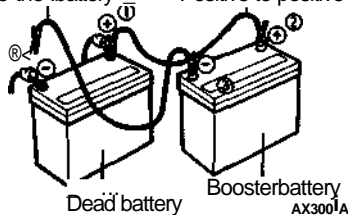

WARNING:

The gas produced by the battery during the jump-start operation is highly explosive. If these instructions are not followed exactly, serious personal injury and damage to the vehicle may occur! If you are not sure how to follow this procedure, seek qualified assistance. Automobile batteries contain sulfuric acid. This is poisonous and highly corrosive. When jump starting, wear protective glasses and be careful not to get acid on yourself, your clothing or on the car.

- o If you should accidentally get acid on your skin or in your eyes, immediately remove any contaminated clothing and flush the

3-2

area with clear water for at least 15 minutes. Then promptly obtain medical attention. If you must be transported to an emergency facility, continue to apply water to the affected area with a sponge or cloth.

- o The gas produced by the battery during the jump-start operation is highly explosive. Do not smoke or allow a spark or open flame in the vicinity.
- o The battery being used to provide the jump start must be 12-volt. If you cannot determine that it is a 12-volt battery, do not attempt to use it for the jump start.
- o To jump start a car with a discharged battery, follow this procedure exactly:

1. If the booster battery is installed in another vehicle, be sure the two vehicles are not touching.
2. Turn off all unnecessary lights and accessories in both vehicles.
3. Attach the clamps of the jumper cable in the exact order shown on the illustration. That is, first, attach one clamp of the jumper cable to the positive (+) post or cable of the discharged battery. Then attach the other end of the same cable to the positive (+) post or cable of the booster battery. Next, using the other cable, attach one clamp to the negative (-) post or cable of the booster battery. Then attach the other end of that cable to a solid metal part of the engine away from the battery. Do not connect the cable to any moving part.

4. Start the engine in the car with the booster battery and let it run for a few minutes. This will help to assure that the booster battery is fully charged. During the jumping operation, run the engine in this vehicle at about 2000 rpm.
5. Start your engine using the normal starting procedure. After the engine starts, leave the jumper cables connected and let the engine run at fast idle or about 2000 rpm for several minutes.
6. Following the exact reverse order of their being attached, carefully remove the jumper cables. Remove the negative cable first, then the positive cable.

If you do not know why your battery became discharged (because the lights were left on, etc.), have the charging system checked by your Hyundai dealer.

D030A01A-AAT

IF THE ENGINE OVERHEATS

If your temperature gauge indicates overheating, you experience a loss of power, or hear loud ping or knocking, the engine is probably too hot. If this happens, you should:

1. Pull off the road and stop as soon as it is safe to do so.
2. Place the gear selector lever in "P" (automatic), or neutral (manual transaxle) and set the parking brake. If the air conditioner is on, turn it off.

WHAT TO DO IN AN EMERGENCY

3. If coolant is running out under the car or steam is coming out from the hood, stop the engine. Do not open the hood until the coolant has stopped running or the steaming has stopped. If there is no visible loss of coolant and no steam, leave the engine running and check to be sure the engine cooling fan is operating. If the fan is not running, turn the engine off.
4. Check to see if the water pump drive belt is missing. If it is not missing, check to see that it is tight. If the drive belt seems to be satisfactory, check for coolant leaking from the radiator, hoses or under the car. (If the air conditioner had been in use, it is normal for cold water to be draining from it when you stop).

WARNING:

While the engine is running, keep hands, long hair and clothing away from moving parts such as the fan and drive belts to prevent injury.

5. If the water pump drive belt is broken or coolant is leaking out, stop the engine immediately and call the nearest Hyundai dealer for assistance.

WARNING:

Do not remove the radiator cap when the engine is hot. This may allow coolant to be blown out of the opening and cause serious burns.

6. If you cannot find the cause of the overheating, wait until the engine temperature has returned to normal. Then, if coolant has been lost, carefully remove the radiator cap and add water to bring the fluid level in the reservoir up to the halfway mark.
7. Proceed with caution, keeping alert for further signs of overheating. If overheating happens again, call a Hyundai dealer for assistance.

CAUTION:

Serious loss of coolant indicates there is a leak in the cooling system and this should be checked as soon as possible by a Hyundai dealer.

D040A01A-GAT

SPARE TIRE

The following instructions for the FULL SIZE spare tire should be observed:

Check inflation pressure as soon as practical after installing the spare tire, and adjust to the specified pressure. The tire pressure should be periodically checked and maintained at the specified pressure while the tire is stored.

Spare Tire Pressure

Tire Size	Full Size
Inflation Pressure	210kPa(30psi)

D040B01A-AAT

Handling the Spare Tire

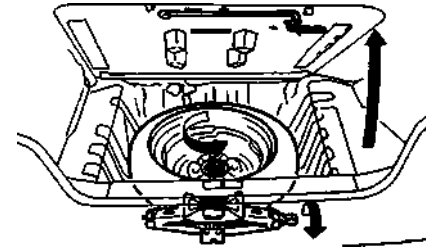

Remove the installation bolt to remove the spare tire. To replace the spare tire in its storage compartment, tighten the bolt firmly with your fingers until there is no more play in the spare tire.

D050A01A-AAT

IF YOU HAVE A FLAT TIRE

If a tire goes flat while you are driving:

1. Take your foot off the accelerator pedal and let the car slow down while driving straight ahead. Do not apply the brakes immediately or attempt to pull off the road as this may cause a loss of control. When the car has slowed to such a speed that it is safe to do so, brake carefully and pull off the road. Drive off the road as far as possible and park on firm, level ground. If you are on a

WHAT TO DO IN AN EMERGENCY

divided highway, do not park in the median area between the two traffic lanes.

2. When the car is stopped, turn on your emergency hazard flashers, set the parking brake and put the transaxle in "P" (automatic) or reverse (manual transaxle).
3. Have all passengers get out of the car. Be sure they all get out on the side of the car that is away from traffic.
4. Change the tire following the instructions provided on the following pages.

D060A01AAAT

CHANGING A FLAT TIRE

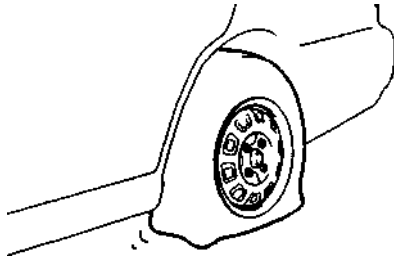

The procedure described on the following pages can be used to rotate tires as well as to change a flat tire. When preparing to change a flat tire, check to be sure the gear selector lever is in "P" (automatic) or reverse gear (manual transaxle) and that the parking brake is set, then:

3-4

D060B01AAAT

1. Obtain Spare Tire and Tool

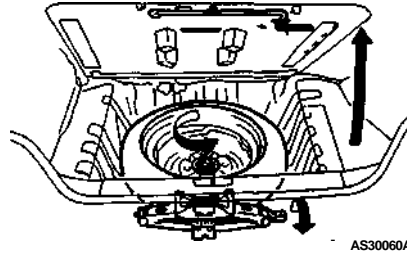

Remove the spare tire and take out the jack, jack handle, and tool bag from the trunk.

NOTE:

The jack handle is located beneath the luggage mat in the vehicle trunk.

D060C01A AAT

2. Block the Wheel

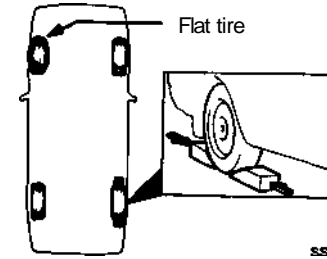

Block the wheel that is diagonally opposite from the flat to keep the vehicle from rolling when the car is raised on the jack.

D060001 A-AAT

3. Loosen Wheel Nuts

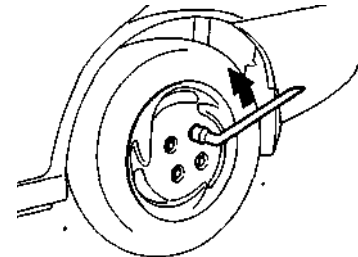

WHAT TO DO IN AN EMERGENCY

The wheel nuts should be loosened slightly before raising the car. To loosen the nuts, turn the wrench handle counterclockwise. When doing this, be sure that the socket is seated completely over the nut so it cannot slip off. For maximum leverage position the wrench so the handle is to the right as shown in the drawing. Then, while holding the wrench near the end of the handle, pull up on it with steady pressure. Do not remove the nuts at this time. Just loosen them about one-half turn.

0060E01A-AAT

4. Put the Jack in Place

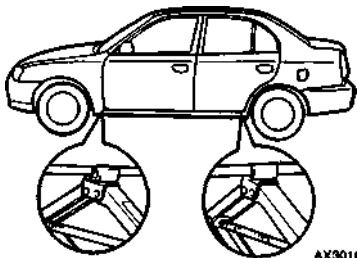

The base of the jack should be placed on firm, level ground. The jack should be positioned as shown in the drawing.

D060F01A-AAT

5. Raising the Car

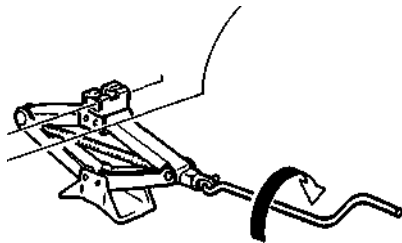

Install the jack handle into the jack as shown in the drawing. To raise the vehicle, turn the jack handle clockwise. As the jack begins to raise the vehicle, double check that it is properly positioned and will not slip. If the jack is on soft ground or sand, you may find it necessary to place a board, brick, flat stone or other object under the base of the jack to keep it from sinking.

Raise the car high enough so that the fully inflated spare tire can be installed. To do this, you will need more ground clearance than is required to remove the flat tire.

WARNING:

Do not get under the car when it is supported by the jack! The vehicle could fall and cause serious injury or death. No one should stay in the car while the jack is being used.

D060G01A-AAT

6. Changing Wheels

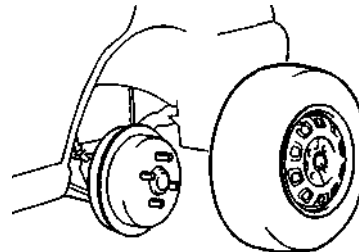

Use the wrench to loosen the wheel nuts, then remove them with your fingers. Remove the wheel cover (if installed) from the wheel and slide the wheel off the studs and lay it flat so it cannot roll away. To put the wheel on the hub, pick up the spare tire, line up the holes with the studs and slide the wheel onto them. If this is difficult, tip the wheel slightly and get the top hole in the wheel lined up with the top stud. Then jiggle the wheel back and forth until the wheel can be slid over the other studs.

WHAT TO DO IN AN EMERGENCY

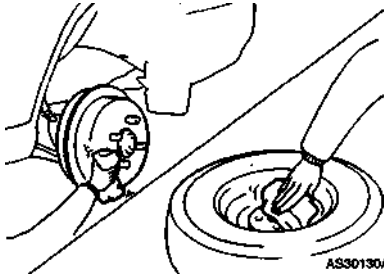

WARNING:

Wheel covers may have sharp edges. Handle them carefully to avoid possible severe injury.

Before putting the wheel into place, be sure that there is nothing on the hub or wheel (such as mud, tar, gravel, etc.) that interferes with the wheel fitting solidly against the hub. If there is, remove it. If there is not good contact on the mounting surface between the wheel and hub, the wheel nuts could come loose and cause the loss of a wheel. Loss of a wheel may result in loss of control of the vehicle. This may cause serious injury or death.

D060H01A-AAT

7. Re-install Wheel Nuts

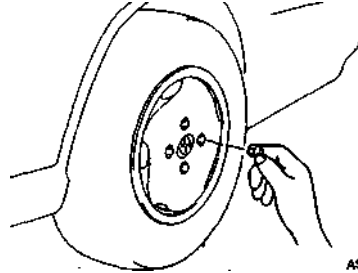

To re-install the wheel cover, hold it on the wheel and put the wheel nuts on the studs and tighten them finger tight. The nuts should be installed with their small diameter ends directed inward. Jiggle the tire to be sure it is completely seated, then tighten the nuts with your fingers again.

D06001A-GAT

8. Lower Vehicle and Tighten Nuts

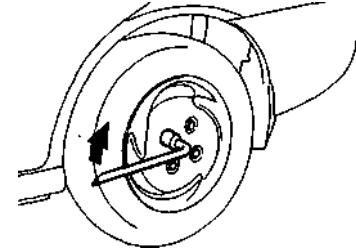

Lower the car to the ground by turning the jack handle counterclockwise. Then position the wrench as shown in the drawing and tighten the wheel nuts. Be sure the socket is seated completely over the nut. Do not stand on the wrench or use an extension pipe over the wrench handle.

Go around the wheel tightening every other nut until they are all tight. Then double-check each nut for tightness. After changing wheels, have a technician tighten the wheel nuts to their proper torque as soon as possible.

Wheel nut tightening torque:

Steel wheel & aluminium alloy wheel:
900-1,100 kg.cm (65-80 lb.ft)

WHAT TO DO IN AN EMERGENCY

0060J01A AAT

AFTER CHANGING WHEELS

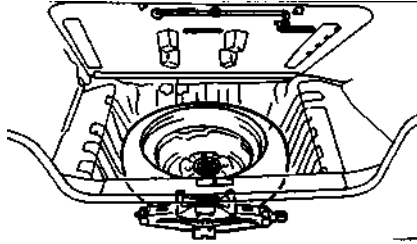

If you have a tire gauge, remove the valve cap and check the air pressure. If the pressure is lower than recommended, drive slowly to the nearest service station and inflate to the correct pressure. If it is too high, adjust it until it is correct. Always re-install the valve cap after checking or adjusting tire pressure. If the cap is not replaced, air may leak from the tire. If you lose a valve cap, buy another and install it as soon as possible.

After you have changed wheels, always secure the flat tire in its place in the trunk and return the jack, jack handle, and tools to their proper storage locations.

0080A02A-GAT

IF YOUR CAR MUST BE TOWED



OK FOR AUTOMATIC OR MANUAL
TRANSAXLE EQUIPPED VEHICLE

CAUTION:

Your car can be damaged if towed Incorrectly!

If your car has to be towed, it should be done by your Hyundai dealer or a commercial tow truck service. This will help assure that your car is not damaged in towing. Also, professionals are generally aware of local laws governing towing. In any case, rather than risk damage to your car, it is suggested that you show this information to the tow truck operator. Be sure that a safety chain system is used and that local laws are observed.

DOB0B01A-AAT

TOWING A CAR WITH MANUAL TRANSAXLE



OK FOR AUTOMATIC OR MANUAL
TRANSAXLE EQUIPPED VEHICLE
WITH NO DAMAGE

If the car is being towed with the rear wheels on the ground, be sure the parking brake is released.

If the car is being towed with the front wheels on the ground, be sure that the transaxle is in neutral. Also, be sure that the ignition key is in the "ACC" position. This is necessary to prevent damage to the steering lock mechanism, which is not designed to hold the front wheels straight while the car is being towed.

If any of the loaded wheels or suspension components are damaged, a towing dolly must be used.

WHAT TO DO IN AN EMERGENCY

D080C01A-GAT

TOWING A CAR WITH AUTOMATIC TRANSAXLE

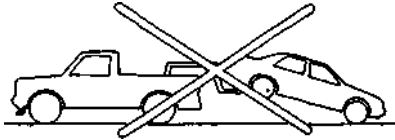

- o NOT OK FOR AUTOMATIC TRANSAXLE EQUIPPED VEHICLE
- o OK FOR MANUAL TRANSAXLE

CAUTION:

A car with an automatic transaxle should never be towed from the rear with the front wheels on the ground. This can cause serious damage to the transaxle. If the car must be towed from the rear, a towing dolly must be used under the front wheels.

- o If the car is being towed with the rear wheels on the ground, be sure the parking brake is released
- o If the car is being towed with all four wheels on the ground, it can be towed only from the front. Be sure that the transaxle is in neutral. Do not tow at speeds greater than 50 km/h (25 mph) and for more than 25 km (15 miles).
Be sure the steering is unlocked by placing the key in the "ACC" position. A driver must

be in the towed vehicle to operate the steering and brakes.

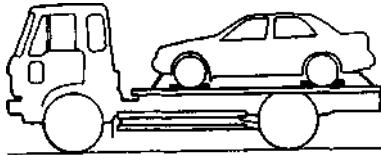

o OK FOR AUTOMATIC OR MANUAL TRANSAXLE EQUIPPED VEHICLE

NOTE:

Before towing, check the level of the transaxle fluid. If it is below the "HOT" mark on the dipstick, add fluid. If you cannot add fluid, a towing dolly must be used.

D080C01A-AAT

EMERGENCY TOWING

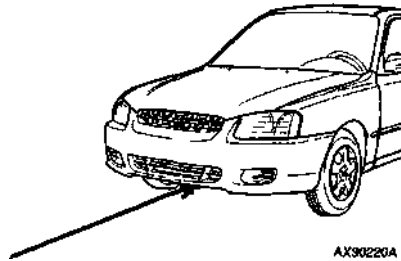

AX90220A

For emergency towing when no commercial tow vehicle is available, attach a tow cable, chain or strap to one of the tie-down hooks under the front of your car. Do not attempt to tow your vehicle in this manner on any unpaved surface. This may result in serious damage to your car.

Nor should it be attempted if the wheels, drive train, axles, steering or brakes are damaged. Before towing, be sure the transaxle is in neutral and the key in "ACC" (with the engine off) or in the "ON" position (with the engine running). A driver must be in the towed car to steer it and operate the brakes.

D120A01A-QAT

IF YOU LOSE YOUR KEYS

If you lose your keys, many Hyundai dealers can make you a new key if you have your key number.

If you lock the keys inside your car and you cannot obtain a new key, many Hyundai dealers can use special tools to open the door for you.

Information about the key of immobilizer system (if installed) will be found on page 1-2.

CORROSION PREVENTION AND APPEARANCE CARE

ZE010A1 -A

4. KEEPING THOSE GOOD LOOKS Corrosion Prevention & Appearance Care

E010A01A-AAT

CORROSION PROTECTION

Protecting Your Hyundai from Corrosion

By using the most advanced design and construction practices to combat corrosion, Hyundai produces cars of the highest quality. However, this is only part of the job. To achieve the long term corrosion resistance your Hyundai can deliver, the owner's cooperation and assistance is also required.

E010B01A-AAT

Common Causes of Corrosion

The most common causes of corrosion on your car are:

- o Road salt, dirt and moisture that is allowed to accumulate underneath the car.
- o Removal of paint or protective coatings by stones, gravel, abrasion or minor scrapes and dents which leave unprotected metal exposed to corrosion.

E010C01A-AAT

High-Corrosion Areas

If you live in an area where your car is regularly exposed to corrosive materials, corrosion protection is particularly important. Some of the common causes of accelerated corrosion are road salts, dust control chemicals, ocean air and industrial pollution.

E010D01A-AAT

Moisture Breeds Corrosion

Moisture creates the conditions in which corrosion is most likely to occur. For example, corrosion is accelerated by high humidity, particularly when temperatures are just above freezing. In such conditions, the corrosive material is kept in contact with the car surfaces by moisture that is slow to evaporate.

Mud is a particular enemy of corrosion protection because it is slow to dry and holds moisture in contact with the vehicle. Even though the mud appears to be dry, it can still retain moisture and promote corrosion.

High temperatures can also accelerate corrosion of parts that are not properly ventilated so the moisture can be dispersed. For all these reasons, it is particularly important to keep your car clean and free of mud or accumulations of other materials. This applies not only on the visible surfaces but particularly to the underside of the car.

E020A01A-AAT

TO HELP PREVENT CORROSION

You can help prevent corrosion from getting started by observing the following:

E020B01A-AAT

Keep Your Car Clean

The best way to prevent corrosion is to keep your car clean and free of corrosive materials. Attention to the underside of the car is particularly important.

- o If you live in a high-corrosion area—where road salts are used, near the ocean, areas with industrial pollution, acid rain, etc.—you should take extra care to prevent corrosion. In winter, hose off the underside of your car at least once a month and be sure to clean the underside thoroughly when winter is over.
- o When cleaning underneath the car, give particular attention to the components under the fenders and other areas that are hidden from view. Do a thorough job; just dampening the accumulated mud rather than washing it away will accelerate corrosion rather than prevent it. Water under high pressure and steam are particularly effective in removing accumulated mud and corrosive materials.
- o When cleaning lower door panels, rocker panels and frame members, be sure that drain holes are kept open so that moisture can escape and not be trapped inside to accelerate corrosion.

CORROSION PREVENTION AND APPEARANCE CARE

E020C01A-AAT

Keep Your Garage Dry

Don't park your car in a damp, poorly ventilated garage. This creates a favorable environment for corrosion. This is particularly true if you wash your car in the garage or drive it into the garage when it is still wet or covered with snow, ice or mud. Even a heated garage can contribute to corrosion unless it is well ventilated so moisture is dispersed.

E020D01A-AAT

Keep Paint and Trim in Good Condition

Scratches or chips in the finish should be covered with "touch-up" paint as soon as possible to reduce the possibility of corrosion. If bare metal is showing through, the attention of a qualified body and paint shop is recommended.

E020E01A-AAT

Don't Neglect the Interior

Moisture can collect under the floor mats and carpeting to cause corrosion. Check under the mats periodically to be sure the carpeting is dry. Use particular care if you carry fertilizers, cleaning materials or chemicals in the car. These should be carried only in proper containers and any spills or leaks should be cleaned up, flushed with clear water and thoroughly dried.

E030A01A-AAT

WASHING AND WAXING

Washing Your Hyundai

Never wash your car when the surface is hot from being in the sun. Always wash your car in the shade.

Wash your car frequently. Dirt is abrasive and can scratch the paint if it is not removed. Air pollution or acid rain may damage the paint and trim through chemical action if pollutants are allowed to remain in contact with the surface. If you live near the ocean or in an area where road salts or dust control chemicals are used, you should pay particular attention to the underside of the car. Start by rinsing the car to remove dust and loose dirt. In winter, or if you have driven through mud or muddy water, be sure to thoroughly clean the underside as well. Use a hard direct stream of water to remove accumulations of mud or corrosive materials. Use a good quality car-washing solution and follow the manufacturer's directions on the package. These are available at your Hyundai dealer or auto parts outlet. Don't use strong household detergents, gasoline, strong solvents or abrasive cleaning powders as these may damage the finish.

Use a clean sponge or cloth, rinse it frequently and don't damage the finish by rubbing too hard. For stubborn spots, dampen them frequently and remove them a little at a time.

To clean whitewall tires, use a stiff brush or soap-impregnated steel-wool scouring pad.

To clean plastic wheel covers, use a clean sponge or soft cloth and water.

To clean cast aluminum alloy wheels, use a mild soap or neutral detergent. Do not use abrasive cleaners. Protect the bare-metal surfaces by cleaning, polishing and waxing. Because aluminum is subject to corrosion, be sure to give aluminum alloy wheels special attention in winter. If you drive on salted roads, clean the wheels thoroughly afterwards.

After washing, be sure to rinse thoroughly. If soapy water dries on the finish, streaking will result.

When the weather is warm and the humidity low, you may find it necessary to rinse each section immediately after washing to avoid streaking.

After rinsing, dry the car using a damp chamois or soft, absorbent cloth. The reason for drying the car is to remove water from the car so it will dry without water spots. Don't rub, this can damage the finish.

If you find any nicks or scratches in the paint, use touch-up paint to cover them to prevent corrosion. To protect the paintwork of the car against corrosion, you must clean your Hyundai

CORROSION PREVENTION AND APPEARANCE CARE

(at least once a month). Give special attention to the removal of salt, mud and other substances on the underside of the splashboards of the car. Make sure that the outlets and the underside of the doors are open. Paint damage can be caused by small accumulation of tar, industrial precipitation, tree resin, insects and bird droppings, when not removed immediately. If water alone is not strong enough to remove the accumulated dirt, use a mild car washing solution. Be sure to rinse the surface after washing to remove the solution. Never allow the solution to dry on the painted surfaces.

E030B01A-AAT

Spot Cleaning

Don't use gasoline, strong solvents or corrosive cleaning agents. These can damage the finish of the car. To remove road tar, use turpentine on a clean, soft cloth. Be gentle. To remove dead insects or tree sap, use warm water and mild soap or car-washing solution. Soak the spot and rub gently. If the paint has lost its luster, use a commercial car-cleaning polish.

E030C01A-AAT

Polishing and Waxing

Always wash and dry the car before polishing or waxing or using a combination cleaner and wax. Use a good quality commercial product and follow the manufacturer's directions on the container. Polish and wax the bright trim pieces as well as the paint.

E030O01A-AAT

When to Wax Again

You should polish and wax the car again when water no longer beads on a clean surface but spreads out over a larger area.

E030E01A-AAT

Maintaining Bumpers

Special precautions must be observed to preserve the appearance of the bumpers on your Hyundai. They are:

- o Be careful not to spill battery electrolyte or hydraulic brake fluid on the bumpers. If you do, wash it off immediately with clean water.
- o Be gentle when cleaning the bumper surfaces. They are made of soft plastic and the surface can be damaged if mistreated. Do not use abrasive cleaners. Use warm water and mild soap or car-washing solution.

- o Do not expose the bumpers to high temperatures. For example, if you have your car repainted, do not leave the bumpers on the car if the car is going to be placed in a high-temperature paint booth.

E040A01A-AAT

CLEANING THE INTERIOR

To Clean the Vinyl Upholstery

To clean the vinyl upholstery, first remove loose dirt and dust with a vacuum cleaner. Then apply a solution of mild soap or detergent and water using a clean sponge or soft cloth. Allow this to stay on the surface to loosen the dirt, then wipe with a clean damp sponge or cloth. If all the dirt stains are not removed, repeat this procedure until the upholstery is clean. Do not use gasoline, solvent, paint thinner or other strong cleaners.

E040B01A-AAT

To Clean the Leather Upholstery (If Installed)

In the normal course of use, leather upholstered surfaces will, like any material, pick-up dust and dirt. This dust and dirt must be cleaned off or it may work into the surface of the leather, causing damage.

Fine leather needs care, and should be cleaned when necessary. Washing leather thoroughly with soap and water will keep your leather lustrous, beautiful and ensure you have many years of wear.

CORROSION PREVENTION AND APPEARANCE CARE

Take a piece of cheese cloth and using any mild soap and lukewarm water, work up a good lather. Thoroughly wash the leather. Wipe clean with a slightly damp cloth and dry with soft cloth. Do this as often as the leather becomes soiled.

During tanning operations, sufficient oils are incorporated through processing that noneneed be applied during the life of the leather. Oil applled to the finished surface will in no way help the leather and may do more harm than good. Varnishes and fumiture pollshes should never be used under any conditions.

E040C01A-AAT

Cleaning the Carpets

Use a foam-type carpet cleaner. Cleaners of this type are available in aerosol cans in liquid form or powder. Read the instructions and follow them exactly. Using a vacuum cleaner with the appropriate attachment, remove as much dirt from the carpets as possible. Apply the foam following the manufacturer's directions, then rub in overlapping circles. Do not add water. These cleaners work best when the carpet is kept as dry as possible.

E040O01AAAT

Cleaning the Seat Belts

To clean the seat belts, use a cloth or sponge with mild soap or detergent and warm water. Do not use strong detergents, dye, bleach orabrasive materials on the seat belts as this may weaken the fabric.

While Cleaning the belts, inspect them for excessive wear, cuts, fraying or other signs of damage and replace them if necessary.

E040E01A-AAT

Cleaning the Windows

You may use any household window cleaner on the windows. However, when cleaning the inside of the rear window be careful not to damage the rear window defroster wiring.

E050A01A-AAT

Any Questions?

If you have any questions about the care of your car, consult your Hyundai dealer.

VEHICLE MAINTENANCE REQUIREMENTS

5. THE KEY TO TROUBLE-FREE OPERATION

Vehicle Maintenance Requirements

F010A01A-GAT

MAINTENANCE INTERVALS

Service requirements

To assure that you receive the greatest number of kilometers of satisfying operation from your Hyundai, certain maintenance procedures must be performed. Although careful design and engineering have reduced these to a minimum, those that are required are of the utmost importance.

It is your responsibility to have these maintenance procedures performed to comply with the terms of the warranties covering your new Hyundai. The Service Passport supplied with your new vehicle provides further information about these warranties.

F010B01A-AAT

Maintenance Requirements

The maintenance required for your Hyundai can be divided into three main areas:

- o Specified scheduled procedures
- o General everyday checks
- o Do-it-yourself maintenance

F010C01A-QAT

Specified Scheduled Procedures

These are the procedures such as inspections, adjustments and replacements that are listed in the maintenance charts starting on page 5-2. These procedures must be performed at the intervals shown in the maintenance schedule to assure that your warranty remains in effect. Although it is strongly recommended that they be performed by the factory-trained or distributor-trained technicians at your Hyundai dealer, these procedures may be performed at any qualified service facility.

It is suggested that genuine Hyundai service parts be used for any required repairs or replacements. Other parts of equivalent quality such as engine oil, engine coolant, manual or auto transaxle oil, brake fluid and so on which are not supplied by Hyundai Motor Company or its distributor may be used without affecting your warranty coverage but you should always be sure these are equivalent to the quality of the original Hyundai parts. Your Service Passport provides further information about your warranty coverage.

F010D01A-GAT

General Everyday Checks

These are the everyday checks you should perform each time you drive your Hyundai or when you fill the fuel tank. A list of these items will be found on page 6-4.

F010E01A-AAT

Do-It-Yourself Maintenance

If you are mechanically inclined, own a few tools that are required and want to take the time to do so, you can inspect and service a number of items. For more information about doing it yourself, see Section 6.

F010F01A-AAT

A Few Tips

- o Whenever you have your Hyundai serviced, keep copies of the service records in your glovebox. This will help assure that you can document that the required procedures have been performed to keep your warranties in effect. This is especially important when service is not performed by an authorized Hyundai dealer.
- o If you choose to do your own maintenance and repairs, you may find it helpful to have an official Hyundai Shop Manual. A copy of this publication may be purchased at your Hyundai dealer's parts department.

F020A01A-GAT

SCHEDULED MAINTENANCE REQUIREMENTS

Inspection should be performed any time a malfunction is experienced or suspected. Receipts for all emission control system services should be retained to demonstrate compliance with conditions of the emissions system warranty.

For severe usage maintenance requirements, see page 5-4 of this section.

VEHICLE MAINTENANCE REQUIREMENTS

F030A01A-GAT

SCHEDULED MAINTENANCE

The following maintenance services must be performed to assure good vehicle control and performance. Keep receipts for all vehicle services to protect your warranty.

Where both mileage and time are shown, the frequency of service is determined by whichever occurs first.

F030B02A-GAT

R : Replace I: Inspect and, after inspection, clean, adjust, repair or replace if necessary

NO	DESCRIPTION	KILOMETERSX1000	15	30	45	60	75	90	105	120
		MONTHS	12	24	36	48	60	72	84	96
ENGINE CONTROL SYSTEM MAINTENANCE										
1	ENGINE OIL & FILTER (SG OR ABOVE) See Note (1)		R	R	R	R	R	R	R	R
2	DRIVE BELT (WATER PUMP, ALTERNATOR & A/CON)			I		I		I		I
3	FUEL FILTER (MF)					R				R
	FUEL FILTER (CARBURETOR)			I		R		I		R
4	FUEL LINES, FUEL HOSES & CONNECTIONS		I	I	I	I	I	I	I	I
5	TIMING BELT					I		R		
6	VAPOR HOSE & FUEL FILLER CAP			I		I		I		I
7	VACUUM CRANKCASE VENTILATION HOSES			I		I		I		I
8	AIR CLEANER FILTER		I	R	I	R	I	R	I	R
9	SPARKPLUGS			I	R		I	R		I
10	IGNITION TIMING (CARB ONLY)			I		I		I		I
11	IDLE SPEED & CO (CARB ONLY)		I	I	I	I	I	I	I	I

Note: (1) SF OR LOWER : EVERY 10,000 KM OR 6 MONTHS: "R"

VEHICLE MAINTENANCE REQUIREMENTS

F030C05A-QAT

R: Replace I: Inspect and, after inspection, clean, adjust, repair or replace if necessary

NO.	DESCRIPTION	KILOMETERSX1000		15	30	45	60	75	90	105	120
		MONTHS		12	24	36	48	60	72	84	96
GENERAL MAINTENANCE											
1	COOLINGSYSTEM	I	I	I	I	I	I	I	I	I	I
2	ENGINECOOLANT	See Note (2)									
3	MANUAL TRANSAXLE OIL		R		R		R		R		R
4	AUTOMATIC TRANSAXLE European Community Only	I	I	I	I	I	I	R	I	I	
	FLUID Except European Community	I	I	I	I	I	I	1	I	I	
5	BRAKE HOSES AND LINES	I	I	I	I	I	I	1	I	I	
6	BRAKE FLUID		I		I		I	1		I	
7	REAR BRAKE DRUMS/LININGS, PARKING BRAKE		I		I		I	1		I	
8	BRAKE PADS, CALIPERS AND ROTORS	I	I	I	I	I	I	1	I	I	
9	EXHAUST PIPE AND MUFFLER	I	I	I	I	I	I	1	I	I	
10	SUSPENSION MOUNTING BOLTS	I	I	I	I	I	I	1	I	I	
11	STEERING GEAR BOX, LINKAGE & BOOTS/LOWER ARM BALL JOINT	I	I	I	I	I	I	1	I	I	
12	POWER STEERING PUMP, BELT AND HOSES	I	I	I	I	I	I	1	I	I	
13	DRIVESHAFTS AND BOOTS		I		I		I	1		I	
14	AIR CONDITIONING REFRIGERANT	I	I	I	I	I	I	1	I	I	
15	AIR FILTER (For Evaporator and Blower Unit)	R	R -	R	R	R	R	R	R	R	R

Note : (2) FOR EVERY 24 MONTHS OR 45,000 KM, WHICHEVER OCCURS FIRST : "R"

VEHICLE MAINTENANCE REQUIREMENTS

F060A01A-AAT

EXPLANATION OF SCHEDULED MAINTENANCE ITEMS

F060M01A-AAT

o Engine oil and filter

The engine oil and filter should be changed at the intervals specified in the maintenance schedule. If the car is being driven in severe conditions, more frequent oil and filter changes are required.

F060B01A-AAT

o Drive belts

Inspect all drive belts for evidence of cuts, cracks, excessive wear or oil and replace if necessary. Drive belts should be checked periodically for proper tension and adjusted as necessary.

F060C01A-AAT

o Fuel filter

A clogged filter can limit the speed at which the vehicle may be driven, damage the emission system and cause hard starting. If an excessive amount of foreign matter accumulates in the fuel tank, the filter may require replacement more frequently.

After installing a new filter, run the engine for several minutes, and check for leaks at the connections.

Fuel filters should be installed by trained technicians.

F060D01A-AAT

o Fuel lines, fuel hoses and connections

Check the fuel lines, fuel hoses and connections for leakage and damage. Have a trained technician, replace any damaged or leaking parts immediately.

F060E01A-AAT

o Timing belt

Inspect all parts related to the timing belt for damage and deformation. Replace any damaged parts immediately.

F060Q01A AAT

o Vapor hose and fuel filler cap

The vapor hose and fuel filler cap should be inspected at those intervals specified in the maintenance schedule. Make sure that a new vapor hose or fuel filler cap is correctly placed.

F060F01A-AAT

o Vacuum, crankcase ventilation hoses

Inspect the surface of hoses for evidence of heat and/or mechanical damage. Hard and brittle rubber, cracking, tears, cuts, abrasions, and excessive swelling indicate deterioration. Particular attention should be paid to examine those hose surfaces nearest to high heat sources, such as the exhaust manifold.

Inspect the hose routing to assure that the hoses do not come in contact with any heat source, sharp edges or moving component which might cause heat damage or mechanical wear. Inspect all hose connections, such as clamps and couplings, to make sure they are secure, and that no leaks are present. Hoses should be replaced immediately if there is any evidence of deterioration or damage.

F060H01A-AAT

o Air cleaner filter

A Genuine Hyundai air cleaner filter is recommended when filter is replaced.

F060J01A-AAT

o Spark plugs

Make sure to install new spark plugs of the correct heat range.

F060K01A-QAT

o Ignition timing

For basic ignition timing, refer to the Specifications in Section 9.

F060L01A-GAT

o Idle speed and CO

After warming up the engine, check and adjust the idle speed and CO. For detailed service procedures and specification, refer to the Shop Manual.

VEHICLE MAINTENANCE REQUIREMENTS

F070B01A-QAT

o Cooling System

Check the cooling system part, such as radiator, coolant reservoir, hoses and connections for leakage and damage. Replace any damaged parts.

F070C01A-AAT

o Engine coolant

The coolant should be changed at the intervals specified in the maintenance schedule.

F070D01A-AAT

o Manual transaxle oil

Inspect the manual transaxle oil according to the maintenance schedule.

NOTE:

If the oil level is low, check for possible leaks before adding oil. Do not overfill.

F070E03A-AAT

o Automatic transaxle fluid

The fluid level should be in the "HOT" range of the dipstick, after engine and transaxle are at normal operating temperature. Check the Automatic Transaxle Fluid level with the engine running and the transaxle in neutral, with the parking brake properly applied. Use HYUNDAI ATF SP-II M or GENUINE DIAMOND ATF SP-II M when adding or changing fluid.

o Brake hoses and lines

Visually check for proper installation, chafing, cracks, deterioration and any leakage. Replace any deteriorated or damaged parts immediately.

F070G01A-AAT

o Brake fluid

Check brake fluid level in the brake fluid reservoir. The level should be between "MIN" and "MAX" marks on the side of the reservoir. Use only hydraulic brake fluid conforming to DOT 3.

F070H01A-AAT

o Rear brake drums/linings, parking brake

Check the rear brake drums and linings for scoring, burning, leaking fluid, broken parts, and excessive wear. Inspect the parking brake system including the parking brake lever and cables. For detailed service procedures, refer to the Shop Manual.

F070J01A-AAT

o Brake pads, calipers and rotors

Check the pads for excessive wear, discs for run out and wear, and calipers for fluid leakage.

F070K01A-AAT

o Exhaust pipe and muffler

Visually inspect the exhaust pipes, muffler and hangers for cracks, deterioration, or damage. Start the engine and listen carefully for any exhaust gas leakage. Tighten connections or replace parts as necessary.

F070L01A-AAT

o Suspension mounting bolts

Check the suspension connections for looseness or damage. Retighten to the specified torque.

F070M01A-AAT

o Steering gear box, linkage & boots/ lower arm ball joint

With the vehicle stopped and engine off, check for excessive free-play in the steering wheel. Check the linkage for bends or damage. Check the dust boots and ball joints for deterioration, cracks, or damage. Replace any damaged parts.

F070N01A-AAT

o Power steering pump, belt and hoses

Check the power steering pump and hoses for leakage and damage. Replace any damaged or leaking parts immediately. Inspect the power steering belt for evidence of cuts, cracks, excessive wear, oiliness and proper tension. Replace or adjust it if necessary.

VEHICLE MAINTENANCE REQUIREMENTS

F070P01A-AAT

o Driveshafts and boots

Check the drive shafts, boots and clamps for cracks, deterioration, or damage. Replace any damaged parts and, if necessary, repack the grease.

F070O01A-AAT

o Air conditioning refrigerant

Check the air conditioning lines and connections for leakage and damage. Check air conditioning performance according to the relevant shop manual if necessary.

DO-IT-YOURSELF MAINTENANCE

6. SATURDAY MECHANICS

Do-It-Yourself Maintenance

Q010A02A-AAT

ENGINE COMPARTMENT (For Multiport Fuel Injection)

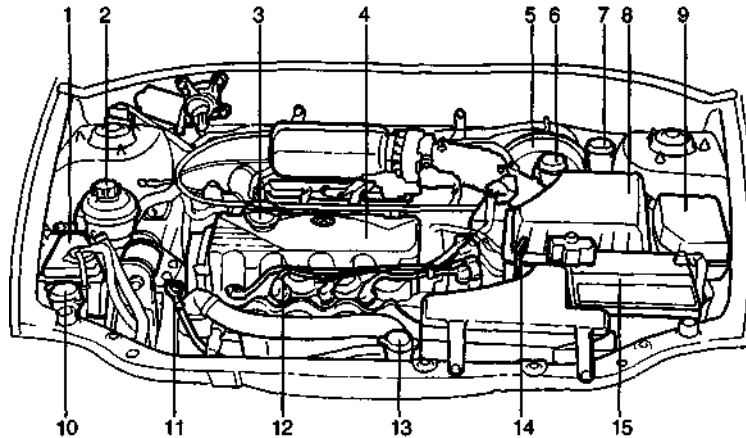

1. Engine coolant reservoir
2. Power steering fluid reservoir
3. Engine oil filler cap
4. Rockercover
5. Brakebooster
6. Brake fluid reservoir
7. Clutch fluid reservoir (If Installed)
8. Aircleaner
9. Relaybox
10. Windshield washer fluid reservoir cap
11. Engine oil level dipstick
12. Sparkplug

CAUTION:

When inspecting or servicing the engine, you should handle tools and other heavy objects carefully so that the plastic rocker cover of the engine is not damaged.

13. Radiatorcap
14. Automatic transaxle fluid level dipstick (automatic T/A only)
15. Battery

DO-IT-YOURSELF MAINTENANCE

G010C01A-QAT

ENGINE COMPARTMENT (For Carburetor)

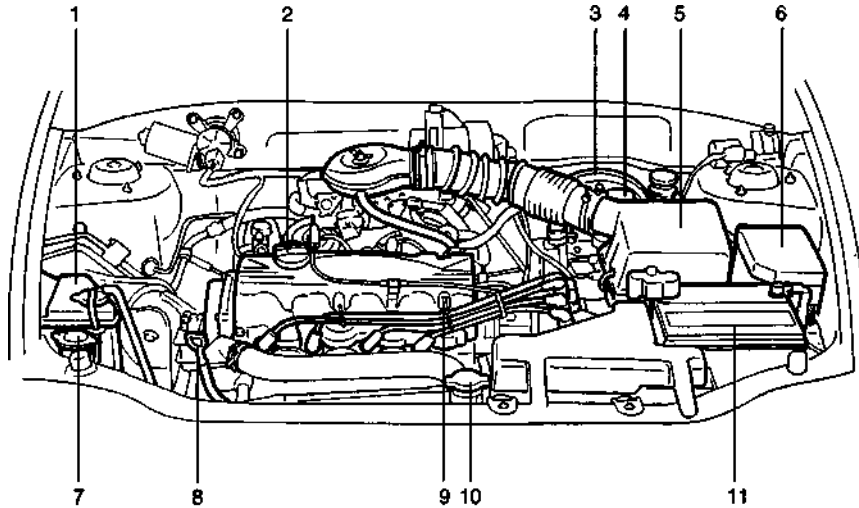

CAUTION:

When inspecting or servicing the engine, you should handle tools and other heavy objects carefully so that the plastic rocker cover of the engine is not damaged.

1. Coolant reservoir
2. Engine oil filler cap
3. Brake booster
4. Brake fluid reservoir

5. Air cleaner
6. Relay box
7. Windshield washer fluid reservoir cap
8. Engine oil level dipstick

9. Spark plug
10. Radiator cap
11. Battery

DO-IT-YOURSELF MAINTENANCE

ENGINE COMPARTMENT (For DOHC)

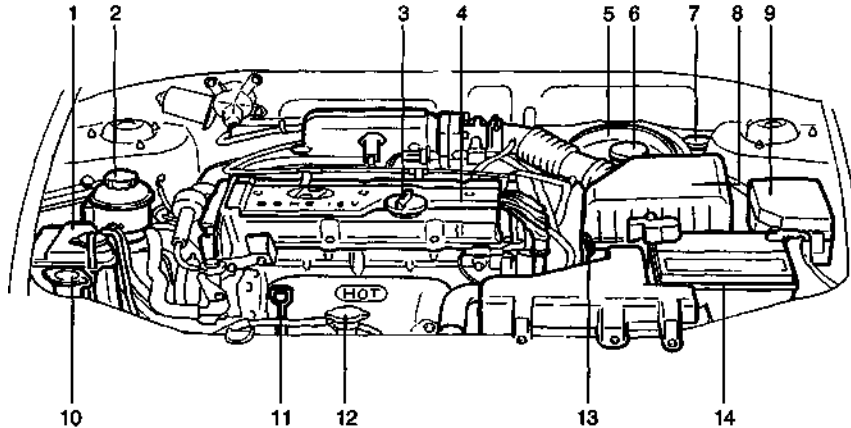

CAUTION:

When inspecting or servicing the engine, you should handle tools and other heavy objects carefully so that the plastic rocker cover of the engine is not damaged.

1. Engine coolant reservoir cap
2. Power steering fluid reservoir
3. Engine oil filler cap
4. Rocker cover
5. Brake booster

6. Brake fluid reservoir
7. Clutch fluid reservoir (if installed)
8. Aircleaner
9. Relaybox
10. Windshield washer fluid reservoir cap

11. Engine oil level dipstick
12. Radiator cap
13. Automatic transxle fluid level dipstick
(Automatic T/A only)
14. Battery

DO-IT-YOURSELF MAINTENANCE

G020A01A-AAT

GENERAL EVERYDAY CHECKS

Engine Compartment

The following should be checked regularly:

- o Engine oil level and condition
- o Transaxle fluid level and condition
- o Brake fluid level
- o Clutch fluid level
- o Engine coolant level
- o Windshield washer fluid level
- o Accessory drive belt condition
- o Engine coolant hose condition
- o Airfilter condition
- o Exhaust system condition
- o Fluid leaks (on or below components)
- o Power steering fluid level and condition
- o Battery Condition

G020B01A-AAT

Vehicle Exterior

The following should be checked monthly:

- o Overall appearance and condition
- o Wheel condition and wheel nut tightness
- o Exhaust system condition
- o Light condition and operation
- o Windshield glass condition
- o Wiper blade condition
- o Paint condition and body corrosion
- o Fluid leaks
- o Door and hood lock condition
- o Tire pressure and condition (including spare tire)

6-4

G020C01A-AAT

Vehicle Interior

The following should be checked each time when the vehicle is driven:

- o Light operation
- o Windshield wiper operation
- o Horn operation
- o Defroster, heater system operation (and air conditioning, if installed)
- o Steering operation and condition
- o Mirror condition and operation
- o Turn signal operation
- o Accelerator pedal operation
- o Brake operation, including parking brake
- o Manual transaxle operation, including clutch operation
- o Automatic transaxle operation, including "Park" mechanism operation
- o Seat control condition and operation
- o Seat belt condition and operation
- o Sun visor operation

If you notice anything that does not operate correctly Or appears to be functioning correctly, inspect it carefully and seek assistance from your Hyundai dealer if service is needed.

G030A01A-AAT

CHECKING THE ENGINE OIL

Engine oil is essential to the performance and service of the engine. It is suggested that you check the oil level at least once a week in normal use and more often if you are on a trip or driving in severe conditions.

S030B01A-GAT

Recommended Oil

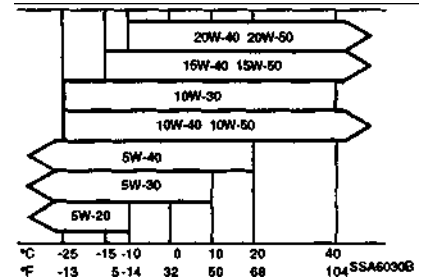

SH, SG or SG/CD (API) multi-grade and fuel efficient oil is recommended.

NOTE:
SAE 5W-20 is not recommended for sustained high speed vehicle operation.

DO-IT-YOURSELF MAINTENANCE

G030C01A-AAT

To Check the Oil Level

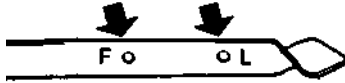

Before checking the oil, warm up the engine to the normal operating temperature and be sure it is parked on level ground. Turn the engine off.

Wait a minute, then remove the dipstick, wipe it off, fully reinsert the dipstick and withdraw it again. Then note the highest level the oil has reached on the dipstick. It should be between the upper ("FULL") and lower ("LOW") range.

G030D01A-GAT

Adding Oil

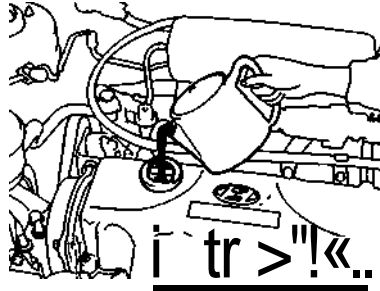

If the oil level is close to or below the "L" mark, add oil until it reaches the "F" mark. To add oil:

1. Remove the oil filler cap by turning it counter-clockwise.
2. Add oil, then check the level again. Do not overfill.
3. Replace the cap by turning it clockwise.

The distance between the "F" and V marks is equal to about 1 liter of oil.

G360A01A-GAT

ENGINE OIL CONSUMPTION

Function of Engine Oil

Engine oil has the primary function of lubricating and cooling the inside of the engine.

Engine oil consumption

It is normal that an engine should consume some engine oil while normal driving. The cause of oil consumption in a normal engine are as follows;

- o Engine oil is used to lubricate pistons, piston rings and cylinders.
- o A thin film of oil is left on the cylinder wall when a piston moves downwards in the cylinder. High negative pressure generated during engine operation sucks some of the oil into the combustion chamber. This oil with some oil of the cylinder wall is burned by the high temperature combustion gases during the combustion process.
- o The engine oil consumption is strongly affected by the viscosity and quality of oil, engine rpm and driving condition etc. The engine oil is more consumed under severe driving conditions such as high speeds and frequent acceleration and deceleration than normal driving condition.

DO-IT-YOURSELF MAINTENANCE

G040A01A-AAT

CHANGING THE OIL AND FILTER

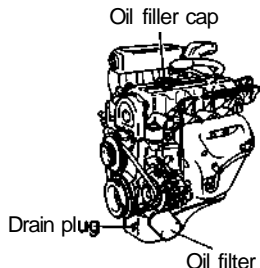

The engine oil and filter should be changed at those intervals specified in the maintenance schedule in Section 5. If the car is being driven in severe conditions, more frequent oil and filter changes are required.

The procedure for changing the oil and filter is as follows:

1. Park the car on level ground and set the parking brake. Start the engine and let it warm up until the needle on the temperature gauge moves above the lowest mark. Turn the engine off and place the gear selector lever in "P" (automatic) or reverse gear (manual transaxle).
2. Open the hood and remove the engine oil filler cap.
3. Slide underneath the car and loosen the drain plug by turning it counterclockwise

with a wrench of the proper size. Be sure that a drain pan is in position to catch the oil as it drains out, then remove the drain plug.

WARNING:

Be very careful when draining the engine oil as it may be hot enough to burn you!

4. When the oil has stopped draining, replace the drain plug using a new washer and re-tighten by turning it clockwise.
5. Remove the oil filter. You should be able to unscrew the filter with your hands. (If your hands are slippery, try using a cloth between your hands and the filter to give yourself a better grip.) A certain amount of oil will come out when you remove the filter so be sure to have your drain pan in place underneath it.
6. Install a new oil filter in accordance with the instructions on the carton or on the filter itself. Do not over-tighten. Be sure that the mounting surface on the engine is clean and that the old gasket is removed completely. Lubricate the new gasket on the filter before installation with clean engine oil.
7. Refill the crankcase with the recommended engine oil. Refer to the specification in chapter 9 for engine oil capacity.
8. Start the engine and check to be sure no oil is leaking from the drain plug or oil filter.
9. Shut off the engine and recheck the oil level.

NOTE:

Always dispose of used engine oil in an environmentally acceptable manner. It is suggested that it be placed in a sealed container and taken to a service station for reclamation. Do not pour the oil on the ground or put it into the with household trash.

WARNING:

Used motor oil may cause Irritation or cancer of the skin if left in contact with the skin for prolonged periods of time. Wash your hands thoroughly with soap and warm water as soon as possible after handling used oil.

ZG060A1-A

CHECKING AND CHANGING THE ENGINE COOLANT

WARNING:

Do not remove the radiator cap when the engine is hot. When the engine is hot, the coolant is under pressure and may erupt through the opening if the cap is removed. You could be seriously burned if you do not observe this precaution. Do not remove the cap until the radiator is cool to the touch.

DO-IT-YOURSELF MAINTENANCE

G050B01A-AAT

Recommended Engine Coolant

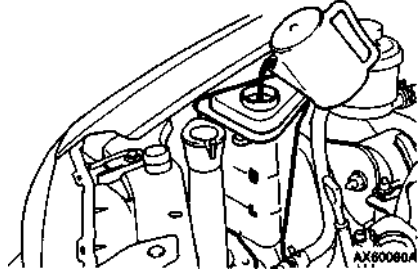

Use a high quality ethylene-glycol coolant in a 50/50 mix with water. The engine coolant should be compatible with aluminum engine parts. Additional corrosion inhibitors or additives should not be used. The cooling system must be maintained with the correct concentration and type of engine coolant to prevent freezing and corrosion.

Never allow the concentration of antifreeze to exceed the 60% level or go below the 35% level or damage to the coolant system may result. For proper concentration when adding or replacing the coolant, refer to the following table.

Ambient temperature °C(°F)	Coolant concentration	
	Antifreeze solution	Water
-15(5)	35%	65%
-25 (-13)	40%	60%
-35 (-31)	50%	50%
-45 (-49)	60%	40%

G050C01A-AAT

To Check the Coolant Level

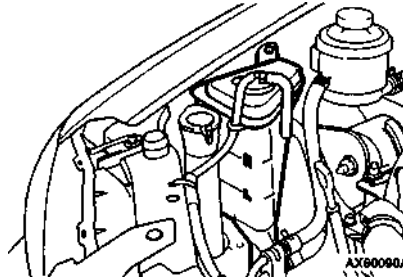

The coolant level can be seen on the side of the plastic coolant reservoir. The level of the coolant should be between the "LOW" and "HIGH" lines on the reservoir when the engine is cool. If the level is below the "LOW" mark, add engine coolant to bring it up between "LOW" and "HIGH". If the level is low, inspect for coolant leaks and recheck the fluid level fre-

quently. If the level drops again, visit your Hyundai dealer for an inspection and diagnosis of the reason.

G050D01A-AAT

To Change the Engine Coolant

The engine coolant should be changed at those intervals specified in the vehicle maintenance schedule in Section 5.

CAUTION:

Engine coolant can damage the finish of your car. If you spill engine coolant on the car, wash it off thoroughly with clean water.

1. Park the car on level ground, set the parking brake and remove the radiator cap when cool.
2. Be sure your drain receptacle is in place. Open the drain cock on the radiator. Allow all the engine coolant to drain from the cooling system, then securely close the drain cock.
3. Check Section 9 for the capacity of the cooling system in your car. Then, following the manufacturer's directions on the engine coolant container, add the appropriate quantity of engine coolant to the radiator. Now fill the radiator with clean demineralized or distilled water. Continue to add demineralized or distilled water in small quantities until the fluid level stays up in the radiator neck.
4. Start the engine, top off the radiator with water and then add engine coolant to the

DO-IT-YOURSELF MAINTENANCE

reservoir until the level is between "LOW" and "FULL".

5. Replace the radiator and reservoir caps and check to be sure the drain cocks are fully closed and not leaking.

WARNING:

The cooling fan is controlled by engine coolant temperature and may sometimes operate even when the engine is not running. Use extreme caution when working near the blades of the cooling fan so that you are not injured by a rotating fan blade. As the engine coolant temperature decreases, the fan will automatically shut off. This is a normal condition.

Q060B02A-GAT

REPLACING THE SPARK PLUGS

Unleaded: 1.0 - 1.1 mm (0.039 - 0.043 in.)

Leaded: 0.7 - 0.8 mm (0.028 - 0.032 in.)

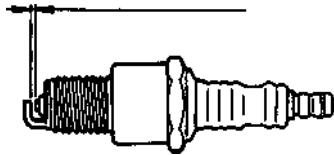

The spark plugs should be changed at the intervals specified in the vehicle maintenance 6-8

schedule in Section 5 or whenever engine performance indicates they should be changed. Symptoms that suggest poor spark plug performance include engine misfiring, underload, loss of fuel economy, poor acceleration, etc. When spark plugs are replaced, always use spark plugs recommended by Hyundai. The use of other spark plugs can result in loss of performance, radio interference or engine damage.

Recommended Spark Plugs:

	Unleaded	Leaded
NGK	BKR5ES-11	BKR5ES
CHAMPION	RC10YC4	RC10YC

G060C01S-QAT

Changing the Spark Plugs

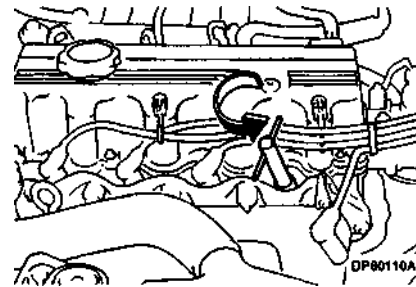

You will find it easier to change spark plugs if the engine is cold. Always change one spark

plug at a time. This helps avoid getting the wires mixed up.

1. Remove the center cover on the engine rocker cover (DOHC Only).
2. Using a clean cloth, remove any dirt that has accumulated around the spark plug so it cannot fall into the cylinder when the spark plug is removed.
3. To remove the spark plug, pull straight up on the insulated connector, not the cable. Pulling on the cable may damage the carbon core conductor.



WARNING:

It is recommended that the engine be cool or cold when changing the spark plugs. If the engine is hot, you could burn yourself on the insulated connector, the spark plug or the engine itself.

DO-IT-YOURSELF MAINTENANCE

- When preparing to remove the old spark plug, guide the socket down over the spark plug, being careful not to damage the ceramic insulator.
- To remove the spark plug, turn the wrench handle in a counterclockwise direction.
- To install the new spark plug, guide the socket down over the spark plug, being careful not to damage the ceramic insulator.



NOTE:

Spark plugs should be tightened firmly. Overtightening can damage the threads in the aluminum cylinder head. Leaving them too loose can cause the spark plug to get very hot and possibly result in damage to the engine.

- Replace the cable by pushing the insulated connector directly down onto the electrode. Check to be sure it has snapped into place and can't fall off.

Q070A02Y-AAT

CHANGING THE AIR CLEANER FILTER

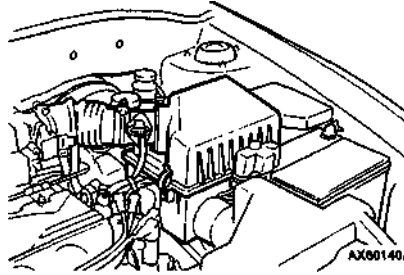

The replacement of air cleaner filter is performed in the following manner.

- Unsnap the Clips around the cover.
- When this is done, the cover can be lifted off, the old filter removed and the new filter put in its place.

Genuine Hyundai replacement parts are recommended.

CAUTION:

Operating your vehicle without a proper air filter in place can result in excessive engine wear.

G080A01A-AAT

WINDSHIELD WIPER BLADES



The wiper blades should be carefully inspected from time to time and cleaned to remove accumulations of road film or other debris. To clean the wiper blades and arms, use a clean sponge or cloth with a mild soap or detergent and water. If the wipers continue to streak or smear the glass, replace them with genuine Hyundai replacement parts or their equivalent.

CAUTION:

Do not operate the wipers on dry glass. This can result in more rapid wear of the wiper blades and may scratch the glass.

DO-IT-YOURSELF MAINTENANCE

G090A01A-GAT

FILLING THE WASHER RESERVOIR

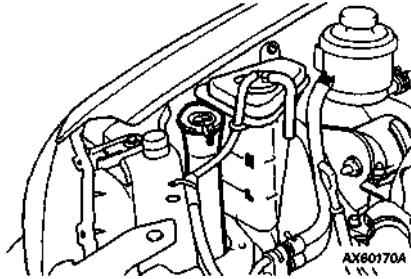

The washer fluid reservoir supplies fluid to the windshield washer system.

A good quality washer fluid should be used to fill the washer reservoir. The fluid level should be checked more frequently during bad weather or whenever the washer system is in more frequent use.

The capacity of the washer reservoir is 3.0 liters (3.2 U.S. quarts).

CAUTION:

- Radiator antifreeze (engine coolant) should not be used in the washer system because it will damage the car's finish.
- The washer lever should not be pulled and the washer should not be operated if the washer reservoir is empty. This can damage the washer fluid pump.

G100A02A-QAT

CHECKING THE TRANSAXLE OIL (MANUAL)

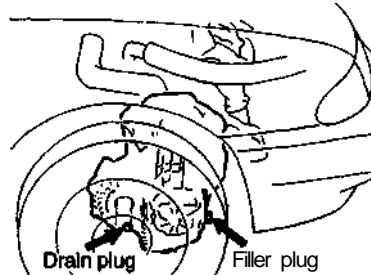

Transaxle lubricant in the manual transaxle should be checked at those intervals specified in the vehicle maintenance schedule in Section 5.

Recommended Oil

Use only API GL-4, SAE 75W/90 in the manual transaxle.

Manual Transaxle Oil Capacity

The oil capacity of the manual transaxle is 2.15 liters (2.27 U.S. quarts).

WARNING:

It is always better to check the transaxle oil level when the engine is cool or cold. If the engine is hot, you should exercise great caution to avoid burning yourself on hot engine or exhaust parts.

Q100B01A-AAAT

To check the Transaxle Fluid Level

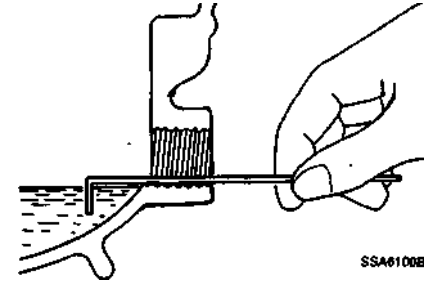

Park the car on level ground with the engine off.

1. Using a wrench of the correct size, loosen the oil filler plug by turning it counterclockwise and remove it with your fingers.
2. Use your finger or suitable tool to feel inside the hole. The oil level should be at its bottom edge. If it is not, check for leaks before adding oil. To refill the transaxle or bring the oil level up, add oil slowly until it reaches the proper level. Do not overfill.
3. Replace the plug, screw it in with your fingers and then tighten securely with the wrench.

DO-IT-YOURSELF MAINTENANCE

G110A01A-AAT

CHECKING THE TRANSAXLE FLUID (AUTOMATIC)

Transaxle fluid in the automatic transaxle should be checked at those intervals specified in the vehicle maintenance schedule in Section 5.

G110B02A-AAT

Recommended Fluid

Your Hyundai automatic transaxle is specially designed to operate with HYUNDAI ATF SP-II M or GENUINE DIAMOND ATF SP-II M. Damage caused by a nonspecified fluid is not covered by your new vehicle limited warranty.

G110C02A-GAT

Transaxle Fluid Capacity

The fluid capacity of the automatic transaxle is 6.1 liters (6.45 U.S. quarts).

WARNING:

The transaxle fluid level should be checked when the engine is at normal operating temperature. This means that the engine, radiator, exhaust system etc., are very hot. Exercise great care not to burn yourself during this procedure.

Q110001A-GAT

To Check the Transaxle Fluid Level

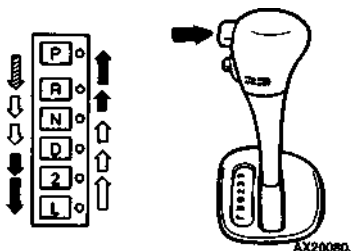

Park the car on level ground with the parking brake engaged. When the transaxle fluid level is checked, the transaxle fluid should be at normal operating temperature and the engine idling.

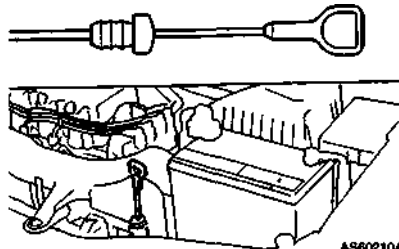

While the engine is idling, apply the brakes and move the gear selector lever from "P" to each of its other positions — "R", "N", "D", "2", "L" — and then return to "N". With the engine still idling:

1. Open the hood, being careful to keep hands, long hair and clothing clear of any moving parts.
2. Remove the transaxle dipstick, wipe it clean, reinsert the dipstick as far as it will go, then remove it again. Now check the fluid level on the dipstick. It should be in the "HOT" range on the dipstick.

Fluid level should be within this range

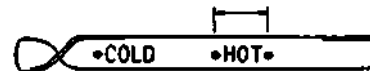

3. If the transaxle fluid level is low, use a funnel to add transaxle fluid through the dipstick tube until the level reaches the "HOT" range. Do not overfill.

DO-IT-YOURSELF MAINTENANCE

WARNING:

The cooling fan is controlled by engine coolant temperature and may sometimes operate even when the engine is not running. Use extreme caution when working near the blades of the cooling fan, so that you are not injured by a rotating fan blade. As the engine coolant temperature decreases, the fan will automatically shut off. This is a normal condition.

G120A01A-AAT

CHECKING THE BRAKES

CAUTION:

Because brakes are essential to the safe operation of the car, it is suggested that they be checked and inspected by your Hyundai dealer. The brakes should be checked and inspected for wear at those intervals specified in the vehicle maintenance schedule in Section 5.

G120B01A-AAT

Checking the Brake Fluid Level

WARNING:

Use caution when handling brake fluid. It can damage your vision if it gets into your eyes. It will also damage your vehicle's paint if spilled on it and not removed immediately.

G120C01A-AAT

Recommended Brake Fluid

Use only hydraulic brake fluid conforming to DOT 3 specifications in your braking system. Follow the instructions printed on the container.

G120D01A-AAT

To Check the Fluid Level

The fluid level in the brake fluid reservoir should be checked periodically. The level should be between the "MIN" and "MAX" marks on the side of the reservoir. If the level is at or below the "MIN" mark, carefully add fluid to bring it up to "MAX". Do not overfill.

Q120E01A-AAT

Adding Brake Fluid

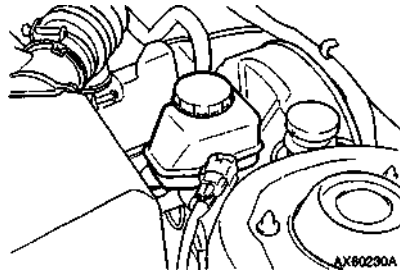

WARNING:

Handle brake fluid carefully. It can damage your vision if it gets into your eyes. Use only DOT 3 specification fluid from a sealed container. Do not allow the fluid can or reservoir to remain open any longer than required. This will avoid entry of dirt and moisture which can damage the brake system and cause improper operation.

To add brake fluid, first wipe away any dirt then unscrew the fluid reservoir cap. Slowly pour the recommended fluid into the reservoir. Do not overfill. Carefully replace the cap on the reservoir and tighten.

G130A01A-AAT

CHECKING THE CLUTCH FLUID

To Check the Clutch Fluid

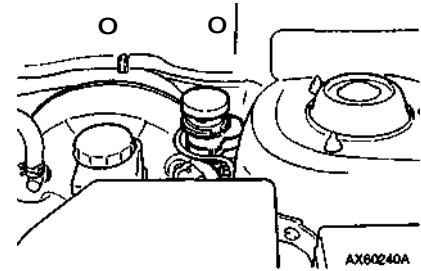

The clutch fluid level in the master cylinder should be checked when performing other under hood services. The system should be checked for leakage at the same time. Check to make certain that the clutch fluid level is between the "MAX" and "MIN" level markings on the fluid reservoir. Fill as required. Fluid loss indicates a leak in the clutch system which should be inspected and repaired immediately. Consult your Hyundai dealer.

DO-IT-YOURSELF MAINTENANCE

G130B01A-AAT

To Replace the Fluid

Recommended brake fluid conforming to DOT 3 specification should be used. The reservoir cap must be fully tightened to avoid contamination from foreign matter or moisture.

NOTE:

Do not allow any other liquids to contaminate the brake fluid. Seal damage will result.

WARNING:

Use caution when handling brake fluid. It can damage your vision if you get it in your eyes. It will also damage your vehicles paint if spilled on it and not removed immediately.

G140A01A-AAT

AIR CONDITIONER CARE

Keeping the Condenser Clean

The air conditioner condenser (and engine radiator) should be checked periodically for accumulation of dirt, dead insects, leaves, etc. These can interfere with maximum cooling efficiency. When removing such accumulations, brush or hose them away carefully to avoid bending the cooling fans.

G140D01S-QAT

Checking the Compressor Drive Belt

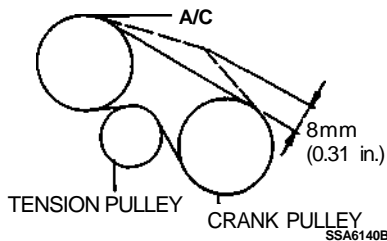

When the airconditioning is being used regularly, the compressor drive belt tension should be checked at least once a month.

To check the drive belt tension, press down on the belt halfway between the engine crankshaft and compressor pulleys. Pressing with your finger, you should not be able to deflect this belt anymore than 8.0 mm. If you have the instruments to check it with a force of 98N (22 lb.), the deflection should be approx. 8.0 mm (0.315 inches). If the belt is too loose, have it adjusted by your Hyundai dealer.

Q140B01A-AAT

Checking the Air Conditioner Operation

1. Start the engine and let it run at fast idle for several minutes with the air conditioner set at the maximum cold setting.

2. If the air coming out of the in-dash vents is not cold, have the air conditioning system inspected by your Hyundai dealer.

CAUTION:

Running the air conditioning system for extended periods of time with a low refrigerant level may damage the compressor.

G140C01A-AAT

Lubrication

To lubricate the compressor and the seals in the system, the air conditioner should be run for at least 10 minutes each week. This is particularly important during cool weather when the air conditioning system is not otherwise in use.

Q150A01A-QAT

CHECKING STEERING WHEEL FREEPLAY

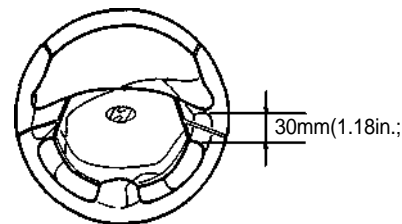

DO-IT-YOURSELF MAINTENANCE

To check the steering wheel freeplay, stop the car with the wheels pointed straight ahead and gently move the steering wheel back and forth. Use very light finger pressure and be sensitive to changes in resistance that mark the limits of the freeplay. If the freeplay is greater than specified, have it inspected by your Hyundai dealer and adjusted or repaired if necessary.

Q160A01A-3AT

CHECKING CLUTCH PEDAL FREEPLAY

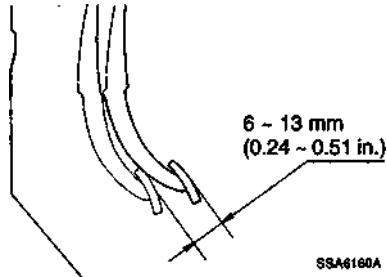

With the engine off, press lightly on the clutch pedal until you feel a change in resistance. This is the clutch pedal freeplay. The freeplay should be within the limits specified in the illustration. If it is not, have it inspected by your Hyundai dealer and adjusted or repaired if necessary.

G170A01A-QAT

CHECKING BRAKE PEDAL FREEPLAY

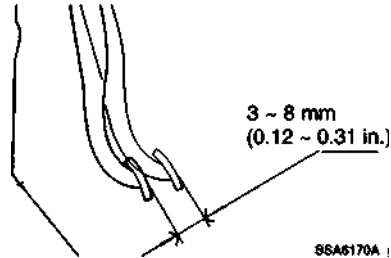

With the engine off, press down on the brake pedal several times to reduce the vacuum in the brake booster.

Then, using your hand, press down slowly on the brake pedal until you feel a change in resistance. This is the brake pedal freeplay. The freeplay should be within the limits specified in the illustration. If it is not, have it inspected by your Hyundai dealer and adjusted or repaired if necessary.

Q180A01A-GAT

CHECKING BRAKE PEDAL CLEARANCE

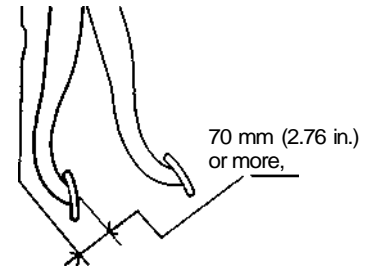

You need a helper to check the brake pedal clearance. With the engine running, have your helper press down on the brake pedal several times and then hold it down with a force of about 50 kg (490 N). The brake pedal clearance is the distance from the top surface of the brake pedal to the asphalt sheeting under the floor mat. If the brake pedal clearance is not within the limits specified in the illustration, have it inspected by your Hyundai dealer and adjusted or repaired if necessary.

DO-IT-YOURSELF MAINTENANCE

G190A01A-GAT

CHECKING DRIVE BELTS

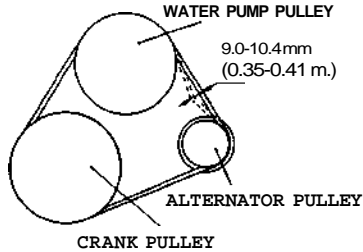

Drive belts should be checked periodically for proper tension and adjusted if necessary. At the same time, belts should be examined for cracks, wear, fraying or other evidence of deterioration and replaced if necessary.

Belt routing should also be checked to be sure there is no interference between the belts and other parts of the engine. After a belt is replaced, the new belt should be adjusted again after two or three weeks to eliminate slack resulting from initial stretching after use.

G200A01A AAT

CHECKING AND REPLACING FUSES

Replacing a Fusible Link

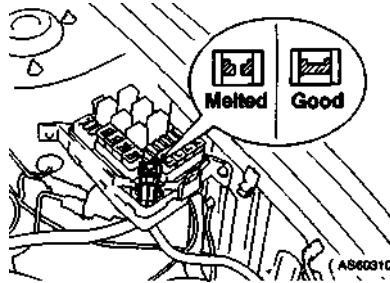

A fusible link will melt if the electrical circuits from the battery are ever overloaded, thus preventing damage to the entire wiring harness. (This could be caused by a short in the system drawing too much current.) If this ever happens, have a Hyundai dealer determine the cause, repair the system and replace the fusible link. The fusible links are located in a relay box for easy inspection.

CAUTION:

When replacing a fusible link, never use anything but a new fusible link with the same or lower amperage rating. Never use a piece of wire or a higher-rated fusible link. This could result in serious damage and create a fire hazard.

G200601A-AAT

Replacing Accessory Fuse

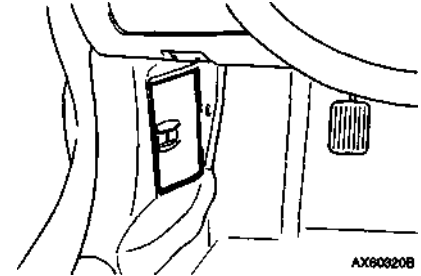

The fuse box for the lights and other electrical accessories will be found low on the dashboard on the driver's side. Inside the box you will find a list showing the circuits protected by each fuse.

If any of your car's lights or other electrical accessories stop working, a blown fuse could be the reason. If the fuse has burned out, you will see that the metal strip inside the fuse has burned through. If you suspect a blown fuse, follow this procedure:

1. Turn off the ignition and all other switches.
2. Open the fuse box and examine each fuse. Remove each fuse by pulling it toward you (a small "fuse puller" tool is contained in the fuse box to simplify this operation).
3. Be sure to check all other fuses even if you find one that appears to have burned out.

DO-IT-YOURSELF MAINTENANCE

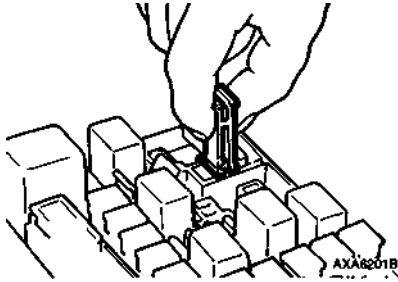

4. Replace the blown fuse by pressing a new fuse of the same rating into place. The fuse should be a snug fit. If it is not, have the fuse clip repaired or replaced by a Hyundai dealer. If you do not have a spare fuse, you may be able to borrow a fuse of the same or lower rating from an accessory you can temporarily get along without (the radio or cigarette lighter, for example). Always remember to replace the borrowed fuse.

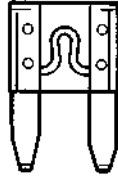

Good

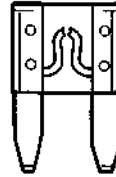

Burned out

G200603Y

CAUTION:

A burned-out fuse indicates that there is a problem in the electrical circuit. If you replace a fuse and it blows as soon as the accessory is turned on, the problem is serious and should be referred to a Hyundai dealer for diagnosis and repair. Never replace a fuse with anything except a fuse with the same or a lower amperage rating. A higher capacity fuse could cause damage and create a fire hazard.

G210A01A-AAT

CHECKING THE BATTERY

WARNING:

When working with batteries, carefully observe the following precautions to avoid serious injuries.

The fluid in the battery contains a strong solution of sulfuric acid, which is poisonous and highly corrosive. Be careful not to spill it on yourself or the car. If you do spill battery fluid on yourself, immediately do the following:

- o If battery fluid is on your skin, flush the affected areas with water for at least 15 minutes and then seek medical assistance.
- o If battery fluid is in your eyes, rinse out your eyes with water and get medical assistance as soon as possible. While you are being driven to get medical assistance, continue to rinse your eyes by using a sponge or soft cloth saturated with water.
- o If you swallow battery fluid, drink a large quantity of water or milk followed by milk of magnesia, eat a raw egg or drink vegetable oil. Get medical assistance as soon as possible.

While batteries are being charged (either by a battery charger or by the vehicle's alternator), they produce explosive gases. Always observe these warnings to prevent injuries from occurring:

DO-IT-YOURSELF MAINTENANCE

- o Charge batteries only in a well ventilated area.
- o Do not permit flames, sparks or smoking in the area.
- o Keep children away from the area.

G210B01A-AAT

Checking the Battery

Keep the battery clean. Any evidence of corrosion around the battery posts or terminals should be removed using a solution of household baking soda and warm water. After the battery terminals are dry, cover them with a light coating of grease.

G220A01A-AAT

CHECKING ELECTRIC COOLING FANS

WARNING:

The radiator fan is controlled by engine coolant temperature and may sometimes operate even when the engine is not running. Use extreme caution when working near the blades of the cooling fan, so that you are not injured by a rotating fan blade. As the coolant temperature decreases the fan will automatically shut off. This is a normal condition.

G220B01A-AAT

Checking Engine Cooling Fan

The engine cooling fan should come on automatically if the engine coolant temperature is high.

G220C01A-AAT

Checking Condenser Cooling Fan

The condenser cooling fan should come on automatically whenever the air conditioner is in operation.

G230A03A-OAT

POWER STEERING FLUID LEVEL

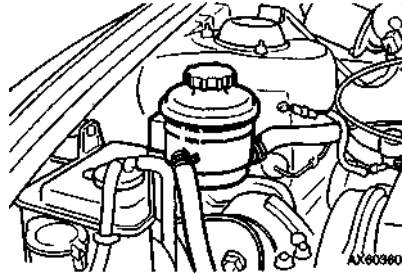

The power steering fluid level should be checked daily.

To check the power steering fluid level, be sure the ignition is "OFF", then check to make certain that the power steering fluid level is between the "MAX" and "MIN" level markings on the fluid reservoir.

NOTE:

Grinding noise from the power steering pump may be heard immediately after the engine is started in extremely cold conditions

below -20°C). In this case, if the noise stops during warm up, there is no abnormal function in the system. This is due to a power steering fluid characteristic in extremely cold conditions.

Recommended Fluid

Use PSF-3 type fluid.

NOTE:

Do not start the engine when the power steering oil reservoir is empty.

G240A01A-AAT

POWER STEERING HOSES

It is suggested that you check the power steering hose connections for fluid leakage at those intervals specified in the vehicle maintenance schedule in Section 5.

The power steering hoses should be replaced if there is severe surface cracking, pulling, scuffing or worn spots. Deterioration of the hose could cause premature failure.

G260A01A-AAT

REPLACING LIGHT BULBS

Before attempting to replace a light bulb, be sure the switch is turned to the "OFF" position. The drawing in the next paragraph shows how to reach light bulbs so they may be changed. Be sure to replace the burned-out bulb with one of the same number and wattage rating.

DO-IT-YOURSELF MAINTENANCE

G270A02A-QAT

HEADLIGHT BULB

Replacement instructions:

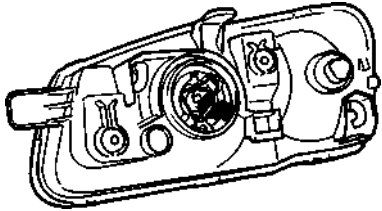

1. Allow the bulb to cool. Wear eye protection.
2. Always grasp the bulb by its plastic base, avoid touching the glass.
3. Disconnect the power cord from the bulb base in the back of the headlight.
4. Remove the dust cover.
5. Push the bulb spring for removing the headlight bulb.
6. Remove the protective cap from the replacement bulb and install the new bulb by matching the plastic base with the headlight hole. Install the dust cover after retightening the bulb spring and reconnect the power cord.
7. Use the protective cap and carton to dispose of the old bulb.
8. Check for proper headlight aim.

WARNING

This halogen bulb contains gas under pressure and if impacted could shatter, resulting in flying fragments. Always wear eye protection when servicing the bulb. Protect the bulb against abrasions or scratches and against liquids when lighted. Turn on the bulb only when installed in a headlight. Replace the headlight if damaged or cracked. Keep the bulb out of the reach of children and dispose of the used bulb with care.

G290A01A-GAT

HEADLIGHT AIMING ADJUSTMENT

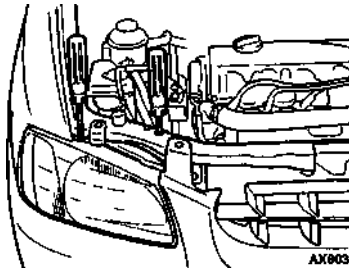

Before performing aiming adjustment, make sure of the following.

1. Keep all tires inflated to the correct pressure.
2. Place the vehicle on level ground and press the front bumper & rear bumper down several times.

3. See that the vehicle is unloaded (except for full levels of coolant, engine oil and fuel, and spare tire, jack, and tools).
4. Clean the head lights lens and turn on the headlight (Low beam).
5. Open the hood.
6. Draw the vertical line (through the center of each headlight) and the horizontal line (through the center of each headlight) on the aiming screen.
 - 1) Horizontal line dimension from ground: 627 mm (24.68 in.)
 - 2) Distance between each vertical line: 1,080mm (42.52 in.)

And then, draw the parallel line at 30 mm (1.18 in.) place under the horizontal line.

7. Adjust each cut-off line of the low beam to the parallel line with a phillips screwdriver - **VERTICAL AIMING**
8. Adjust each cut-off line of the low beam to the each vertical line with a phillips screwdriver - **HORIZONTAL AIMING.**

DO-IT-YOURSELF MAINTENANCE

G290B01A-GAT

Adjustment After Headlight Assembly Replacement

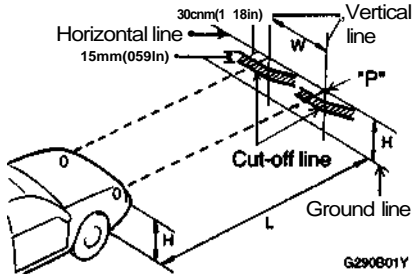

If the vehicle has had front body repair and the headlight assembly has been replaced, the headlight aiming should be checked using the aiming screen as shown in the illustration. Turn on the headlight switch. (Low Beam Position)

1. Adjust headlights so that main axis of light is parallel to center line of the body and is aligned with point "P" shown in the illustration.
2. Dotted lines in the illustration show center of headlights.

•H";

Horizontal center line of headlights from ground : 627 mm (24.68 in.)

•W";

Distance between each headlight center:

1,080mm (42.52 in.)

∇;

Distance between the headlights and the wall that the lights are tested against. 3,000 mm (118.11 in.).

DO-IT-YOURSELF MAINTENANCE

G280A02A-GAT

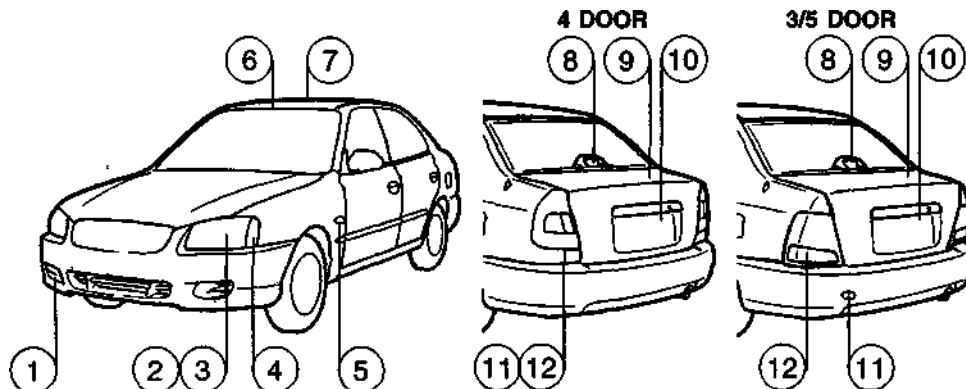

No.	Part Name	Wattage	No.	Part Name	Wattage			
1	Front Fog Light (If installed)	27	9	Luggage Compartment Light	5			
2	Headlight	60/55	10	License Plate Light	5			
3	Front Position Light	5	11	Rear Fog Light (If installed)	21			
4	Front Turn Signal Light	21	12	Rear Combination Light	4DOOR	3/5DOOR		
5	Side Repeater Light (If installed)	5				Except E.C	E.C Only	
6	Interior Light (With sunroof)	10			Turn Signal Light	21	27	21
7	Interior Light (Without sunroof)	10			Stop/Tail Light	21/5	27/8	21/5
8	High Mounted Rear Stop Light (If installed)	17(Except E.C) 16(E.C.Only)		Back-up Light	21	27	21	

EMISSION CONTROL SYSTEM

ZH000A1-A

7. EMISSION CONTROL SYSTEM

H010A01A-GAT

EMISSION CONTROL SYSTEM

(If Installed)

Your Hyundai is equipped with an emission control system to meet all requirements of the Emission prohibition rules of your province. There are three emission control systems which are as follows.

- 1) Crankcase emission control system
- 2) Evaporative emission control system
- 3) Exhaust emission control system

In order to assure the proper function of the emission control systems, it is recommended that you have your car inspected and maintained by an authorized Hyundai dealer in accordance with the maintenance schedule in this manual.

H010B01A-AAT

1. CRANKCASE EMISSION CONTROL SYSTEM

The positive crankcase ventilation system is employed to prevent air pollution caused by blow-by gases being emitted from the crankcase. This system supplies fresh air to the

crankcase through the air cleaner. Inside the crankcase, the fresh air mixes with blow-by gases, then passes through the PCV valve into the induction system.

H010C02A-GAT

2. EVAPORATIVE EMISSION CONTROL SYSTEM (If installed)

The Evaporative Emission Control System is designed to prevent fuel vapors from escaping into the atmosphere.

Canister

While the engine is inoperative, fuel vapors generated inside the fuel tank are absorbed and stored in the canister. When the engine is running, the fuel vapors absorbed in the canister are drawn into the induction system through the purge control solenoid valve.

Purge Control Solenoid Valve

The purge control solenoid valve is controlled by the ECM; when the engine coolant temperature is low, and during idling, it closes, so that evaporated fuel is not taken into the surge tank. After engine warm-up, during ordinary driving, it opens so as to introduce evaporated fuel to the surge tank.

H010001A-AAT

3. Exhaust Emission Control System

The exhaust emission control system is a highly effective system which controls exhaust emission while maintaining good vehicle performance.

H020A01A-GAT

CATALYTIC CONVERTER (If Installed)

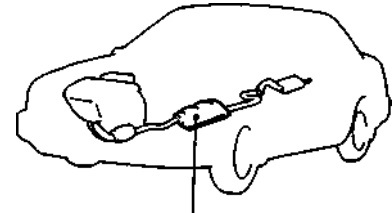

Catalytic Converter

The catalytic converter is part of the exhaust emission control system. Its purpose is to remove certain engine emission products from the engine's exhaust. It looks something like a muffler and is located underneath the car in the exhaust system.

EMISSION CONTROL SYSTEM

H020B01A-GAT

About the Catalytic Converter

Exhaust gases passing through the catalytic converter cause it to operate at very high temperatures. As a result, the introduction of large amounts of unburned gasoline may cause it to overheat and create a fire hazard.

This can be avoided by observing the following:

- o Use unleaded fuel only.
- o Maintain your engine in good condition. Extremely high converter temperatures can result from improper operation of the electrical, ignition or fuel injection systems.
- o If your engine stalls, pings, knocks, or is hard to start, take your car to your Hyundai dealer as soon as possible and have the difficulty corrected.
- o Avoid driving with a very low fuel level. If you run out of gasoline, it could cause the engine to misfire and result in excessive loading of the catalytic converter.
- o Avoid idling the engine for periods longer than 10 minutes.
- o Your Hyundai should not be either pushed or pulled to get it started.
This can cause the catalytic converter to overload.
- o Take care not to stop your Hyundai over any combustible material such as grass, paper, leaves or rags. As these materials could come in contact with the catalytic converter and could cause a fire.

Do not touch the catalytic converter or any other part of the exhaust system while the engine is running as it is very hot and could result in burns.

Remember that your Hyundai dealer is your best source of assistance.

8. THINGS YOU SHOULD KNOW Consumer Information

I010A01A-GAT VEHICLE IDENTIFICATION NUMBER (VIN)

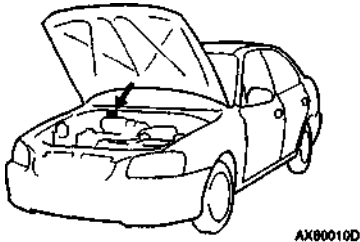

The vehicle identification number (VIN) is the number used in registering your car and in all legal matters pertaining to its ownership, etc. It can be found on the identification plate attached to the engine side of the firewall between the engine and passenger compartment.

CONSUMER INFORMATION

I010B01A-AAT Engine Number

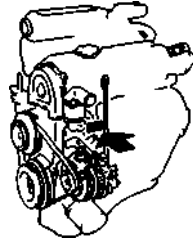

DP80020A

The engine number is stamped on the engine block as shown in the drawing.

I020A01A-AAT TIRE INFORMATION

The tires supplied on your new Hyundai are chosen to provide the best performance for normal driving.

I030A01A-AAT RECOMMENDED INFLATION PRESSURES

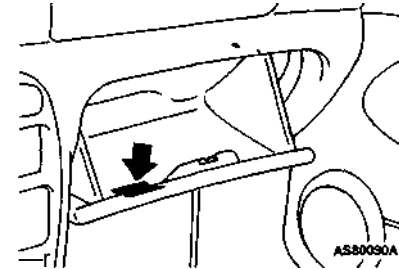

The tire label located in the glove box gives the tire pressures recommended for your car. These pressures were chosen to provide the most satisfactory combination of ride comfort, tire wear and stability under normal conditions. Tire pressures should be checked at least monthly. Proper tire inflation pressures should be maintained for these reasons:

- o Lower-than-recommended tire pressures cause uneven tread wear and poor handling.
- o Higher-than-recommended tire pressures increase the chance of damage from impacts and cause uneven tread wear.

CONSUMER INFORMATION

CAUTION:

Always observe the following:

- o Check pressures when the tires are cold. That is, after the car has been parked for at least three hours and hasn't been driven more than one mile or 1.6 km since starting up.
- o Check the pressure of your spare tire each time you check the pressure of other tires.
- o Never overload your car. Be especially careful about overloading if you equip your car with a luggage rack or car top carrier.

I040A01A-QAT

SNOW TIRES

If you equip your car with snow tires, they should be the same size and have the same load capacity as the original tires. Snow tires should be installed on all four wheels; otherwise, poor handling may result.

Snow tires should carry 4 psi (28 kPa) more air pressure than the pressure recommended for the standard tires on the tire label on the glove box, or up to the maximum pressure shown on the tire sidewall whichever is less.

Do not drive faster than the speed limit when your car is equipped with snow tires.

I050A02A-QAT

TIRE CHAINS

Tire chains should be installed on the front wheels. Be sure that the chains are the proper size and that they are installed in accordance with the manufacturer's instructions.

To minimize tire and chain wear, do not continue to use tire chains when they are no longer needed.

WARNING:

When driving on roads covered with snow or ice, drive at less than 30 km/h (20 mph).

I060A01A-GAT

TIRE ROTATION

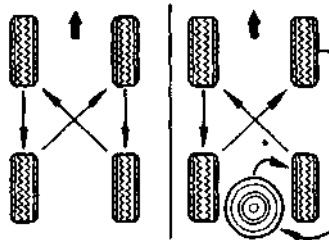

Tires should be rotated every 10,000 km (6,000 miles). If you notice that tires are wearing unevenly between rotations, have the car checked by a Hyundai dealer so the cause may be corrected.

After rotating, adjust the tire pressures and be sure to check wheel nut tightness.

WARNING:

Do not mix bias-ply and radial-ply under any circumstances.

This may cause dangerous handling characteristics.

TIRE BALANCING

A tire that is out of balance may affect handling and tire wear. The tires on your Hyundai were balanced before the car was delivered but may need balancing again during the years you own the car.

Whenever a tire is dismantled for repair, it should be rebalanced before being reinstalled on the car.

I080A01A-AAT

TIRE TRACTION

Tire traction can be reduced if you drive on worn tires, tires that are improperly inflated or on slippery road surfaces. Tires should be replaced when tread wear indicators appear. To reduce the possibility of losing control, slow down whenever there is rain, snow or ice on the road.

1090A01S-GAT

WHEN TO REPLACE TIRES

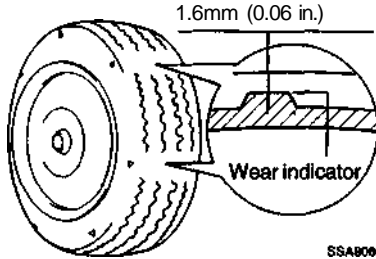

WARNING:

- o Driving on worn-out tires is dangerous! Worn-out tires can cause loss of braking effectiveness, steering control and traction. When replacing tires, never mix radial and bias-ply tires on the same car. If you replace radial tires with bias-ply tires, they must be installed in sets of four.
- o Using tires and wheels of other than the recommended sizes may cause unusual handling characteristics that may cause death, serious injury or property damage.

The original tires on your car have tread wear indicators. The tread wear indicators appear when the tread depth is 1.6 mm (0.06 in.). The tire should be replaced when these appear as a

CONSUMER INFORMATION

solid bar across two or more grooves of the tread. Always replace your tires with those of the recommended size. If you change wheels, the new wheel's rim width and offset must meet Hyundai specification.

MO0A01A-AAT

SPARE TIRE AND TOOLS

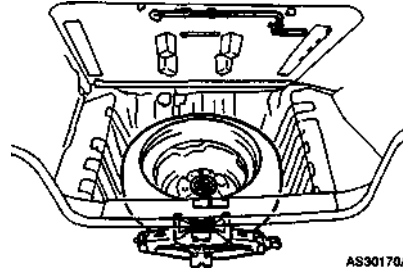

Your Hyundai is delivered with the following:

Spare tire
Wrench
Jack
Jack handle

VEHICLE SPECIFICATIONS

9. VEHICLE SPECIFICATIONS

J010A01A-GAT

MEASUREMENT

mm (in.)

		4DR	3/5 DR
Overall length		4,235(166.7)	4,200(165.4)
Overall width		1,670(65.7)	1,670(65.7)
Overall height (unladen)		1,395(54.9)	1,395(54.9)
Wheel base		2,400(94.5)	2,400(94.5)
Wheel tread	Front	1,435(56.5)	1,435(56.5)
	Rear	1,425(56.1)	1,425(56.1)

J020A01A-GAT

POWER STEERING

Type	Rack and pinion
Wheel free play	0-30 mm (0-1.18in)
Rack stroke	134mm (5.3 in.)
Oil pump type	Vanetype

J060A01A-GAT

FUEL SYSTEM

Fuel tank capacity	Liter	Gal	Imp.gal
	45	11.9	9.9

J030A01A-GAT

TIRE

Standard	155/80R13
Option	175/70R13
	185/60 HR 14
Spare	Full Size

J040A01A-GAT

ELECTRICAL

Battery	MF45AH, MF55AH(12V)	
Alternator	13.5V/80A	
Starter	AutoT/A	0.9 KW
	ManualT/A	0.7 KW

J050A01A-AAT

BRAKE

Type	Dual hydraulic with brake booster
Front brake type	Ventilated disc
Rear brake type	Drum
Parking brake	Cable operated on rear wheel

VEHICLE SPECIFICATIONS

J070A01A-QAT

ENGINE

ITEMS	SPECIFICATIONS			
	1.5MFI(SOHC)	1.5MFI(DOHC)	1.3MFI(SOHC)	1.3CARBURETOR
EngineType	4-Cylinderin-lineOHC			
IdleSpeed(RPM)	800 ±100	750 ±100	800 ±100	850 ±100
Ignitiontinning	BTDC 9° ±5°	BTDC 5° ±5°	BTDC 9° ±5°	BTDC 5° ±5°
Firing order	1 - 3 - 4 - 2			

J090A01A-GAT

SPARK PLUG

ITEMS	UNLEADED	LEADED
Sparkplug	NGK:BKR5ES-11 CHAMPION:RC10YC4	NGK: BKR5ES CHAMPION:RC10YC
Spark plug gap	1.0 - 1.1 mm (0.039 - 0.043 in.)	0.7 - 0.8 mm (0.028 - 0.032 in.)

VEHICLE SPECIFICATIONS

J080A05A-GAT

LUBRICATION CHART

Item	Oil & Coolant Standard		Q'ty
EngineOil	APISG OR ABOVE	SAE 20W-40, 20W-50 (ABOVE -1 0°C)	3.3 (3.49 us-qts, 2.9 Imp-qts)
		SAE 15W-40W, 1 5W-50 (ABOVE -15°C)	
		SAE 10W-30 (-25° - 40°C)	
		SAE 10W-40, 10W-50 (ABOVE -25°C)	
		SAE 5W-20*1 , *2 (BELOW -10°C)	
		SAE 5W-30*1 (BELOW 10°C)	
		SAE 5W-40*1 (BELOW 20°C)	
	*1 . Restricted by driving condition and dealing area		
*2. Not recommended for sustained high speed vehicle operation			
Engineoil consumption	Normal driving condition		MAX. 1L/1500Km
	Severe driving condition		MAX. 1L/1000Km
Transaxle	Manual	APIGL-4.SAE75W/90	2.15 liters (2.27 us-qts, 1.9 Imp-qts)
	Auto	HYUNDAI ATF SP-II M or GENUINE DIAMOND ATF SP-II M	6.1 liters (6.45 us-qts, 5.4 Imp-qts)
Powersteering	PSF-3		As required
Brakefluid	DOT3equivalent		As required
Enginecoolant	Ethylene glycol baseforaluminum radiator		5.5 liters (5.7 us-qts, 5.1 Imp-gts)

INDEX

10. INDEX

A	
Airbag.....	1-18-1-22
AirCleanerfilter.....	6-9
AirConditioner	
Care.....	6-13
Operation.....	1-47
Air Filter (For Evaporator and Blower Unit).....	1-48
Antenna.....	1-62
Ashtray.....	1-33
Automatic Transaxle	
overdrive switch.....	2-8
B	
Battery.....	2-10,6-16
Bi-Level Heating.....	1-45
Brake	
Anti-lock system.....	2-9
Checkingthebrakes.....	6-12
Fluid.....	6-12
Pedal clearance.....	6-14
Pedal free play.....	6-14
Practices.....	2-8
Breaking-In your new Hyundai.....	1-1
C	
CareofCassettetapes.....	1-60
Care of Disk.....	1-60
Catalytic Converter.....	7-1 - 7-2
Child-Protector Rear Door Lock.....	1-6
Child Restraint System.....	1-14-1-16
CigaretteLighter.....	1-32
Clock.....	1-32
Clutch	
Checkingfluid.....	6-12
Pedal free play.....	6-14
Combination Light	
Daytime running lights.....	1-29
Headlightflasher.....	1-29
Headlight switch.....	1-28
High-beam switch.....	1-29
Lanechangesignal.....	1-28
Turn signal operation.....	1-28
Compact Disk Player Operation (H920C).....	1-58 - 1-59
CoolingFans.....	6-17
Corrosion Protection	
Cleaning the interior.....	4-3
Protecting your Hyundai from corrosion.....	4-1
Washing and waxing.....	4-2
D	
Door	
Centraldoorlocking system.....	1-10
Doorlocks.....	1-5
Locking, unlocking front door with a key.....	1-5
Drive Belts.....	6-13,6-15
Driving	
Economical driving.....	2-9
Smooth cornering.....	2-10
Winter driving.....	2-10

INDEX

E		
Emission Control System.....	7-1	
Engine		
Before starting the engine.....	2-2	
Compartment (For carburator).....	6-2	
Compartment (For DOHC).....	6-3	
Compartment (For MFI).....	6-1	
Coolant.....	6-6	
Coolant temperature gauge.....	1-27	
If the engine overheats.....	3-2	
Number.....	8-1	
Oil.....	6-4	
Oil consumption.....	6-5	
Starting.....	2-4	
Engine Exhaust Can Be Dangerous.....	2-1	
F		
Fan Speed Control.....	1-43	
Fog Light		
Front.....	1-32	
Rear.....	1-32	
Front Seats		
Adjustable front seats.....	1-6	
Adjustable headrests.....	1-7	
Adjusting seatback forward and rearward.....	1-6	
Adjusting seatback angle.....	1-7	
Lumbar support control.....	1-7	
Fuel		
Capacity.....	9-1	
Gauge.....	1-27	
Recommendations.....	1-1	
Fuel Filler Lid		
Remote release.....	1-40	
Fuses.....	6-15	
G		
General Everyday Checks.....	6-4	
Glovebox.....	1-36	
H		
Hazard Warning System.....	1-31	
Headlight.....	6-18	
Headlight Leveling Device System.....	1-31	
Heating and Ventilation		
Rotarytype.....	1-43	
High-mounted rearstoplight.....	1-40	
Hood Release.....	1-41	
Horn.....	1-42	
I		
Ignition Switch.....	2-2	
Immobilizer System.....	1-2	
Instrument Cluster and Indicator.....	1-24	
Instruments and Controls.....	1-23	
Interior Light		
Withsunroof.....	1-35	
Withoutsunroof.....	1-36	
IntermittentWiper.....	1-30	
J		
Jump Starting.....	3-2	
K		
Keys.....	1-2	
If you lose your keys.....	3-8	
Positions.....	2-2	

INDEX

L	
Light Bulb Replacement.....	6-17
Limp home procedure.....	1-3
M	
Maintenance Intervals	
Explanation of scheduled maintenance items.....	5-5 - 5-7
Maintenance under severe usage conditions.....	5-4
Scheduled maintenance.....	5-2
Service requirements.....	5-1
Mirrors	
Day/night inside rearview.....	1-38
Outsiderearview.....	1-36
Manualtype.....	1-36
Electricity.....	1-37
O	
Odometer.....	1-28
P	
Parking Brake.....	1-38
PowerSteering Fluid Level.....	6-17
PretensionerSeatBelt(With A/BAG).....	1-17- 1-18
PretensionerSeatBelt(WithoutA/BAG).....	1-17
R	
Rear Seats	
Folddown.....	1-38
Rearseatentry.....	1-8
RearWindowDefrosterSwitch.....	1-31
RearWindowWiperandWasher.....	1-30
S	
SeatBelts	
2-Pointstatictype.....	1-13
3-Pointtype.....	1-12
Adjustableheight.....	1-11
Adjustingyourseatbelt.....	1-12-1-13
Careofseatbelts.....	1-10-1-11
Precautions.....	1-10
SparkPlugs.....	6-8
Speedometer.....	1-27
Starting Procedures.....	2-3-2-4
Steering Wheel	
Freeplay.....	6-17
Tiltlever.....	1-2
Stereo Radio and Cassette Tape Player Operation (H900A) ..	
1-53-1-55	
StereoRadioOperation(H900B).....	1-51-1-52
Stereo Radio Operation (H920C).....	1-56-1-57
Stereo Sound System.....	1-48-1-50
SunVisor.....	1-42
Sunroof.....	1-34
Sunshade.....	1-33
T	
Tachometer.....	1-28
TheftAlarmSystem.....	1-4
Tires	
Balancing.....	8-2
Chains.....	8-2
Changingaflatire.....	3-4
If you have a flat tire.....	3-3
Information.....	8-1
Pressure (see glove box).....	8-1
Replacement.....	8-3

INDEX

Rotation.....	8-2
Snowtires.....	8-2
Sparetire.....	3-3
Traction.....	8-2
Towing	
Emergency.....	3-8
If your car must be towed.....	3-7
Trailerorvehicletowing.....	2-12
Transaxle	
Automatic.....	2-6
Automatic transaxle fluid checking.....	6-11
Manual.....	2-4
Manual transaxle oil checking.....	6-10
Trunk.....	1-39
Remote release.....	1-40
V	
Vehicle Identification Number (VIN).....	8-1
Vehicle Specifications.....	9-1
Ventilation	
Centerventilator.....	1-45
Sideventilator.....	1-45
W	
Warning Lights.....	1-23-1-26
Windows	
Manual.....	1-8
Power.....	1-9
Windshield Wiper and Washer.....	1-28
Windshield Wiper Blades.....	6-9