

 **HYUNDAI**



accent

1996 Owner's Manual

AA010A1-A

WARRANTIES FOR YOUR HYUNDAI VEHICLE

- o New Vehicle 36 months/36,000 Mile Limited Warranty
- o New Vehicle 60 months/60,000 Mile Limited Powertrain Warranty
- o Anti-Perforation Limited Warranty
- o Emission Defect Warranty - Federal Vehicle
- o California Emission Control System Warranty (if applicable)
- o Emission Performance Warranty - Federal Vehicle
- o Replacement Parts and Accessories Limited Warranty

NOTE

Detailed warranty information is provided in your Hyundai Owner's Handbook.

ZA020A1-A

RESPONSIBILITY FOR MAINTENANCE

The maintenance requirements for your new Hyundai are found in Section 5. As the owner, it is your responsibility to see that all maintenance operations specified by the manufacturer are carried out at the appropriate intervals. When the vehicle is used in severe driving conditions, more frequent maintenance is required for some operations. Maintenance requirements for severe operating conditions are also included in Section 5.

HYUNDAI

accent

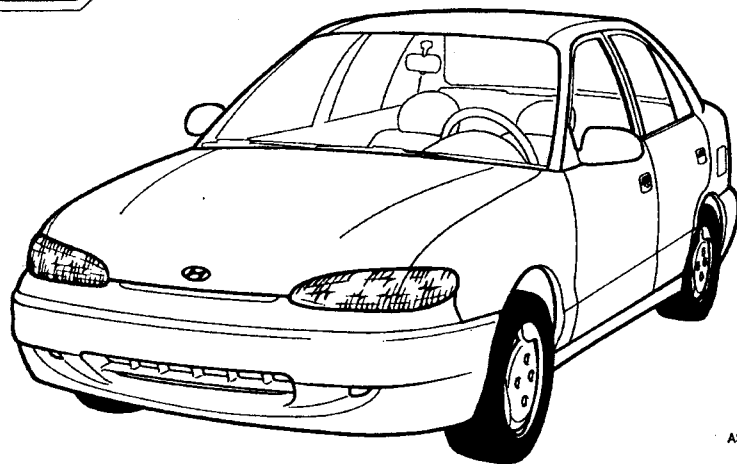

AA030A1-A

1996

OWNER'S MANUAL

Operation

Maintenance

Specifications

AS10010A

All information in this Owner's Manual is current at the time of publication. However, Hyundai reserves the right to make changes at any time so that our policy of continual product improvement may be carried out.

This manual applies to all 1996 Hyundai ACCENT models and includes descriptions and explanations of optional as well as standard equipment. As a result, you may find material in this manual that does not apply to your specific vehicle.

ZA040A1-A

FOREWORD

Thank you for choosing Hyundai. We are pleased to welcome you to the growing number of discriminating people who drive Hyundais. The advanced engineering and high-quality construction of each Hyundai we build is something of which we're very proud.

Your Owner's Manual will introduce you to the features and operation of your new Hyundai. It is suggested that you read it carefully since the information it contains can contribute greatly to the satisfaction you receive from your new car.

The manufacturer also recommends that all service and maintenance on your car be performed by an authorized Hyundai dealer. Hyundai dealers are prepared to provide high-quality service, maintenance and any other assistance that may be required.

ZA040B1-A

HYUNDAI MOTOR COMPANY

Note: Because future owners will also need the information included in this manual, if you sell this Hyundai, please leave the manual in the vehicle for their use. Thank you.

Copyright 1995 Hyundai Motor Company. All rights reserved. The material in this publication may not be reproduced in any form without written permission from Hyundai Motor Company.

TABLE OF CONTENTS

| SECTION | PAGE |
|--|------|
| 1. A GUIDED TOUR — Features of Your Hyundai | 1-1 |
| 2. BEHIND THE WHEEL — Driving Your Hyundai | 2-1 |
| 3. TROUBLE ON THE ROAD — What to do in an Emergency | 3-1 |
| 4. KEEPING THOSE GOOD LOOKS — Corrosion Prevention & Appearance Care | 4-1 |
| 5. THE KEY TO TROUBLE-FREE OPERATION — Vehicle Maintenance Requirements | 5-1 |
| 6. SATURDAY MECHANICS — Do-It-Yourself Maintenance | 6-1 |
| 7. EMISSION CONTROL SYSTEMS | 7-1 |
| 8. THINGS YOU SHOULD KNOW — Consumer Information | 8-1 |
| — Reporting Safety Defects | 8-7 |
| 9. VEHICLE SPECIFICATIONS | 9-1 |
| 10. INDEX | 10-1 |

ZA060A1-A

CAUTION: MODIFICATIONS TO YOUR HYUNDAI

Your Hyundai should not be modified in any way. Such modifications may adversely affect the performance, safety or durability of your Hyundai and may, in addition, violate conditions of the limited warranties covering the vehicle. Certain modifications may also be in violation of regulations established by the U.S. Department of Transportation and other federal or state agencies.

ZA070A1-A

TWO-WAY RADIO INSTALLATION CAUTION

Your vehicle is equipped with electronic fuel injection and other electronic components. It is possible for an improperly installed/adjusted two-way radio to adversely affect electronic systems. For this reason, we recommend that you carefully follow the radio manufacturer's instructions or consult your Hyundai dealer for precautionary measures or special instructions.

SAFETY AND VEHICLE DAMAGE WARNING

This manual includes information titled as WARNING, CAUTION and NOTE.

These titles indicate the following:

WARNING

This indicates that a condition may result in harm or injury to you or other persons if the warning is not heeded. Follow the advice provided with the warning.

CAUTION:

This indicates that a condition may result in damage to your vehicle or its equipment if the caution is not heeded. Follow the advice provided with the caution.

NOTE:

This indicates that interesting or helpful information is being provided.

ZB000A1-A

1. A GUIDED TOUR

Features of Your Hyundai

FEATURES OF YOUR HYUNDAI

ZB010A1-A

FUEL RECOMMENDATIONS

Use Unleaded Gasoline

Unleaded gasoline with a Pump Octane Rating of 87 (Research Octane Number 91) or higher must be used in your Hyundai.

If leaded gasoline is used, it will cause the catalytic converter to become ineffective and the emission control system to malfunction.

This can also result in increased maintenance expense.

To avoid accidental use of leaded fuel, the larger nozzle used with leaded gasoline at service stations cannot be inserted into the fuel tank opening of your Hyundai.

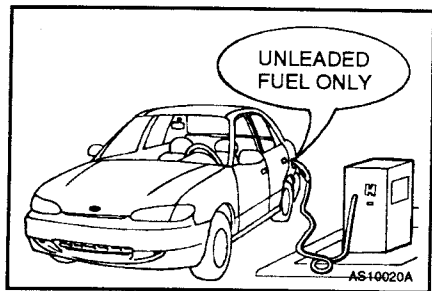

ZB010B1-A

What about Gasohol?

Gasohol (a mixture of 90% unleaded gasoline and 10% ethanol or grain alcohol) may be used in your Hyundai. However, if your engine develops driveability problems, the use of 100% unleaded gasoline is recommended. Use of fuels with unspecified quantities of alcohol, or alcohols other than ethanol, should not be used.

ZB010F1-A

Use of MTBE

Hyundai recommends that fuels containing MTBE (Methyl Tertiary Butyl Ether) over 15.0% vol. (Oxygen Content 2.7% weight) should not be used in your Hyundai. Fuel containing MTBE over 15.0% vol. (Oxygen Content 2.7% weight) may reduce vehicle performance and produce vapor lock or hard starting.

ZB010C4-A

Do not Use Methanol

Fuels containing methanol (wood alcohol) should not be used in your Hyundai. This type of fuel can reduce vehicle performance and damage components of the fuel system.

CAUTION:

Your Hyundai's New Vehicle Limited Warranty may not cover damage to the fuel system and performance problems that are caused by the use of methanol or fuels containing methanol or fuels containing MTBE over 15.0% vol. (Oxygen Content 2.7% weight).

ZB010E2-A

GASOLINES FOR CLEANER AIR

To help contribute to cleaner air, Hyundai recommends that you use gasolines treated with detergent additives, which help to prevent deposit formation in the engine. These gasolines will help the engines run cleaner and the Emission Control System performance.

ZB010D1-A

Operation in Foreign Countries

If you are going to drive your Hyundai in another country, be sure to:

- o Observe all regulations regarding registration and insurance.
- o Determine that acceptable fuel is available.

ZB020A1-A

BREAKING IN YOUR NEW HYUNDAI

During the First 1200 Miles (2000 km)

No formal "break-in" procedure is required with your new Hyundai. However, you can contribute to the economical operation and durability of your Hyundai by observing the following recommendations during the first 1200 miles (2000 km).

- o Don't drive faster than 55 MPH (88 kph).
- o While driving, keep your engine speed (rpm, or revolutions per minute) between 2000 and 4000 rpm.
- o Use moderate acceleration. Don't use full-throttle starts.
- o For the first 200 miles (300 km), try to avoid hard stops.

FEATURES OF YOUR HYUNDAI

- o Don't lug the engine (in other words, don't drive so slowly in too-high a gear that the engine "bucks": shift to a lower gear).
- o Whether going fast or slow, vary your speed from time to time.
- o Don't let the engine idle longer than 3 minutes.

ZB030A1-A KEYS

For greater convenience, the same key operates all the locks in your Hyundai. However, because the doors can be locked without a key, carrying a spare key is recommended in case you accidentally lock one key inside the car.

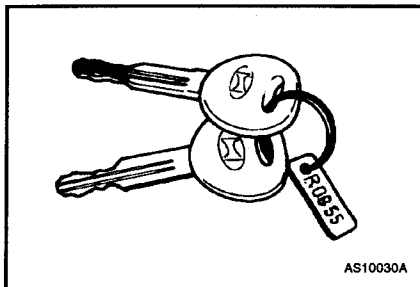

ZB030B1-A

Record Your Key Number

A code number is stamped on the key number plate that came with the keys to your Hyundai. This key number plate should be kept in a safe place, not in the vehicle. The key number should also be recorded in a place where it can be found in an emergency.

If you need additional keys, or if you should lose your keys, your authorized Hyundai dealer can make new keys if you can supply the key number.

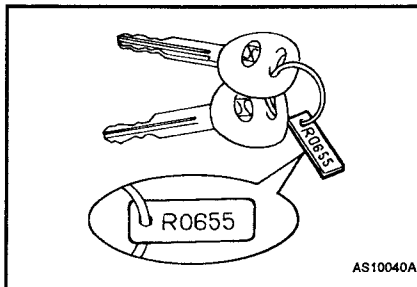

AB040A1-A

DOOR LOCKS

- o Before you drive away — especially if there are children in the car — be sure that all the doors are securely closed and locked. This helps assure that doors will not be opened accidentally. Also, when combined with the proper use of seat belts, locking the doors helps keep occupants from being ejected from the car in case of an accident.
- o Before opening the door, always look and avoid on coming traffic.

ZB040B1-A

Locking Using the Key

Lock the door by turning the key toward the front of the car and unlock it by turning it toward the rear.

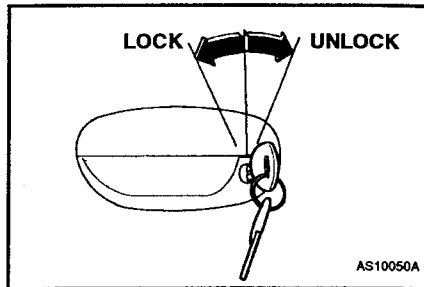

FEATURES OF YOUR HYUNDAI

DB040C1-A

Locking from Outside

The doors can be locked without a key.

First push the lock button down, then close the door.

NOTE:

Be careful not to lock your key in the vehicle.

AB040D1-A

Locking from Inside

To lock your Hyundai from inside, simply close the door and push the lock button down.

When this is done, the door cannot be opened using either the inside or the outside door handle.

To unlock the car from the inside, pull up the lock button and then pull the inside door handle.

ZB050A1-A

CHILD-PROTECTOR REAR DOOR LOCK

Your Hyundai is equipped with a "child-protector" rear door lock assembly. When the lock is engaged, the rear door cannot be opened from inside. Its use is recommended whenever there are children in the rear seat.

To engage the child-protector feature so that the door cannot be opened from inside, move the child-protector lever to the "LOCK" position and close the door. Move the lever to the "FREE" position when normal door operation is desired.

If you wish to be able to open the door from the outside, pull the outside door handle to its upward position.

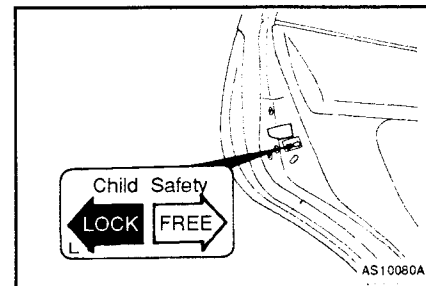
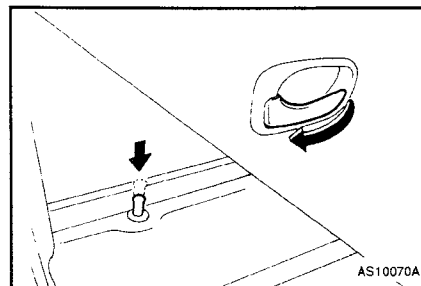
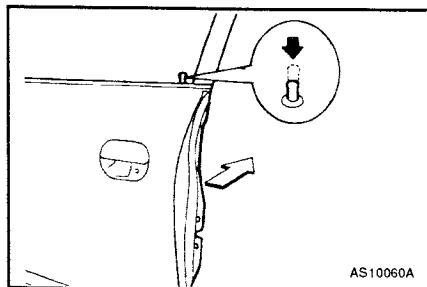

FEATURES OF YOUR HYUNDAI

ZB060A2-A

ADJUSTABLE FRONT SEATS

WARNING

Never attempt to adjust the seat while the vehicle is moving. This could result in loss of control, and an accident causing death, serious injury, or property damage.

JB060B1-A

Adjusting Seat Forward and Rearward

To move the seat toward the front or rear, pull the lock release lever upward. This releases the seat on its track so you can move it forward or rearward to the desired position. When you find the position you want, release the lever and slide the seat forward or rearward on its track until it locks into position and cannot be moved further.

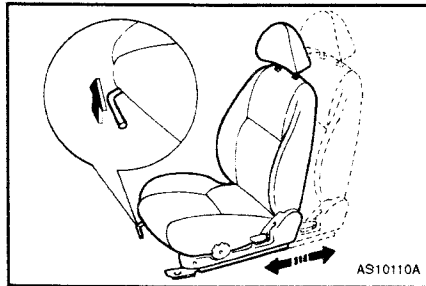

ZB060C1-A

Adjusting Seatback Angle

To recline the seatback, lean forward to take your weight off it, then pull up on the recliner control lever at the outside edge of the seat. Now lean back until the desired seatback angle is achieved. To lock the seatback into position, release the recliner control lever.

WARNING

To minimize risk of personal injury in the event of a collision or sudden stop, both the driver and passenger seatbacks should always be in a nearly upright position while the vehicle is in motion. The protection provided by the seat belts may be reduced significantly when the seatback is reclined. There is greater risk that the passenger will slide under the belt resulting in serious injury when the seatback is reclined.

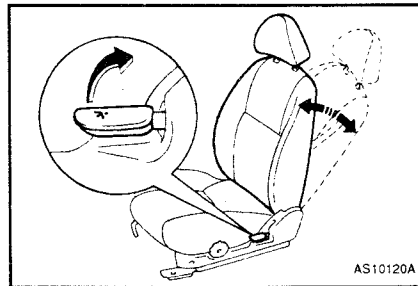

ZB060D1-A

Adjustable Headrests

To raise the headrest, pull it up. To lower it, push the headrest down. For maximum effectiveness in case of an accident the headrest should be adjusted so the top of the headrest is at the same height as the top of the occupant's ears. For this reason, the use of a cushion that holds the body away from the seatback is not recommended.

WARNING

Do not operate vehicle with the headrests removed. Headrests may provide protection against neck injuries when properly adjusted.

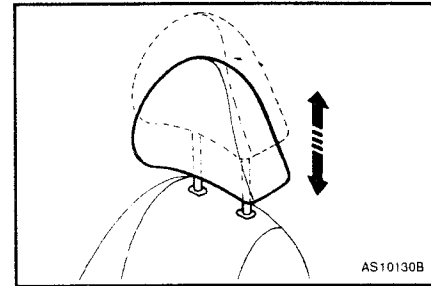

FEATURES OF YOUR HYUNDAI

ZB060E1-A

Lumbar Support Control (If installed) (Driver's seat only)

The front seats in some Hyundais are equipped with adjustable lumbar support. To increase the amount of lumbar support, turn the handle forward. To decrease it, turn the handle toward the rear.

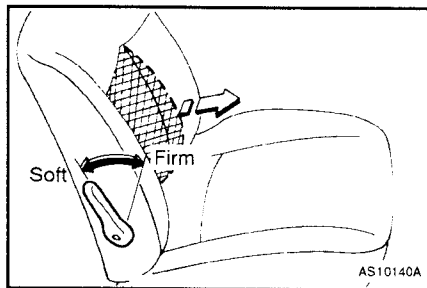

ZB060F1-A

Seat Cushion Height Adjustment (If installed) (Driver's seat only)

To adjust the height of the seat cushion, turn the seat cushion control knob in the appropriate direction.

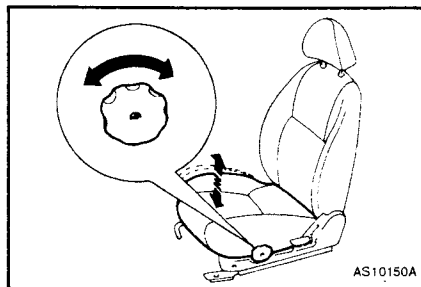

ZB070A1-A

REAR SEAT ENTRY (For 3-door model)

The front passenger seatback should be tilted to enter the rear seat.

By pulling up on the recliner control lever (1) at the outside of the front passenger seat, the seatback will tilt forward and the seat will automatically slide forward.

Rear seat occupants can tilt the front passenger seatback by depressing the foot lever (2) as shown in the drawing.

WARNING

Passengers sitting in the rear seat should be careful not to accidentally press the foot lever (2) while the vehicle is moving, as this may cause the seat back to move forward and injure a front seat occupant.

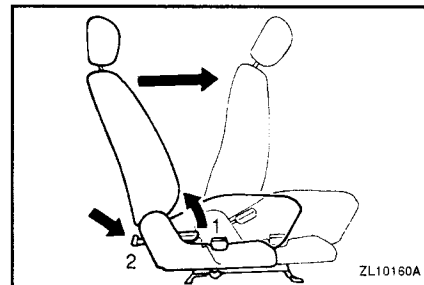

FEATURES OF YOUR HYUNDAI

ZB080A1-A

WINDOW GLASS

To raise or lower the window, turn the window regulator handle clockwise or counterclockwise.

WARNING

When opening or closing the windows, make sure your passenger's arms and hands are safely out of the way.

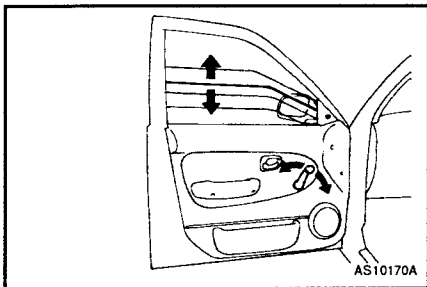

AB080B1-A

POWER WINDOWS (If installed)

The power windows operate only when the ignition key is in the "ON" position. The main switches are located on the main console and control the front window. The windows may be operated by depressing the desired switch.

CAUTION:

- (1) Be careful that head or hands are not trapped by a closing window.
- (2) If passengers remain in the car when you leave, especially if a child remains alone, always remove the ignition key for safety.

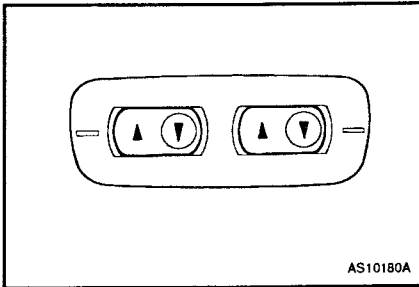

AB090A1-A

SEAT BELT PRECAUTIONS

All occupants of the vehicle must wear their seat belts at all times. Note that this vehicle is equipped with a Supplemental Restraint (Airbag) System as discussed beginning on page 1-14. The seat belts must be used in conjunction with the supplemental airbag system. Your states laws may require that some or all occupants of the vehicle use seat belts. The possibility of increased injury or severity of injury in an accident will be increased if this elementary safety precaution is not observed. In addition, the following recommendations are made:

AB090B1-A

Infant or Small Child

Some states require the use of child restraint systems for infants and small children. Whether this is required by law or not, it is strongly recommended that a child restraint seat or infant restraint system be placed in the rear seat and used for infants or small children weighing less than 40 pounds. Information about the use of such restraints is included beginning on page 1-10. Such restraints must only be used in the rear seat.

NOTE:

Small children are best protected in an accident when properly restrained by a child restraint system that meets the requirements of the Federal Motor Vehicle Safety Standards.

FEATURES OF YOUR HYUNDAI

ZB090C2-A

Larger Children

It is recommended that larger children occupy the rear seat and wear their seat belts. If the child is in the front seat, the child should be securely restrained by the seat belt. Under no circumstances should the child be allowed to stand or kneel on the seat. Children are afforded the most safety in the event of an accident when they are restrained by a proper child restraint system in the rear seat.

ZB090D2-A

Pregnant Women

The use of a seat belt is recommended for pregnant women to lessen the chance of injury in an accident. When a seat belt is used, the lap belt portion should be placed as low and snugly as possible on the hips, not across the abdomen. For specific recommendations, consult a physician.

ZB090E1-A

Injured Person

A seat belt should be used when an injured person is being transported. When this is necessary, you should consult a physician for recommendations.

ZB090F1-A

One Person Per Belt

Two people (including children) should never attempt to use a single seat belt. This could increase the severity of injuries in case of an accident.

ZB090G1-A

Do Not Lie Down

To reduce the chance of injuries in the event of an accident, and to achieve maximum effectiveness of the restraint system, all passengers should be sitting up and the front seats should be in an upright position when the car is moving. A seat belt cannot operate properly if the person is lying down in the rear seat or if the front seat is at or near a fully reclined position.

ZB090H2-A

CARE OF SEAT BELTS

Seat belt systems should never be disassembled or modified. In addition, care should be taken to assure that seat belts and belt hardware are not damaged by seat hinges, doors or other abuse.

WARNING

When you return the rear seatback to its upright position after the rear seatback was folded down, be careful not to damage the seat belt webbing or buckle. Be sure that the webbing or buckle does not get caught or pinched in the rear seat.

ZB090I1-A

Periodic Inspection

It is recommended that all seat belts be inspected periodically for wear or damage of any kind. Parts of the system that are damaged should be replaced as soon as possible.

ZB090J1-A

Keep Belts Clean and Dry

Seat belts should be kept clean and dry. If belts become dirty, they can be cleaned using a mild soap solution and warm water. Bleach, dye, strong detergents or abrasives should not be used because they may damage and weaken the fabric.

ZB090K1-A

When to Replace Seat Belts

The entire seat belt assembly or assemblies should be replaced if the vehicle has been involved in an accident. This should be done even if no damage is visible. Additional questions concerning seat belt operation should be directed to your Hyundai Dealer.

AB090Z1-B

HEIGHT ADJUSTABLE FRONT SEAT SHOULDER BELT (If installed)

You can adjust the height of the shoulder belt anchor to one of the 4 positions.

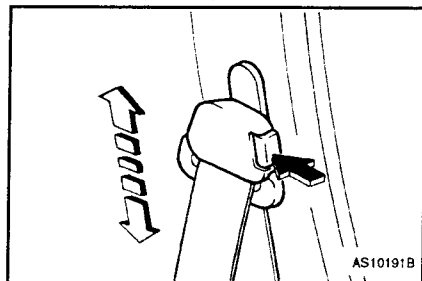

FEATURES OF YOUR HYUNDAI

If the height of the adjusting seat belt is too near your neck, you will not be getting the most effective protection.

To adjust the height of seat belt anchor, lower or raise the height adjuster into an appropriate position when the height adjuster knob is pulled up.

Release the button the lock the anchor into position. Try to slide the releasing the button the make sure that it has locked into position

WARNING

The height adjuster must be in the lock position when the vehicle is moving.

YB090T1-A

SEAT BELT-Driver's 3-Point System with Emergency Locking Retractor To Fasten Your Belt

To fasten your seat belt, pull it out of the retractor and insert the metal tab into the buckle. There will

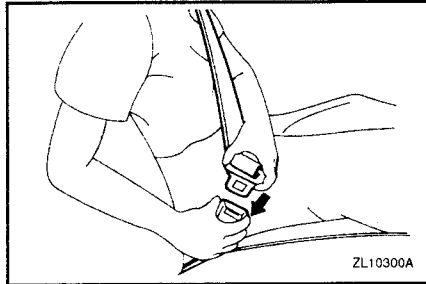

be an audible "click" when the tab locks into the buckle.

The seat belt automatically adjusts to the proper length only after the lap belt portion is adjusted manually so that it fits snugly around your hips. If you lean forward in a slow, easy motion, the belt will extend and let you move around. If there is a sudden stop or impact, however, the belt will lock into position. It will also lock if you try to lean forward too quickly.

NOTE:

If the driver's seat belt is not fastened when the ignition key is in the "ON" position, the seat belt warning light will flash and the warning chime will sound for approximately six seconds.

YB920A4-A

SEAT BELTS-Front Passenger and Outboard Rear Seat 3-Point System with Combination Locking Retractor To Fasten Your Belt

Combination retractor type seat belts are installed in the rear seat outboard positions to help accommodate the installation of child restraint systems. Although a combination retractor is also installed in the front passenger seat position, Hyundai recommends that children always be seated in the rear seat.

This type of seat belt combines the features of both an emergency locking retractor seat belt and an automatic locking retractor seat belt.

To fasten your seat belt, pull it out of the retractor and insert the metal tab into the buckle. There will be an audible "click" when the tab locks into the buckle. When not securing a child restraint, the seat belt operates in the same way as driver's seat belt (Emergency Locking Retractor Type). It automatically adjusts to the proper length only after the lap belt portion of the seat belt is adjusted manually so that it fits snugly around your hips. When the seat belt is fully extended from the retractor to allow the installation of a child restraint system, the seat belt operation changes to allow the belt to retract, but not to extend. (Automatic Locking Retractor Type)

NOTE:

Although the combination retractor provides the same level of protection for seated passengers in either emergency or automatic locking modes, it is recommended that seated passengers use the emergency locking feature for improved convenience. The automatic locking function is intended to facilitate child restraint installation. To convert from the automatic locking feature to the emergency locking operation mode, allow the unbuckled seat belt to fully retract.

FEATURES OF YOUR HYUNDAI

WARNING

- o For maximum restraint system protection, the seat belts must always be used when-ever the car is moving.
- o Seat belts are most effective when seatbacks are in the upright position.
- o Hyundai recommends that children be seated in the rear seats.
- o The shoulder belt should be positioned midway over the shoulder nearest the door for the most effective protection. Never wear the seat belt under the arm nearest the door.
- o Avoid wearing twisted seat belts.
- o Be careful not to damage the belt webbing or hardware.
- o The retractors lock only on sudden impacts or stops. The belt will allow some freedom of movement if done slowly.

AB090U1-A

Adjusting Your Seat Belt

WARNING

You should place the lap belt portion as low as possible and snugly across your hips, not on your waist. If the lap belt is located too high and on your waist, it may increase the chance of injury in the event of a collision. Both arms should not be under or over the shoulder belt. Rather, one should be over and the other under, as shown in the illustration.

ZB090V1-A

To Release the Seat Belt

The seat belt is released by pressing the release button in the locking buckle. When it is released, the belt should automatically draw back into the retractor.

If this does not happen, check the belt to be sure it is not twisted, then try again.

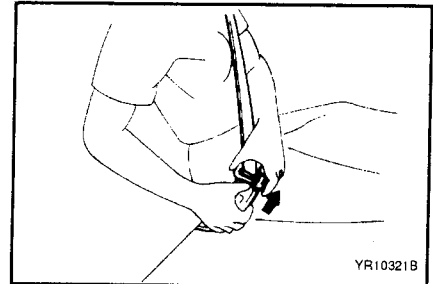
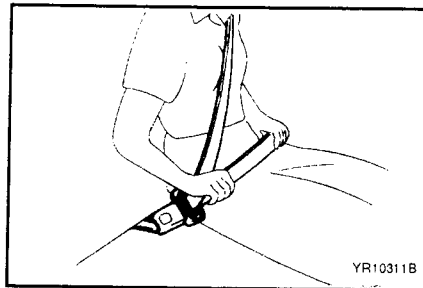

FEATURES OF YOUR HYUNDAI

ZB090W2-A

SEAT BELTS

(2-Point Static Type) (Rear Seat Center)

To Fasten Your Seat Belt

To fasten a 2-point static type seat belt, insert the metal tab into the locking buckle. There will be an audible "click" when the tab locks into the buckle. Check to make sure the belt is properly locked and that the belt is not twisted.

ZB090X2-A

Adjusting Your Seat Belt

With a 2-point static type seat belt, the length must be adjusted manually so it fits snugly around your body. Fasten the belt and pull on the loose end to tighten. The belt should be placed as low as possible on your hips, not on your waist. If the belt is too high, it could increase the possibility of your being injured in an accident because you could slide under it.

ZB090Y1-A

To Release the Seat Belt

When you want to release the seat belt, press the button in the locking buckle.

WARNING

The center lap belt latching mechanism is different from those for the rear seat shoulder belts. When fastening the rear seat shoulder belts or the center lap belt, make sure they are inserted into the correct buckle to obtain protection from the seat belt system and assure proper operation.

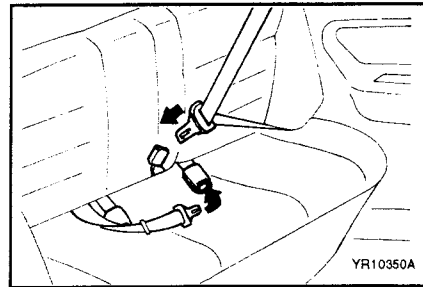
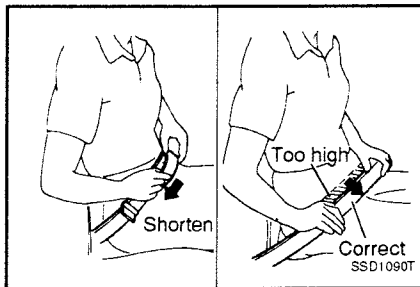
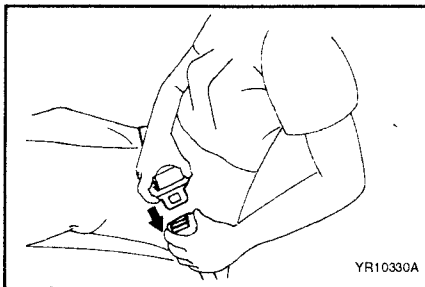

FEATURES OF YOUR HYUNDAI

JB100A1-A

CHILD RESTRAINT SYSTEM

Children riding in the car should sit in the rear seat and be restrained to minimize the risk of injury in an accident, sudden stop or sudden maneuver. According to accident statistics provided by the National Highway Traffic Safety Administration (NHTSA), children are safer when properly restrained in the rear seating positions than in the front seat. Larger children should use one of the seat belts provided.

For smaller children, we strongly recommend the use of a commercially available child restraint system that meets the requirements of the Federal Motor Vehicle Safety Standards, (FMVSS), because it offers the most protection against injury or death. All states now have laws which require that small children must be seated in a child passenger seat restraint system. Check local laws. All child restraint systems are designed to be secured by lap belts or the lap belt portion of a lap-shoulder belt.

Children could be injured in a crash if their restraints are not properly secured. For small children and babies we strongly recommend a child seat or infant seat. Before buying a particular child restraint system, make sure it fits your car seat and seat belts, and fits your child. Follow all the instructions provided by the manufacturer when installing the child restraint system.

WARNING

- o **A child restraint system must be placed in the rear seat. Never install a child restraint system on the front passenger's seat. Should an accident occur and cause the passenger-side supplemental Airbag to deploy, it could severely injure an infant seated in a child restraint. Thus only use a child restraint in the rear seat of your vehicle.**
 - o **Since a safety belt or child restraint system can become very hot if it is left in a closed vehicle, be sure and check the seat cover and buckles before placing a child there.**
 - o **When the child restraint system is not in use, store it in the trunk or fasten it with a safety belt so that it will not be thrown forward in the case of a sudden stop or accident.**
 - o **Children who are not required by law to be in a child restraint should sit in the rear seat and be restrained with the seat belt.**
 - o **Always make sure that the shoulder belt portion of the outboard lap/shoulder belt is positioned midway over the shoulder-never across the neck. The lap belt portion of the lap/shoulder belt or the center seat lap belt must always be positioned as low as possible on your hips, not on your waist.**
- o **If the seat belt will not properly fit the child, we recommend the use of an approved booster seat in the rear seat in order to raise the child's seating height so that the seat belt will properly fit the child. Before purchasing a booster seat, make sure that it meets applicable Federal Motor Vehicle Safety Standards and that it is satisfactory for use with this vehicle.**
 - o **Never allow a child to stand up or kneel on the seat.**
 - o **Never use an infant carrier or child safety seat that "hooks" over a seatback; it may not provide adequate security in an accident.**
 - o **Never allow a child to be held in a person's arms while they are in a moving vehicle, as this could result in serious injury to the child in the event of an accident or sudden stop. Holding a child in a moving vehicle does not provide the child with any means of protection during an accident, even if the person holding the child is wearing a seat belt.**

FEATURES OF YOUR HYUNDAI

AB100B1-A

Using a Child Restraint System

To install a child restraint hook holder, use a 5/16" 18 UNC thread bolt and 10 mm spacer as indicated in the illustration below. You can damage the holder nut on your vehicle if you force a bolt with a different thread into the holder nut.

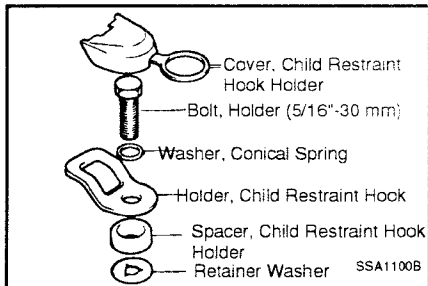

ZB100C1-A

CHILD RESTRAINT HOOK HOLDER NUT LOCATION

Three child restraint hook holder nuts are located on the rear seat package tray (4 door) and the anchor holes are covered with plugs.

If you want to install a child restraint system hook holder, remove one of the 3 anchorage trim plugs from the rear seat package tray trim, then install

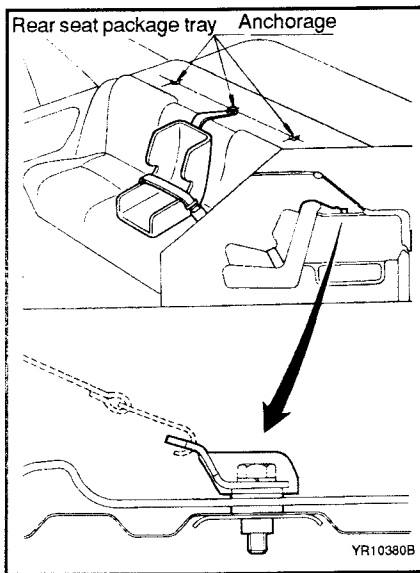

the hook holder for your child restraint system with the bolt and spacer and torque to 1.7~2.6 kgf.m (12.3~18.8 lb.ft, 16.7~25.5 N.m).

ZB100D1-A

CHILD RESTRAINT HOOK HOLDER NUT LOCATION

Three child restraint hook holder nuts are located on the back panel (3 door).

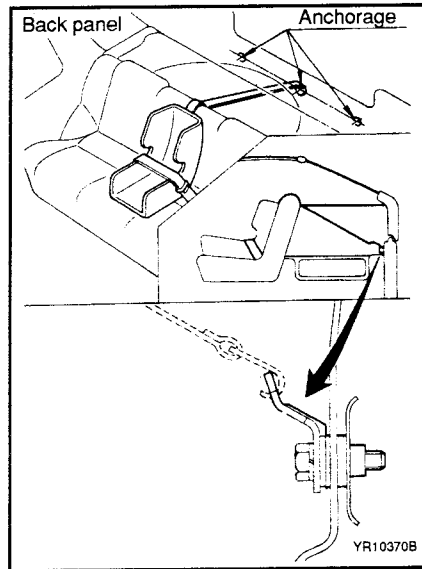

FEATURES OF YOUR HYUNDAI

If you want to install a child restraint system hook holder, remove one of the 3 anchorage trim plugs from the back panel, then install the hook holder for your child restraint system with the bolt and spacer and torque to 1.7~2.6 kgf.m (12.3~18.8 lb.ft, 16.7~25.5 N.m).

JB100F1-A

Installation on Rear Seat Center Position

Use the center seat belt for the rear seat to secure the child restraint system as illustrated. After installation of the child restraint system, rock the child seat back and forth, and side to side to ensure that it is properly secured by the seat belt.

If the child seat moves, readjust the length of the seat belt. Then, if equipped, insert the child restraint tether strap hook into the child restraint hook holder and tighten to secure the seat. Always refer to the child restraint system manu-

facturer's recommendation before installing the child restraint system in your vehicle.

YB100G2-A

Installation on Outboard Rear Seats

To install a child restraint system on the outboard rear seats, extend the shoulder/lap belt entirely from its retractor until a "click" is felt. This will engage the seat belt retractor automatic locking feature, which allows the seat belt to retract but not extend. Install the child restraint system, buckle the seat belt and allow the seat belt to take up any slack. Make sure that the lap portion of the belt is tight around the child restraint system and the shoulder portion of the belt is positioned so that it can not interfere with the child's head or neck. Also, double check to be sure that the retractor has engaged the Automatic Locking feature by trying to extend webbing out of the retractor. If the retractor is in the Automatic

Locking mode, the belt will be locked. After installation of the child restraint system, try to move it in all directions to be sure the child restraint system is securely installed. If you need to tighten the belt, pull more webbing toward the retractor. When you unbuckle the seat belt and allow it to retract, the retractor will automatically revert back to its normal seated passenger Emergency Locking usage condition.

NOTE:

- o Before installing the child restraint system in any seating position, read the instructions supplied by the child restraint system manufacturer.
- o If the seat belt does not operate as described, have the system checked immediately by your authorized Hyundai dealer.

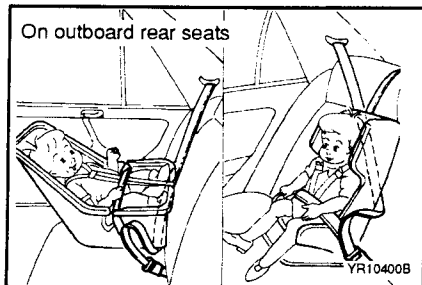
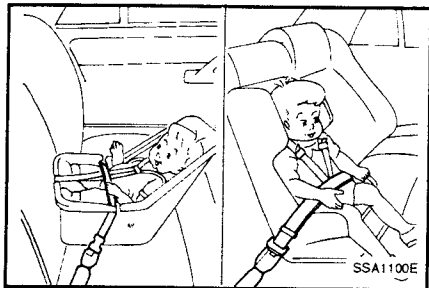

FEATURES OF YOUR HYUNDAI

WARNING

- o If the retractor is not in the Automatic Locking mode, the child restraint system can move when your vehicle turns or stops abruptly.
- o Do not install a child restraint system in the front passenger seat. Should an accident occur and cause the passenger side supplemental airbag to deploy, it could severely injure an infant seated in a child restraint. Therefore, only use a child restraint in the rear seat of your vehicle.

YB150A2-A

SUPPLEMENTAL RESTRAINT (AIRBAG) SYSTEM

Your Hyundai is equipped with a Supplemental Restraint (Airbag) System. The indications of the system's presence are the letters "SRS Air Bag" embossed on the airbag pad cover in the steering wheel and the passenger's side front panel pad above the glove box.

The Hyundai SRS consists of airbags installed under the pad covers in the center of the steering wheel and the passenger's side front panel above the glove box. The purpose of the SRS is to provide the vehicle's driver and/or the front passenger with additional restraint than that offered by the seat-belt system alone, in case of a frontal impact of sufficient severity.

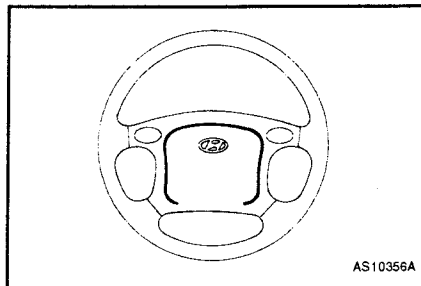

AS10356A

NOTE:

Be sure to read information about the SRS on the labels provided on the backside of the sun visors and in the glove box.

WARNING

As its name implies, the SRS is designed to work with, and be supplemental to, the driver's and the passenger's three point seat belt systems and is not a substitute for them. Therefore, your seat belts must be worn at all times while the vehicle is in motion. In addition, the airbags deploy only in certain frontal impact conditions severe enough to likely cause significant injury to the vehicle occupants.

The SRS is designed to deploy the airbags only when an impact is sufficiently severe and when the impact angle is less than 30° from the forward longitudinal axis of the vehicle and will not deploy in side, rear or rollover impacts.

For maximum safety protection in all types of crashes, all occupants including the driver should always wear their seat belts whether or not an airbag is also provided at their seating position to minimize the risk of severe injury or death in the event of a crash. Do not sit or lean unnecessarily close to the airbag while the vehicle is in motion.

FEATURES OF YOUR HYUNDAI

YB150B1-A

SRS Components and Functions

The SRS consists of the following components:

- Driver's Side Airbag Module
- Passenger's Side Airbag Module
- Knee Bolster
- SRS Service Reminder Indicator (SRI)
- SRS Control Module (SRSCM)

The SRSCM continually monitors all elements while the ignition is "ON" to determine if a frontal or near-frontal impact is severe enough to require airbag deployment.

The SRS service reminder indicator (SRI) on the instrument panel will blink for about 6 seconds after the ignition key is turned to the "ON" position or after the engine is started, after which the SRI should go out.

The airbag modules are located both in the center of the steering wheel and in the front passenger's panel above the glove box. When the SRSCM detects a considerable impact to the front of the vehicle, it will automatically deploy the airbags.

Upon deployment, tear seams molded directly into the pad covers will separate under pressure from the expansion of the airbags. Further opening of the covers then allows full inflation of the airbags.

A fully inflated airbag in combination with a properly worn seat belt slows the driver's or the passenger's forward motion, thus reducing the risk of head or chest injury.

After complete inflation, the airbag immediately starts deflating, enabling the driver to obtain forward visibility.

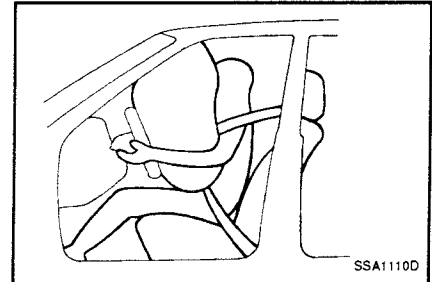
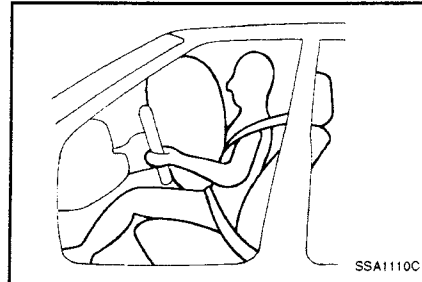
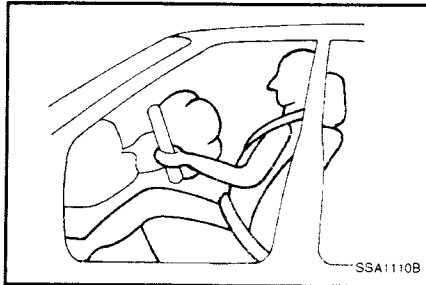

FEATURES OF YOUR HYUNDAI

WARNING

- o When the SRS is activated, there may be a loud noise and fine dust will be released through the instruments. These conditions are normal and are not hazardous. However, the fine dust generated during airbag deployment may cause skin irritation. Be sure to wash your hands and face thoroughly with lukewarm water and a mild soap after an accident in which the airbags were deployed.
- o The SRS can function only when the ignition key is in the "ON" position. If the SRS SRI does not come on, or continuously remains on, after flashing for about 6 seconds when the ignition key is turned to the "ON" position, or after the engine is started, or comes on while driving, the SRS is not working properly.

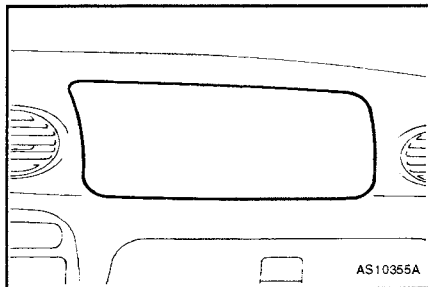

If this occurs, have your vehicle immediately inspected by your Hyundai dealer.

- o Before you replace a fuse or disconnect a battery terminal, turn the ignition key to the "LOCK" position or remove the ignition key. Never remove or replace fuse No.15 when the ignition key is in the "ON" position. Failure to heed this warning will cause the SRS SRI to illuminate.

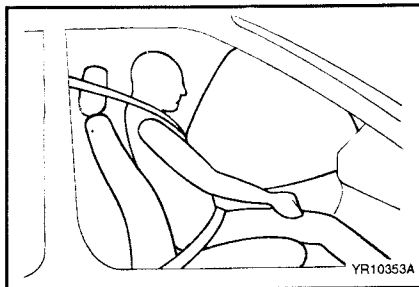

YB150C1-A

SRS Care

- o The SRS is virtually maintenance-free and so there are no parts you can safely service by yourself. The entire SRS system must be inspected by an authorized Hyundai dealer 10 years after the date that the vehicle was manufactured.
- o Any work on the SRS system, such as removing, installing, repairing, or any work on the steering wheel must be performed by a qualified Hyundai technician. Improper handling of the airbag system may result in serious personal injury.

WARNING

- o Modification to SRS components or wiring, including the addition of any kind of badges to the pad covers or modifications to the body structure, can adversely affect SRS performance and lead to possible injury.
- o For cleaning the airbag pad covers, use only a soft, dry cloth or one which has been moistened with plain water. Solvents or cleaners could adversely affect the airbag covers and proper deployment of the system.

FEATURES OF YOUR HYUNDAI

- o No objects should be placed over or near the airbag modules on the steering wheel, instrument panel, and the front passenger's panel above the glove box, because any such object could cause harm if the vehicle is in a crash severe enough to cause the airbags to inflate.
- o If the airbags inflate, they must be replaced by an authorized Hyundai dealer.
- o Do not tamper with or disconnect SRS wiring, or other components of the SRS system. Doing so could result in injury, due to accidental firing of the airbags or by rendering the SRS inoperative.
- o Do not install a child restraint system in the front passenger seat position. A child restraint system must never be placed in the front seat. The infant or baby could be severely injured by an airbag deployment in case of an accident.
- o If components of the airbag system must be discarded, or if the vehicle must be scrapped, certain safety precautions must be observed. Your Hyundai dealer knows these precautions and can give you the necessary information. Failure to follow these precautions and procedures could increase the risk of personal injury.
- o If you sell your vehicle, be sure to inform the new owner of these important points and make certain that this manual is transferred to the new owner.

FEATURES OF YOUR HYUNDAI

AB110A2-A

INSTRUMENTS AND CONTROLS

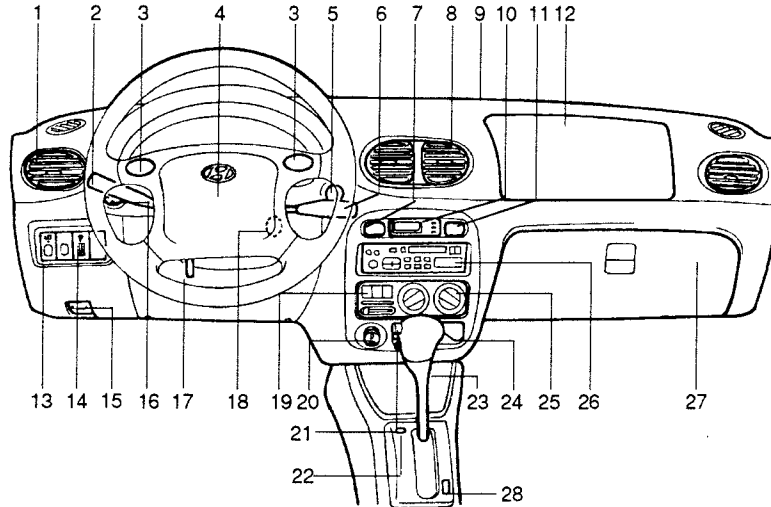

AS10450A

1. Side Air Vent Louver
2. Multi-Function Light Switch
3. Horn Button
4. SRS Air Bag (Driver side)
5. Rear Defroster Switch
6. Windshield Wiper/Washer Switch
7. Rear Wiper Switch/Rear Washer Switch
8. Center Air Vent Louver
9. Defroster Ventilation Outlet
10. Digital Clock (If installed)

11. Hazard Warning Switch
12. SRS Air bag (Passenger side)
13. Front Fog Light Switch (If installed)
14. Panel Brightness Control Knob (Rheostat switch)
15. Hood Release Lever
16. Remote Outside Mirror Switch (If installed)
17. Steering Wheel Tilt Lever
18. Ignition Switch and Keys

19. Air Conditioning Switch
20. Cigarette Light
21. Overdrive Switch (Auto T/A only)
22. Shift Lock Release Cap (If installed)
23. Drink Holder
24. Ashtray
25. Heating/Air Conditioning Control Panel
26. Audio System
27. Glove Box
28. Normal/Economy Switch (Auto T/A only)

FEATURES OF YOUR HYUNDAI

AB110B1-A

INSTRUMENT CLUSTER AND INDICATOR

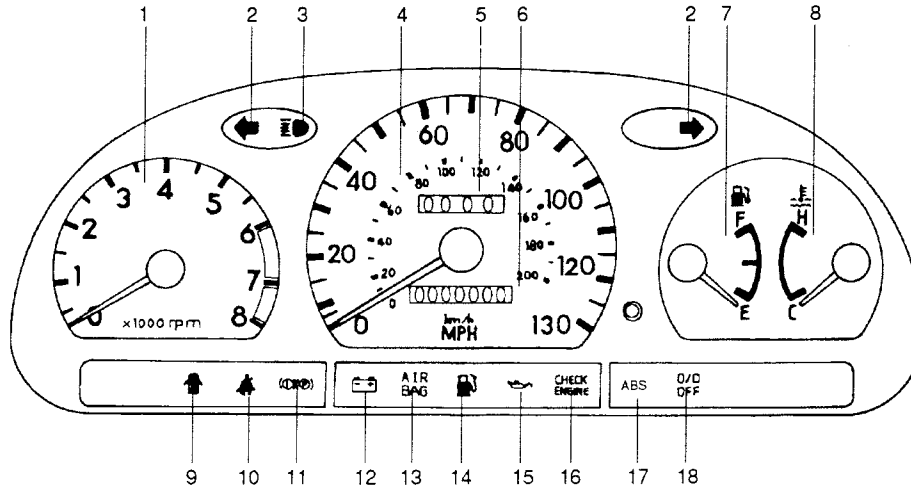

AS10460A/AS10500B

- | | | |
|--------------------------------|---|---|
| 1. Tachometer (If installed) | 8. Temperature Gauge | 14. Low Fuel Warning Light |
| 2. Turn Signal Indicator Light | 9. Door Ajar Warning Light | 15. Oil Pressure Warning Light |
| 3. High Beam Indicator Light | 10. Seat Belt Warning Light | 16. Malfunction Indicator Lamp (MIL) |
| 4. Speedometer | 11. Parking Brake/Brake Fluid Level Warning Light | 17. ABS Service Reminder Indicator (If installed) |
| 5. Trip Odometer | 12. Charging System Warning Light | 18. Overdrive Off Indicator Light (If installed) |
| 6. Odometer | 13. SRS Service Reminder Indicator | |
| 7. Fuel Gauge | | |

FEATURES OF YOUR HYUNDAI

ZB110E2-A

O/D OFF INDICATOR

When the overdrive switch is turned on, the overdrive off indicator will go out. This amber indicator will be illuminated when the overdrive switch is turned off. (Auto T/A only)

ZB110G1-A

TURN SIGNAL INDICATOR LIGHTS

The blinking green arrows on the instrument panel show the direction indicated by the turn signals. If the arrow comes on but does not blink, blinks more rapidly than normal, or does not blink at all, a malfunction in the turn signal system is indicated. Your dealer should be consulted for repairs.

ZB110I1-A

SEAT BELT REMINDER LIGHT AND CHIME

The seat belt reminder light comes on for 6-30 seconds when the ignition key is turned from the "OFF" position to "ON" or "START". If the driver's seat belt is not fastened, the warning chime will sound at the same time.

ZB110J1-A

HIGH BEAM INDICATOR LIGHT

The high beam indicator light comes on whenever the headlights are switched to high beam.

ZB110K1-A

OIL PRESSURE WARNING LIGHT

CAUTION:

If the oil pressure warning light stays on while the engine is running, serious engine damage may result. The oil pressure warning light comes on whenever there is insufficient oil pressure. In normal operation, it should come on when the ignition switch is turned on, then go out when the engine is started. If the oil pressure warning light stays on while the engine is running, there is a serious malfunction.

If this happens, stop the car as soon as it is safe to do so, turn off the engine and check the oil level. If the oil level is low, add engine oil to the proper level and start the engine again. If the light stays on with the engine running, turn the engine off immediately. In any instance where the oil light stays on when the engine is running, the engine should be checked by a Hyundai dealer before the car is driven again.

ZB110L1-A

PARKING BRAKE/BRAKE FLUID LEVEL WARNING LIGHT

CAUTION:

If you suspect brake trouble, have your brakes checked by a Hyundai dealer as soon as possible. Driving your car with a problem in either the brake electrical system or brake hydraulic system is dangerous, and could result in serious injury or death.

Warning Light Operation

The parking brake/brake fluid level warning light should come on when the parking brake is applied and the ignition switch is turned to "ON" or "START". After the engine is started, the light should go out when the parking brake is released.

If the parking brake is not applied, the warning light should come on when the ignition switch is turned to "ON" or "START", then go out when the engine starts. If the light comes on at any other time, you should slow the vehicle and bring it to a complete stop in a safe location off the roadway.

The brake warning light indicates that the brake fluid level in the brake master cylinder is low and brake fluid conforming to DOT 3 specifications should be added. After adding fluid, if no other trouble is found, the car should be immediately and carefully driven to a Hyundai dealer for inspection. If further trouble is experienced, the

FEATURES OF YOUR HYUNDAI

vehicle should not be driven at all but taken to a dealer by a professional towing service.

Your Hyundai is equipped with dual-diagonal braking systems. This means you still have braking on two wheels even if one of the dual systems should fail. With only one of the dual systems working, more than normal pedal travel and greater pedal pressure are required to stop the car. Also, the car will not stop in as short a distance with only a portion of the brake system working. If the brakes fail while you are driving, shift to a lower gear for additional engine braking and stop the car as soon as it is safe to do so.

ZB110M1-A

CHARGING SYSTEM WARNING LIGHT

The charging system warning light should come on when the ignition is turned on, then go out when the engine is running. If the light stays on while the engine is running, there is a malfunction in the electrical charging system. If the light comes on while you are driving, stop, turn off the engine and check under the hood. First, make certain the generator drive belt is in place. If it is, check the tension of the belt. Do this as shown on page 6-15 by pushing down on the center of the belt.

YB640A2-A

ABS SERVICE REMINDER INDICATOR (SRI)

When the key is turned to the "ON" position, the ABS SRI will come on and then go off in a few seconds.

1- 22

If the ABS SRI remains on, comes on while driving, or does not come on when the key is turned to the "ON" position, this indicates that there may be a problem with the ABS.

If this occurs, have your vehicle checked by your Hyundai dealer as soon as possible. The normal braking system will still be operational, but without the assistance of the anti-lock brake system.

ZB110O1-A

DOOR AJAR WARNING LIGHT AND CHIME

The door ajar warning light and chime warns you that a door is not completely closed.

NOTE:

To remind you not to lock the key inside the car, the warning chime sounds and the warning light comes on whenever the key is in the "LOCK" position and the door is open. The chime sounds and the light remains on until the key is removed from the ignition.

ZB110P1-A

LOW FUEL LEVEL WARNING LIGHT

The low fuel level warning light comes on when the fuel tank is approaching empty. When it comes on, you should add fuel as soon as possible. Driving with the fuel level warning light on or with the fuel level below "E" can cause the engine to misfire and damage the catalytic converter.

AB110Q1-A

MALFUNCTION INDICATOR LAMP (MIL)

This lamp illuminates when there is a malfunction of an exhaust gas related component, and the system is not functioning properly. This lamp will also illuminate when the ignition key is turned to the "ON" position, and then it will go out in a few seconds. If it illuminates while driving, or does not illuminate when the ignition key is turned to the "ON" position, take your car to your nearest authorized Hyundai dealer and have the system checked.

ZB110R1-A

BRAKE PAD WEAR INDICATOR

The front disc brake pads have wear indicators that should make a high-pitched squealing or scraping noise when new pads are needed. The sound may come and go or be heard all the time when the vehicle is moving. It may also be heard when the brake pedal is pushed down firmly. Expensive rotor damage will result if the worn pads are not replaced. See your Hyundai dealer immediately.

FEATURES OF YOUR HYUNDAI

YB110C1-A

AIR
BAG

Supplemental Restraint System (SRS) Service Reminder Indicator (SRI)

The SRS service reminder indicator (SRI) comes on and flashes for about 6 seconds after the ignition key is turned to the "ON" position or after the engine is started, after which it will go out.

This light also comes on when the SRS is not working properly. If the SRI does not come on, or continuously remains on after flashing for about 6 seconds when you turned the ignition key to the "ON" position or started the engine, or if it comes on while driving, have the SRS inspected by an authorized Hyundai Dealer.

ZB110S1-A

FUEL GAUGE

The needle on the gauge indicates the approximate fuel level in the fuel tank. The fuel capacity is given in Section 9.

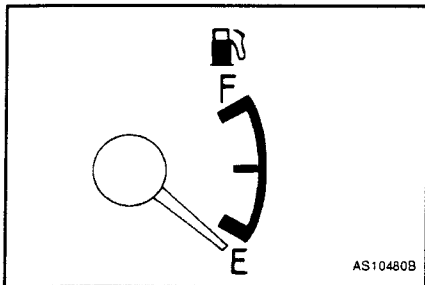

ZB110T1-A

ENGINE COOLANT TEMPERATURE GAUGE

WARNING

Never remove the radiator cap when the engine is hot. The engine coolant is under pressure and could erupt and cause severe burns. Wait until the engine is cool before removing the radiator cap.

The needle on the engine coolant temperature gauge should stay in the normal range. If it moves across the dial to "H" (Hot), pull over and stop as soon as possible and turn off the engine. Then open the hood and check the engine coolant level in the plastic tank at the right side of the engine compartment.

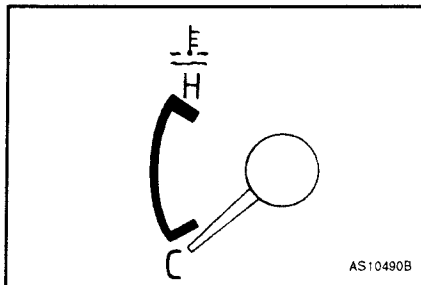

ZB110U1-A

SPEEDOMETER

Your Hyundai's speedometer is calibrated in miles per hour (on the outer scale) and kilometers per hour (on the inner scale)

ZB110V1-A

ODOMETER

The odometer records the total distance traveled in miles and tenths of a mile. You will also find the odometer useful to determine when periodic maintenance should be performed.

NOTE:

Federal law forbids tampering with the odometer of any vehicle with the intent to change the mileage. Tampering with the odometer may void your warranty coverage.

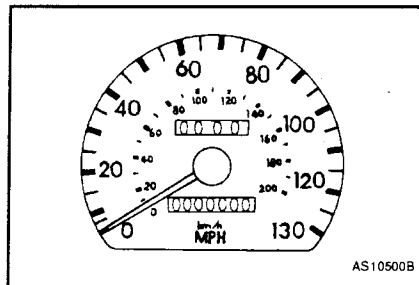

FEATURES OF YOUR HYUNDAI

ZB110W1-A

TRIP ODOMETER

The trip odometer records distance in miles and tenths of a mile. It is equipped with a push-button reset feature. This allows you to return the trip odometer to zero by pushing in on the small knob beside the speedometer.

ZB110X1-A

TACHOMETER (If installed)

The tachometer registers the speed of your engine in revolutions per minute (rpm). It is useful to help you shift at the appropriate engine speed to avoid lugging or over-revving the engine.

CAUTION:

The engine should not be raced to such a speed that the needle enters the red zone on the tachometer face. This can cause severe engine damage and may void your warranty.

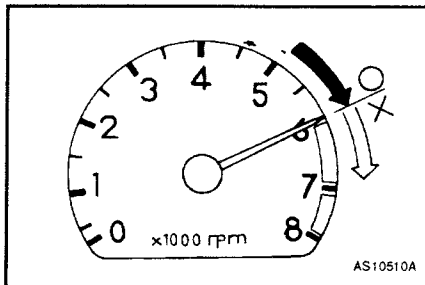

ZB120A1-A

COMBINATION TURN SIGNAL, HEADLIGHT AND LOW-BEAM SWITCH

Turn Signal Operation

Pulling down on the lever causes the turn signals on the left side of the car to blink. Pushing upward on the lever causes the turn signals on the right side of the car to blink. As the turn is completed, the lever will automatically return to the center position and turn off the turn signals at the same time. If either turn signal indicator light blinks more rapidly than usual, goes on but does not blink, or does not go on at all, there is a malfunction in the system. Check for a burned-out fuse or bulb or see your Hyundai dealer.

ZB120B1-A

Lane Change Signal

To indicate a lane change, move the lever up or down to a point where it begins flashing.

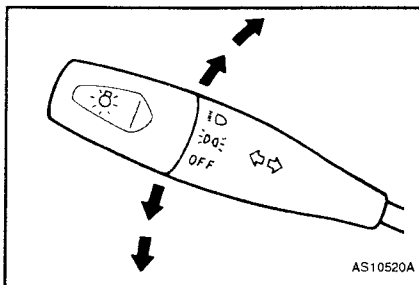

The lever will automatically return to the center position when released.

ZB120C1-A

HEADLIGHT SWITCH

To operate the headlights, turn the barrel on the end of the multi-function switch. The first position turns on the parking lights, sidelights, tail lights and instrument panel lights. The second position turns on the headlights.

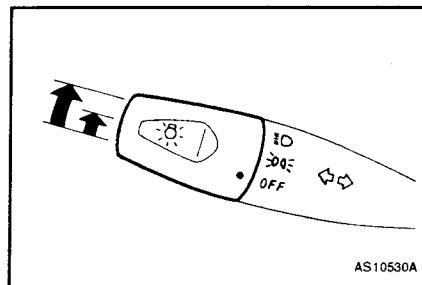

FEATURES OF YOUR HYUNDAI

ZB120D1-A

HIGH-BEAM SWITCH

To turn on the headlight high beams, push the lever forward (away from you). The High Beam Indicator Light will come on at the same time. For low beams, pull the lever back toward you.

ZB120E1-A

HEADLIGHT FLASHER

To flash the headlights, pull the lever toward you, then release it. The headlights can be flashed even though the headlight switch is in the "OFF" position.

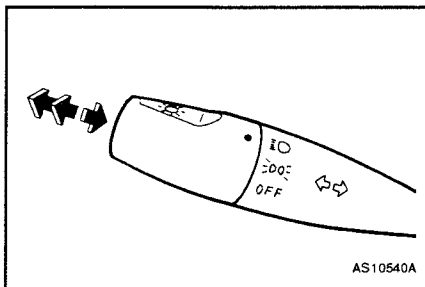

ZB130A1-A

WINDSHIELD WIPER AND WASHER SWITCH

The windshield wiper switch has three positions:

1. Intermittent wiper operation
2. Low-speed operation
3. High-speed operation

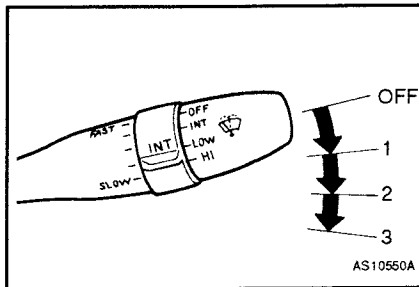

YB130B1-B

WINDSHIELD WASHER OPERATION

To use the windshield washer, pull the wiper/washer lever toward the steering wheel. When the washer lever is operated, the wipers automatically make two passes across the windshield. The washer continues to operate until the lever is released.

NOTE:

- o Do not operate the washer more than 15 seconds at a time or when the fluid reservoir is empty.
- o In icy or freezing weather, be sure the wiper blades are not frozen to the glass prior to operating the wipers.
- o In areas where water freezes in winter, use windshield washer antifreeze.

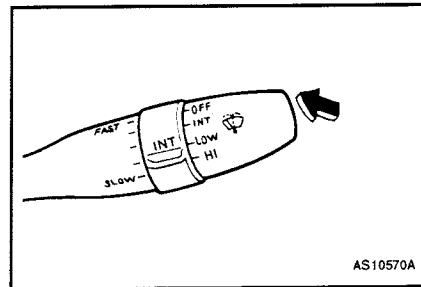

FEATURES OF YOUR HYUNDAI

AB140A1-A

ADJUSTABLE INTERMITTENT WIPER OPERATION (If installed)

To use the intermittent wiper feature, place the wiper switch in the "INT" position. With the switch in this position, the interval between wipes can be varied in 5 positions by turning the Interval Adjuster Switch.

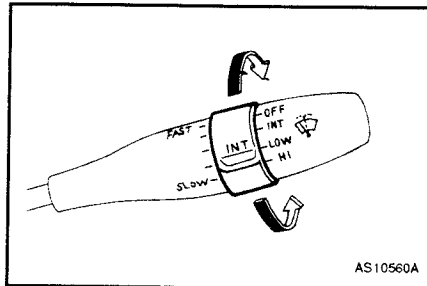

ZB150A1-A

REAR WINDOW WIPER AND WASHER (If installed)

The rear wiper is turned on by pushing in on the switch. Washer fluid is sprayed onto the glass as long as the switch is depressed. Do not operate the washer continuously for more than 20 seconds or when the fluid reservoir is empty; this could damage the system.

Do not operate the wiper when the window is dry; this can result in scratching as well as premature wiper blade wear. For the same reason, do not operate the washer when the washer fluid reservoir is empty.

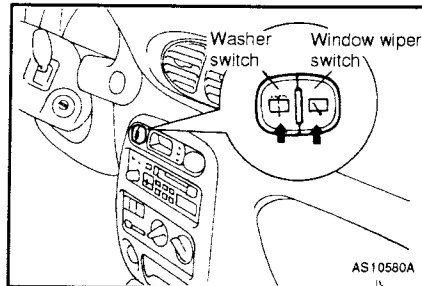

AB160A1-A

HAZARD WARNING SYSTEM

The hazard warning system should be used whenever you find it necessary to stop the car in a hazardous location. When you must make such an emergency stop, always pull off the roadway as far as possible.

To turn on the hazard warning lights, push the hazard switch. This causes all turn signal lights to blink. The hazard warning lights will operate even though the key is not in the ignition. To turn off the hazard warning lights, push the hazard switch.

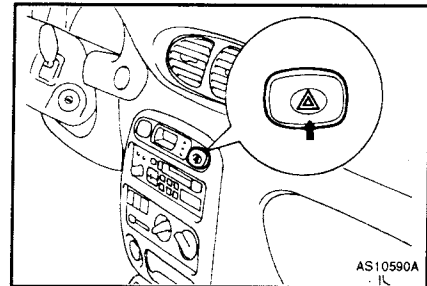

FEATURES OF YOUR HYUNDAI

AB170A1-A

REAR WINDOW DEFROSTER SWITCH

The rear window defroster is turned on by pushing in on the switch. To turn the defroster off, push in on the switch a second time. The rear window defroster automatically turns itself off after about 15 minutes. To restart the defroster cycle, push in on the switch again after it has turned itself off.

CAUTION:

Do not clean the inner side of the rear window glass with an abrasive type of glass cleaner or use a scraper to remove the foreign deposits from the inner surface of the glass as this may cause damage to the defroster elements.

NOTE:

The engine must be running for the rear grid defroster to operate.

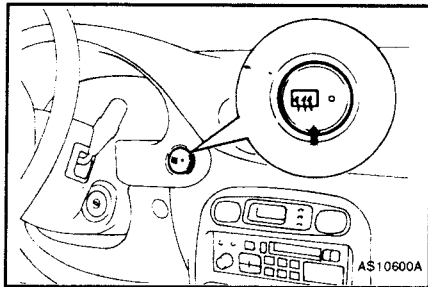

ZB190A1-A

DIGITAL CLOCK (If installed)

There are three control buttons for the digital clock. Their functions are:

HOUR - Push "H" to advance the hour indicated.

MIN - Push "M" to advance the minute indicated.

RESET - Push "R" to reset minutes to ":00" to facilitate resetting the clock to the correct time. When this is done:

Pressing "R" between 10 : 30 and 11 : 29 changes the readout to 11 : 00. Pressing "R" between 11 : 30 and 12 : 29 changes the readout to 12 : 00.

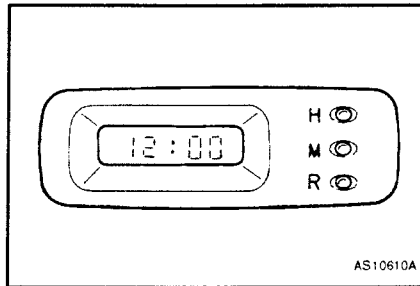

AB900B1-A

FRONT FOG LIGHT SWITCH (If installed)

To turn on the front fog lights, push the switch. They will come on when the headlight switch is in the first or second position and the key is in the "ON" position.

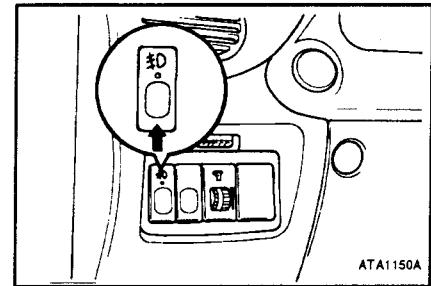

FEATURES OF YOUR HYUNDAI

ZB200A1-A

INSTRUMENT PANEL LIGHT CONTROL (RHEOSTAT)

The instrument panel lights can be made brighter or dimmer by turning the instrument panel light control knob.

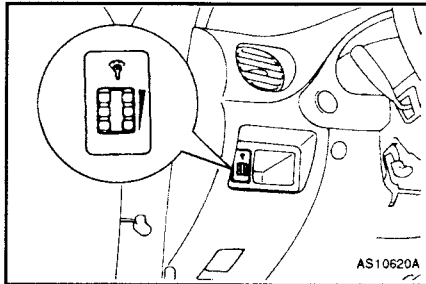

ZB210A1-A

CIGARETTE LIGHTER

For the cigarette lighter to work, the key must be in the "ACC" position or the "ON" position.

To use the cigarette lighter, push it all the way into its socket. When the element has heated, the lighter will pop out to the "ready" position.

Do not hold the cigarette lighter pressed in. This can damage the heating element and create a fire hazard.

If it is necessary to replace the cigarette lighter, use only a genuine Hyundai replacement or its approved equivalent.

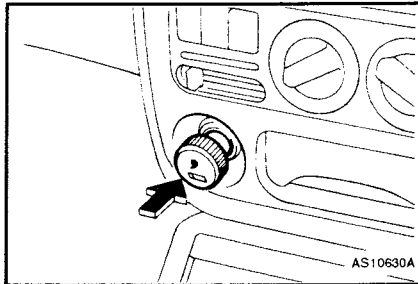

ZB220A1-A

FRONT ASHTRAY

The front ashtray may be opened by pulling it out by its bottom edge. To remove the ashtray to empty or clean it, press down on the spring-loaded tab inside the ashtray and pull it all the way out. The ashtray lamp will only illuminate when the external lights are on.

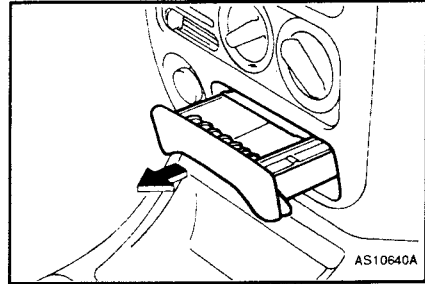

FEATURES OF YOUR HYUNDAI

AB220B1-A

REAR ASHTRAY (If installed)

The rear ashtray may be opened by pulling it out by its top edge. To remove the ashtray to empty or clean it, lift the ashtray outward and up at the top edge.

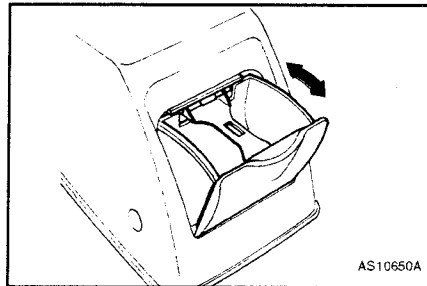

AB230A1-A

DRINK HOLDER (If installed)

The drink holder is located on the front main console for holding a cup or can. The drink holder can be used by pulling out on the slider handle.

CAUTION:

Place the drink holder in its original position while not in use.

WARNING

Do not place anything else on the drink holder. Such objects can be thrown out, possibly injuring persons in the vehicle during sudden braking or in an accident.

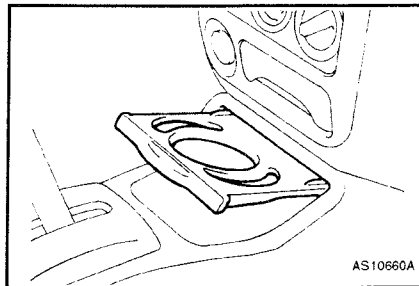

AB240A1-A

SUNSHADE (If installed)

To remove the sunshade

1. Pull the sunshade knob toward the front of the sunshade then pull down the rear of the sunshade.
2. Then, you can easily remove the sunshade.

To install the sunshade

1. Install the hook into the holder attached on the front of the sunroof.
2. Slide and lock the sunshade into the catch.

WARNING

Never install or remove the sunshade while driving.

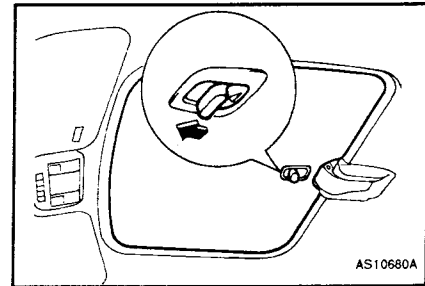

FEATURES OF YOUR HYUNDAI

CAUTION:

- o Installation or removal of the sunshade should be done with the sunroof closed.
- o Before driving, make sure the sunshade is securely installed.

AB240B1-A

SUNROOF (If installed)

To tilt up the sunroof

The sunroof can be manually opened or closed.

1. Pull the handle down and then forward and up as indicated by the arrows in the illustration below.
2. Push the handle at the center to lock the sunroof in the open position.
3. After tilting up the sunroof, make sure the handle is secure in place.

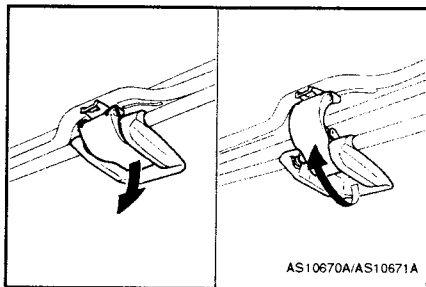

AB240C1-A

To close the sunroof

1. Pull the handle toward you.
2. After the sunroof has been closed, lock the handle back into position.
3. Be sure that the sunroof and handle are securely closed.

WARNING

Do not close the sunroof if anyone's hands, arms or other body parts are between the sunroof and the sunroof sash as this may cause an injury.

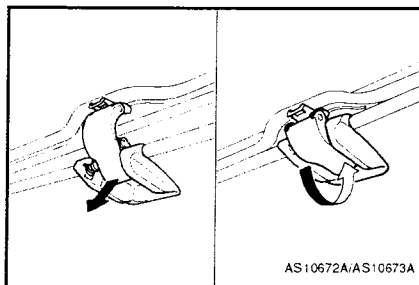

CAUTION:

- o Do not open the sunroof in severely cold temperatures or when it is covered with ice or snow.
- o Periodically remove any dirt that may have accumulated on the guide rails.
- o Remove water drops, snow, ice or sand from the sunroof before opening.

AB240D1-A

To remove the sunroof

1. Remove the sunshade before removing the sunroof.
2. Pull the handle all the way downward.
3. Depress the handles of the base plate to release them from their holes.
4. Raise the sunroof glass from outside of the vehicle until it is perpendicular to the roof panel.

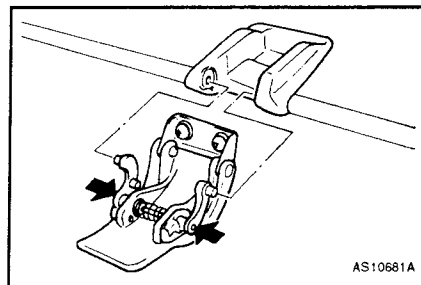

FEATURES OF YOUR HYUNDAI

5. Now, you can easily remove the sunroof from the roof panel.

WARNING

- o Do not stand up or extend any portion of your body out of the opening while the vehicle is moving.
- o Do not sit on top of the vehicle around the opening

AB240E1-A

To install the sunroof

1. Insert the flat hinges into the cutouts. Then supporting the sunroof with your hands, slowly lower it.
2. Make sure both of the flat hinges are securely inserted into their cutouts.
3. Depress the handles of the base plate and insert into the holes.

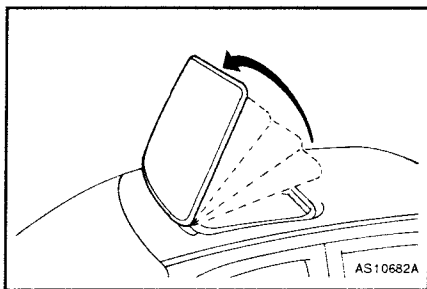

WARNING

- o Never install or remove the sunroof while driving.
- o Never put your hands between the sunroof and the body.
- o Do not drive the vehicle without being certain that the sunroof is securely locked in place.

AB240F1-A

Storing the sunroof and the sunshade

There is a storage bag in the trunk. Place the sunroof or sunshade into the storage bag and store it in the trunk.

CAUTION:

- o Be careful not to place heavy objects on the bag, otherwise the sunshade or sunroof may be deformed or broken.
- o When storing the sunroof and sunshade into the storage bag, put the sunshade on top of the sunroof.

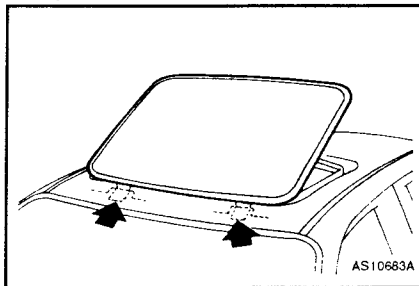

DB250A2-A

INTERIOR LIGHT (With sunroof)

The interior courtesy light has a 3-position switch. The three positions are:

- o "●" In the "MIDDLE" position, the interior courtesy light comes on when any door is opened, then goes out when it is closed.
- o "OFF" In the "RIGHT" position, the light stays off even though a door is open.
- o "ON" In the "LEFT" position, the light stays on at all times.

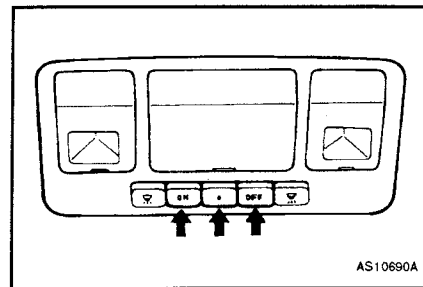

FEATURES OF YOUR HYUNDAI

ZB25051-A

INTERIOR LIGHT (Without sunroof)

The interior courtesy light has a 3-position switch. The three positions are:

- o "DR" In the "MIDDLE" position, the interior courtesy light comes on when any door is opened, then goes out when it is closed.
- o "OFF" In the "LEFT" position, the light stays off even though a door is open.
- o "ON" In the "RIGHT" position, the light stays on at all times.

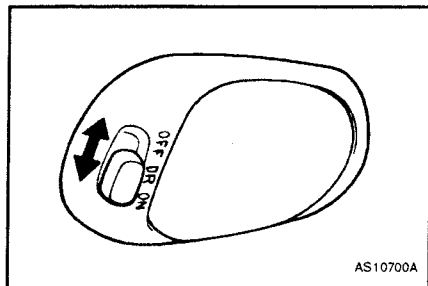

AB260A1-A

GLOVE BOX

WARNING

To avoid the possibility of injury in case of accident or a sudden stop, the glove box door should be kept closed when the car is in motion.

- o To open the glove box, pull on the glove box release lever.

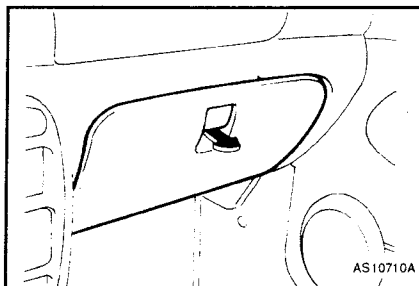

AB270A1-A

OUTSIDE REAR VIEW MIRROR (Lever type)

The outside rear view mirror is equipped with a remote control for your convenience. It is operated by the control lever in the bottom front corner of the window.

Before driving away, always check that your mirror is positioned so you can see directly behind you. When using the mirror, always exercise caution when attempting to judge the distance of vehicles behind you.

CAUTION:

If the mirror control is jammed with ice, do not attempt to break it free using the control handle or by manipulating the face of the mirror. Use an approved spray de-icer (not radiator antifreeze) to release the frozen mechanism or move the vehicle to a warm place and allow the ice to melt.

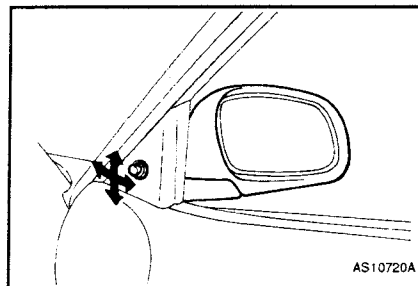

FEATURES OF YOUR HYUNDAI

AB270B1-A

Electric Type (If installed)

The outside rear-view mirror can be adjusted in any direction to give the maximum rear view vision.

The remote control outside rear-view mirror switch controls the adjustments for both right and left door mirrors.

To adjust the position of either mirror:

1. Move the selecting switch to the right or left to activate the adjustable mechanism for the corresponding door mirror.
2. Now, adjust mirror angle by depressing the appropriate perimeter switch as illustrated.

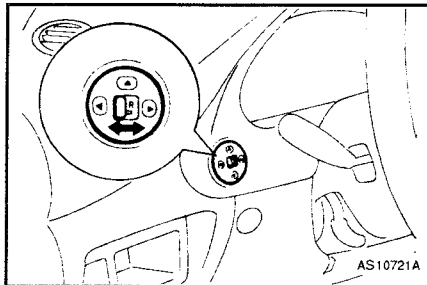

CAUTION:

- o Do not operate the switch continuously for an unnecessary length of time.
- o Scraping ice from the mirror face could cause permanent damage. To remove any ice, use a sponge, soft cloth or approved de-icer.

WARNING

Be careful when judging the size or distance of any object seen in the passenger side rear view mirror. It is a convex mirror with a curved surface. Objects seen in this mirror are closer than they appear.

AB270D1-A

FOLDING THE OUTSIDE REAR VIEW MIRRORS

To fold the outside rear view mirrors, push them towards the rear.

The outside rear view mirrors can be folded rearward for parking in restricted areas.

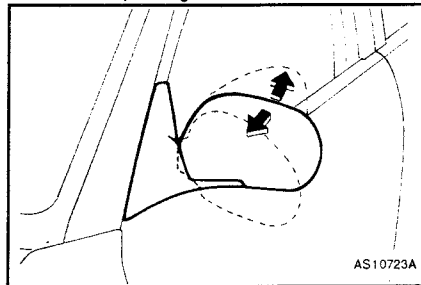

WARNING

Do not adjust or fold it while the vehicle moving.

This could result in loss of control, and an accident causing death, serious injury, or property damage.

ZB260A1-A

DAY/NIGHT REAR VIEW MIRROR

Your Hyundai is equipped with a day/night inside rear view mirror. The "night" position is selected by flipping the tab at the bottom of the mirror toward you. In the "night" position, the glare of headlights of cars behind you is reduced.

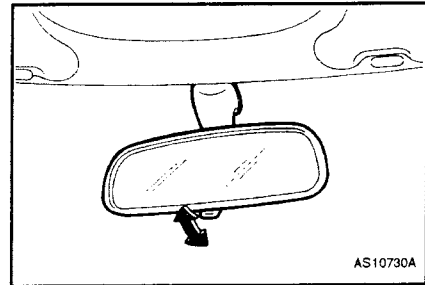

FEATURES OF YOUR HYUNDAI

ZB290A1-A

PARKING BRAKE

Always engage the parking brake before leaving the car. This also turns on the parking brake indicator light when the key is in the "ON" position. Before driving away, be sure that the parking brake is fully released and the indicator light is off.

- o To engage the parking brake, pull the lever up as far as possible.
- o To release the parking brake, pull up and press the thumb button. Then, while holding the button in, lower the brake lever.

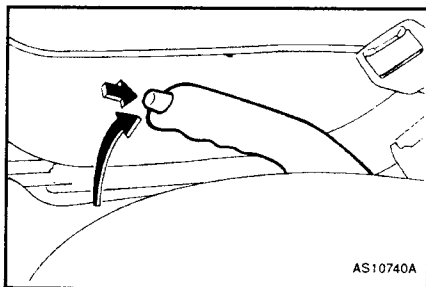

ZB300A2-A

FOLD DOWN REAR SEATBACKS (If installed)

WARNING

The purpose of the fold-down rear seat backs is to allow you to carry longer objects than could otherwise be accommodated. Do not allow passengers to sit on top of the folded-down seat back while the car is moving as this is not a proper seating position and no seat belts are available for use when the seat backs are folded down. This could result in serious injury or death in case of an accident or sudden stop. Objects carried on the folded-down seatback should not extend higher than the top of the front seats. This could allow cargo to slide forward and cause injury or damage during sudden stops.

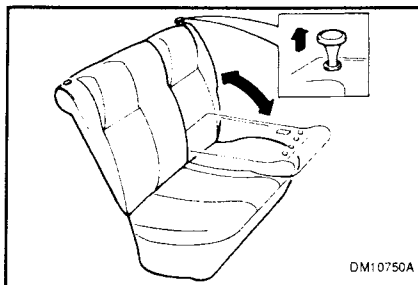

For greater convenience, the entire seatback may be folded down or the seatbacks may be folded down individually.

- o To unlock the seatback, pull up on the seatback locking knob, then pull forward on the seatback.
- o When you return the seatback to its upright position, always be sure it has locked into position by pulling and pushing on the top of the seatback.

WARNING

When you return the rear seatback to its upright position after being folded down, be careful not to damage the seat belt webbing or buckle. In addition, do not allow the seat belt webbing or buckle to get caught or pinched in the rear seat.

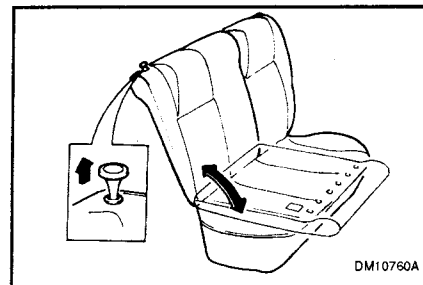

FEATURES OF YOUR HYUNDAI

ZB310A1-A

HATCHBACK DOOR/TRUNK LID

WARNING

The hatchback door or trunk lid should always be kept completely closed while the vehicle is in motion. If it is left open or ajar, poisonous exhaust gases may enter the car resulting in serious injury or death to the occupants. See additional warnings concerning exhaust gases on page 2-2.

- o The hatchback door or trunk lid is opened by first turning the key clockwise to release the lock, then raising the door manually.
- o To close, lower the door or lid, then press down on it until it locks. To be sure the door or lid is securely fastened, always try to pull it up again.

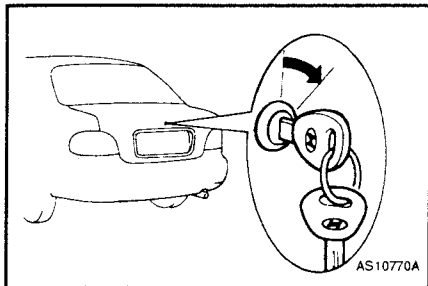

ZB320A1-A

CARGO AREA COVER (3 Door Model)

WARNING

Nothing should be carried on top of the cargo area cover. Loose materials could result in injury to vehicle occupants during sudden braking.

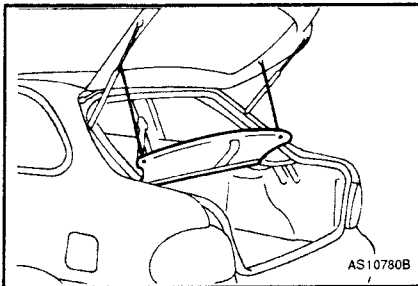

AB330A1-A

REMOTE HATCHBACK DOOR/TRUNK LID RELEASE (If installed)

The hatchback door or trunk lid is opened by pulling the lever to release the lock, then raising the door or lid manually.

To close, lower the door or lid, then press down on it until it locks. To be sure the door or lid is securely fastened, always try to pull it up again.

WARNING

The hatchback door or trunk lid should always be kept completely closed while the vehicle is in motion.

If it is left open or ajar, exhaust gases may enter the car and serious illness may result.

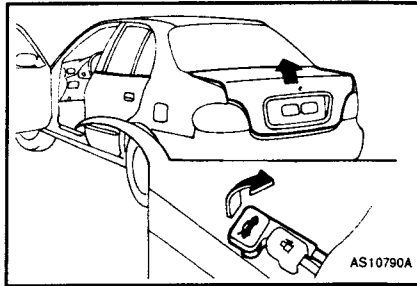

FEATURES OF YOUR HYUNDAI

ZB340A1-A

HIGH-MOUNTED REAR STOPLIGHT

In addition to the lower-mounted rear stoplights on either side of the car, the high mounted rear stop light in the center of the rear window also comes on when the brakes are applied.

JB360A1-A

REMOTE FUEL-FILLER LID RELEASE

The fuel-filler lid may be opened from inside the vehicle by pulling up on the fuel-filler lid opener located on the front floor area on the left side of the car.

NOTE:

If the fuel-filler lid will not open because ice has formed around it, tap lightly or push on the lid to break the ice and release the lid. Do not pry on the lid. If necessary, spray around the lid with an approved de-icer fluid (do not use radiator anti-freeze) or move the vehicle to a warm place and allow the ice to melt.

WARNING

Gasoline vapors are dangerous. Before refueling, always stop the engine and never allow sparks or open flames near the filler area. If you need to replace the filler cap, use a genuine Hyundai replacement part.

If you open the fuel filler cap during high ambient temperatures, a slight "pressure sound" may be heard. This is normal and not a cause for concern.

Whenever you open the fuel filler cap, turn it slowly.

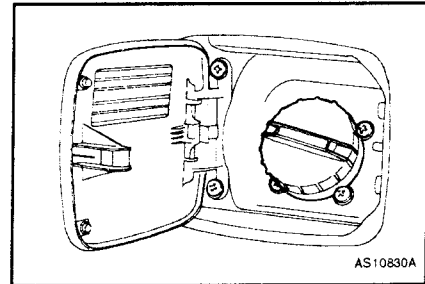
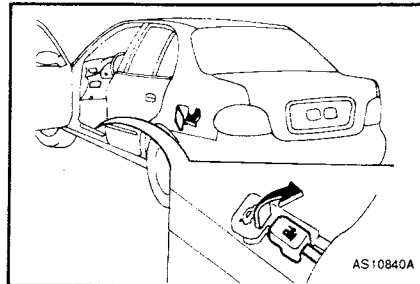
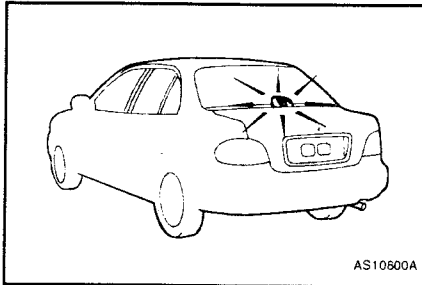

FEATURES OF YOUR HYUNDAI

DB370A1-A

HOOD RELEASE

1. Pull the release knob to unlatch the hood.
2. Press the safety catch lever up and lift the hood.
3. Hold the hood open with the support rod.

Before closing the hood, return the support rod to its clip to prevent it from rattling. Lower the hood until it is about 1 ft. (30 cm) above the closed position and let it drop. Make sure that it locks into place.

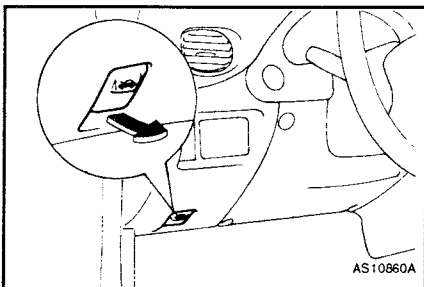

CAUTION:

Make sure that the support rod has been released prior to closing the hood. Always double check to be sure that the hood is firmly latched before driving away. If it is not latched, the hood could fly open while the vehicle is being driven, causing a total loss of visibility, which might result in an accident. The support rod must be inserted completely into the hole provided in the hood whenever you inspect the engine compartment. This will prevent the hood from falling and possibly injuring you. Do not move the vehicle with the hood in the raised position, as vision is obstructed and the hood could fall or be damaged.

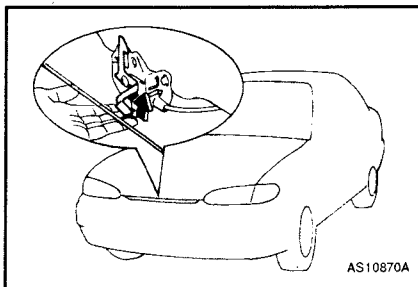

AB380A1-A

SUN-VISOR

Your Hyundai is equipped with sun visors to give the driver and front passenger either frontal or sideward shade. The sun visors are fitted on both sides on all models. To reduce glare or to shut out direct rays of the sun, turn the sun visor down to block the annoyance.

A vanity mirror is provided on the back of the sun visor for the front passenger.

NOTE:

The Supplemental Restraint System (SRS) label containing useful information can be found on the back of each sun visor.

CAUTION:

Do not place the sun visor in such a manner that it obscures visibility of the roadway, traffic or other objects.

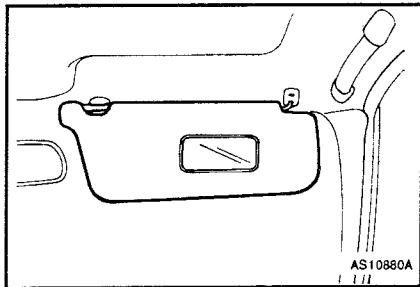

FEATURES OF YOUR HYUNDAI

AB390A1-A

STEERING WHEEL TILT LEVER (If installed)

To adjust the steering wheel:

1. Push the lever downward to unlock.
2. Raise or lower the steering wheel to the desired position.
3. After adjustment, securely tighten the lever by pulling it upward.

WARNING

Do not attempt to adjust the steering wheel while driving as this may result in loss of control of the vehicle and serious injury or death.

AB420A1-A

HORN

Press either of the side buttons on the steering wheel to sound the horn.

AB440A1-A

HEATING AND VENTILATION ROTARY TYPE (If installed)

This model has four controls for the heating and cooling system. They are:

1. Fan speed control
2. Air flow control
3. Temperature control
4. Air intake control

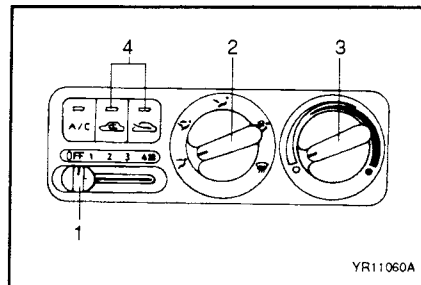
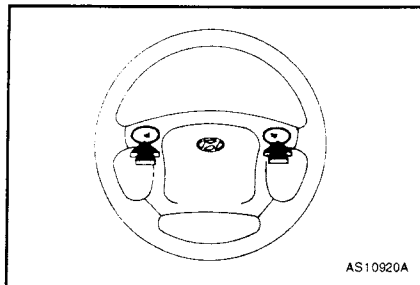
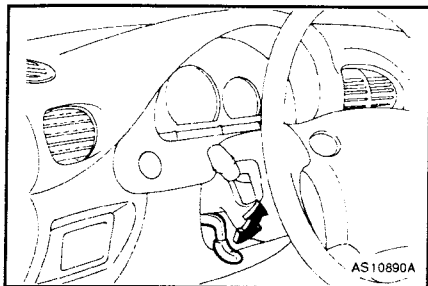

FEATURES OF YOUR HYUNDAI

ZB440B1-A

FAN SPEED CONTROL (BLOWER CONTROL)

This is used to turn the blower fan on and off and to select the fan speed.

The blower fan speed, and therefore the volume of air delivered from the system, may be controlled manually by setting the blower control between the "1" and "4" position.

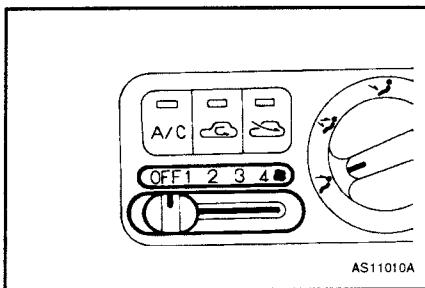

ZB440C1-A

AIR INTAKE CONTROL

This is used to select fresh outside air or recirculation inside air.

 Fresh

 Recirculation

With the "fresh" mode selected, air enters the vehicle from outside and is heated or cooled according to the other functions selected.

With the "recirc" mode selected, air from within the passenger compartment is drawn through the heating system and heated or cooled according to the other functions selected.

NOTE:

It should be noted that prolonged operation of the heating system in "recirc" mode will give rise to misting of the windshield and side

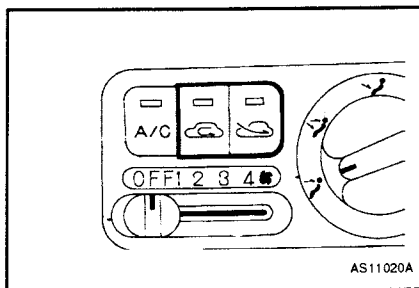

windows and the air within the passenger compartment becoming stale. In addition prolonged use of the air conditioning with the "Recirculate" mode selected may result in the air within the passenger compartment becoming excessively dry.

ZB440D1-A

AIR FLOW CONTROL

This is used to direct the flow of air. Air can be directed to the floor, dashboard outlets, or windshield. Five symbols are used to represent Face, Bi-Level, Floor, Floor-Defrost and Defrost air position.

 Face-Level

Selecting the "Face" mode will cause air to be discharged through the face level vents.

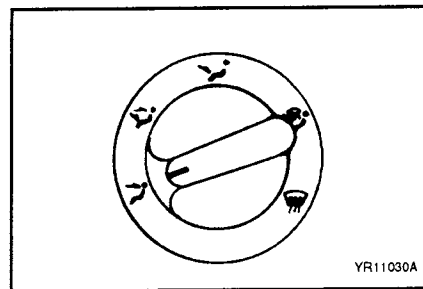

FEATURES OF YOUR HYUNDAI



Bi-Level

Air is discharged through the face vents and the floor vents. This makes it possible to have cooler air from the dashboard vents and warmer air from the floor outlets at the same time.



Floor-Level

Air is discharged through the floor vents.



Floor-Defrost Level

Air is discharged through the windshield defrost vents and the floor vents.



Defrost-Level

Air is discharged through the windshield defrost vents.

ZB440E1-A

TEMPERATURE CONTROL

This is used to turn the heating system on and off and to select the degree of heating desired.

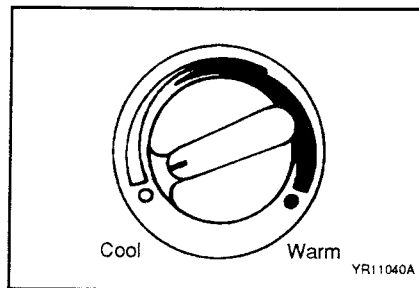

ZB430A1-A

HEATING AND VENTILATION LEVER TYPE (If installed)

There are four controls for the heating and cooling system. They are:

1. Fan Speed Control.
This is used to turn the fan on and select the fan speed.
2. Air Flow Control.
This is used to direct the flow of air. Air can be directed to the floor, dashboard outlets, or windshield. Five symbols are used to represent Face, Bi-Level, Floor, Floor-Defrost and Defrost air positions.
3. Air Intake Control.
This allows you to select fresh outside air or to circulate inside air.
4. Temperature Control.
This is used to turn the heating system on and off and to select the degree of heating desired.

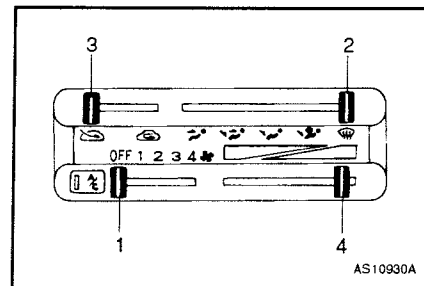

FEATURES OF YOUR HYUNDAI

ZB440B1-A

FAN SPEED CONTROL (BLOWER CONTROL)

This is used to turn the blower fan on and off and to select the fan speed.

The blower fan speed, and therefore the volume of air delivered from the system, may be controlled manually by setting the blower control between the "1" and "4" position.

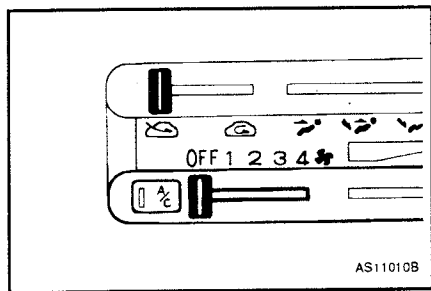

ZB440C1-A

AIR INTAKE CONTROL

This is used to select fresh outside air or recirculation inside air.

 **Fresh**

 **Recirculation**

With the "fresh" mode selected, air enters the vehicle from outside and is heated or cooled according to the other functions selected.

With the "recirc" mode selected, air from within the passenger compartment is drawn through the heating system and heated or cooled according to the other functions selected.

NOTE:

It should be noted that prolonged operation of the heating system in "recirc" mode will give rise to misting of the windshield and side windows and the air within the passenger

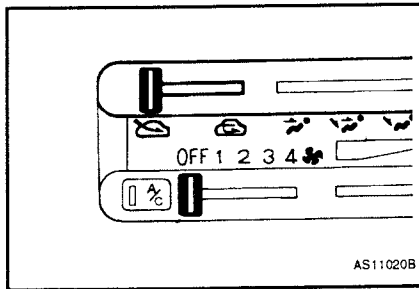

compartment becoming stale. In addition prolonged use of the air conditioning with the "Recirculate" mode selected may result in the air within the passenger compartment becoming excessively dry.

ZB440D1-A

AIR FLOW CONTROL

This is used to direct the flow of air. Air can be directed to the floor, dashboard outlets, or windshield. Five symbols are used to represent Face, Bi-Level, Floor, Floor-Defrost and Defrost air position.



Face-Level

Selecting the "Face" mode will cause air to be discharged through the face level vents.

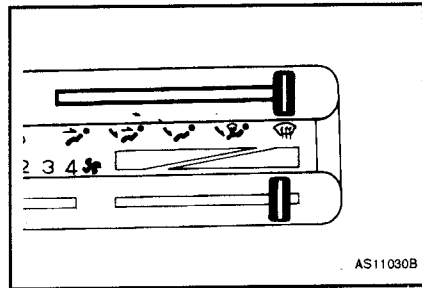

FEATURES OF YOUR HYUNDAI

Bi-Level

Air is discharged through the face vents and the floor vents. This makes it possible to have cooler air from the dashboard vents and warmer air from the floor outlets at the same time.

Floor-Level

Air is discharged through the floor vents.

Floor-Defrost Level

Air is discharged through the windshield defrost vents and the floor vents.

Defrost-Level

Air is discharged through the windshield defrost vents.

ZB440E1-A

TEMPERATURE CONTROL

This is used to turn the heating system on and off and to select the degree of heating desired.

JB430B2-A

HEATING CONTROLS

For normal heating operation, set the air intake control to the "Fresh" position and the air flow control to "Floor".

For faster heating, the air intake control should be set in the "Recirc" position.

If the windows fog up, set the air flow control to the "Def" (defroster) position and the air intake control to "Fresh".

For maximum heat, move the temperature control to "Warm".

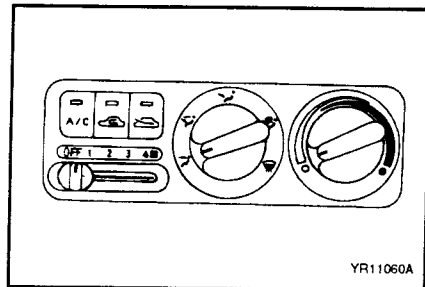
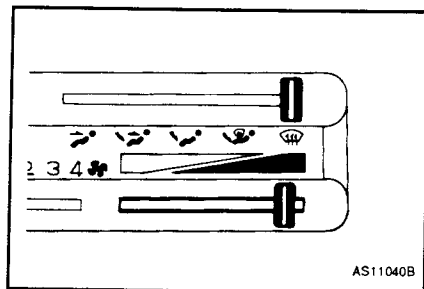

FEATURES OF YOUR HYUNDAI

ZB430C1-A

BI-LEVEL HEATING

Your Hyundai is equipped with bi-level heating controls. This makes it possible to have cooler air from the dashboard vents and warmer air from the floor outlets at the same time. To use this feature:

- o Set the air intake control to "Fresh".
- o Set the air flow control at the "Bi-Level" position.
- o Adjust the fan speed control to the desired speed.
- o Set the temperature control between "Cool" and "Warm".

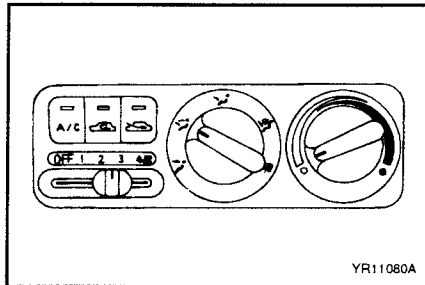

ZB430D1-A

VENTILATION

To operate the ventilation system:

- o Set the air intake control on "Fresh".
- o To direct all intake air to the dashboard vents, set the airflow control to "Face".
- o Adjust the fan speed control to the desired speed.
- o Set the temperature control between "Cool" and "Warm".

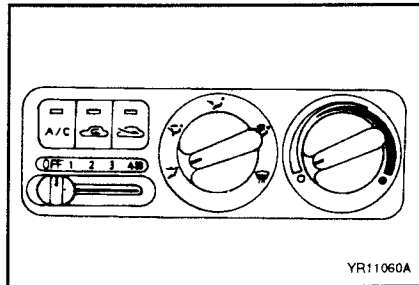

AB430E1-A

CENTER VENTILATOR

The center ventilators are located in the middle of the dashboard.

To change the direction of the airflow, turn the control knob on the middle of the ventilator as desired.

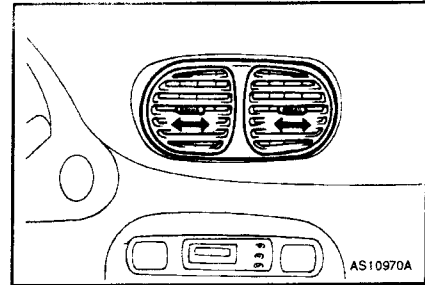

FEATURES OF YOUR HYUNDAI

AB430F1-A

SIDE VENTILATOR

The side ventilators are located on each side of the dashboard. To change the direction of the air flow, turn the control knob on the middle of the side ventilator as desired.

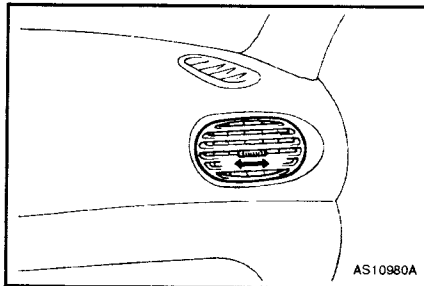

ZB430G2-A

DEFROSTING/DEFOGGING

To use the heating/ventilation system to defrost or defog the windshield:

- o Set the air intake control (3) to the "Fresh" position.
- o Set the air flow control (2) to the "Def" position.
- o Set the temperature control (4) to a comfortably warm position.
- o Set the fan speed control (1) to position 3 or 4.
- o If vehicle is so equipped, turn on the A/C for increased defogging action.

NOTE:

In high humidity areas the A/C can be used with the air intake in the "Recirc" position for increased defogging action.

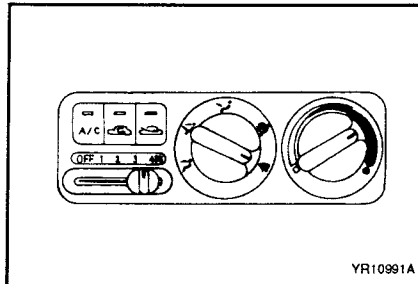

ZB430H1-A

Operation Tips

- o To keep dust or unpleasant fumes from entering the car through the ventilation system, temporarily set the air intake control at "Recirc". Be sure to return the control to "Fresh" when the irritation has passed to keep fresh air in the vehicle. This will help keep the driver alert and comfortable.
- o Air for the heating/cooling system is drawn in through the grilles just ahead of the windshield. Care should be taken that these are not blocked by leaves, snow, ice or other obstructions.

FEATURES OF YOUR HYUNDAI

ZB450A1-A

AIR CONDITIONING SWITCH (If installed)

The air conditioning is turned on by pushing the button.

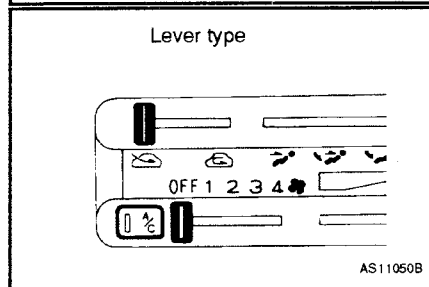
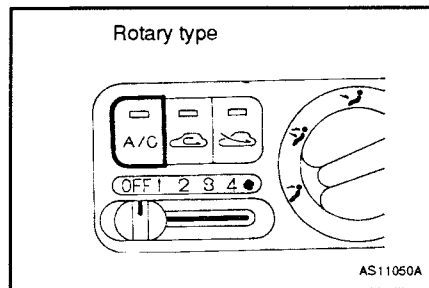

ZB450B1-A

AIR CONDITIONING OPERATION (If installed)

COOLING

To use the air conditioning to cool interior:

- o Set the side vent control to "OFF", to shut off outside air entry.
- o Turn on the fan control switch.
- o Turn on the air conditioning switch by pushing in on the switch. The air conditioning indicator light should come on at the same time.
- o Set the air intake control to "Fresh".

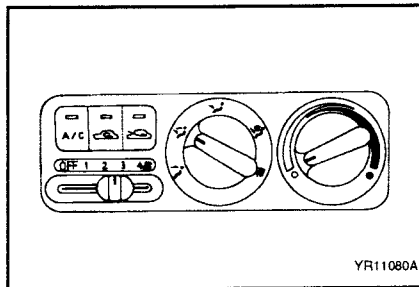

- o Set the temperature control to "Cool". ("Cool" provides maximum cooling. The temperature may be moderated by moving the control toward "Warm".)
- o Adjust the fan control to the desired speed. For greater cooling, turn the fan control to one of the higher speeds or temporarily select the "Recirc" position on the air intake control.

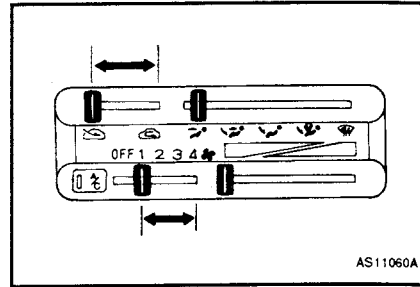

FEATURES OF YOUR HYUNDAI

ZB450C1-A

DE-HUMIDIFIED HEATING

For dehumidified heating:

- o Turn on the fan control switch.
- o Turn on the air conditioning switch. The air conditioning indicator light should come on at the same time.
- o Set the air intake control to "Fresh".
- o Set the air flow control to "Face".

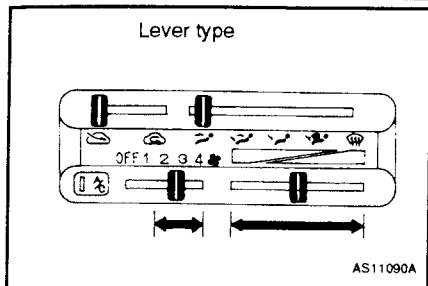
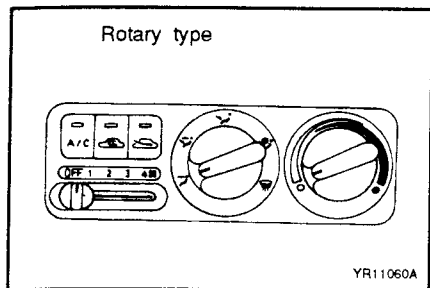

- o Adjust the fan control to the desired speed.
- o For more rapid action, set the fan at one of the higher speeds.
- o Adjust the temperature control to provide the desired amount of warmth.

ZB450D1-A

Operation Tips

- o If the interior of the car is hot when you first get in, open the windows for a few minutes to expel the hot air.
- o When you are using the air conditioning system, keep all windows closed to keep hot air out.
- o When moving slowly, as in heavy traffic, shift to a lower gear. This increases engine speed, which in turn increases the speed of the air conditioning compressor.
- o On steep grades, turn the air conditioning off to avoid the possibility of the engine overheating.
- o During winter months or in periods when the air conditioning is not used regularly, run the air conditioning once every month for a few minutes. This will help circulate the lubricants and keep your system in peak operating condition.

ZB500A1-A

STEREO SOUND SYSTEM

How Car Audio Works

AM and FM radio signals are broadcast from transmitter towers located around your city. They are intercepted by the radio antenna on your car. This signal is then received by the radio and sent to your car speakers.

When a strong radio signal has reached your vehicle, the precise engineering of your audio system ensures high quality reproduction. However, in some cases the signal coming to your vehicle is not strong and clear. This can be due to factors such as the distance from the radio station, closeness of other strong radio stations or the presence of buildings, bridges or other large obstructions in the area.

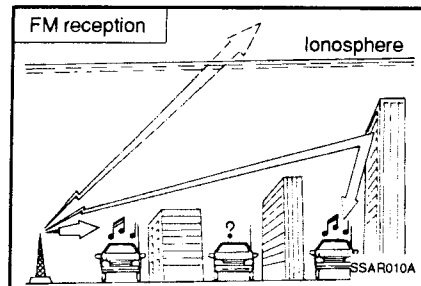

FEATURES OF YOUR HYUNDAI

AM signal reception is usually better than FM reception. This is because AM radio waves are transmitted at low frequency. These long, low frequency radio waves can follow the curvature of the earth rather than travelling straight out into the ionosphere. In addition, they curve around obstructions so that they can provide better signal coverage. Because of this, clear AM broadcasts can be received at greater distances than FM broadcasts.

FM broadcasts are transmitted at high frequency and do not bend to follow the earth's surface. Because of this, FM broadcasts generally begin to fade at short distances from the station. Also, FM signals are easily affected by buildings, mountains, or other obstructions. These can result in certain listening conditions which might lead you to believe a problem exists with your radio. The following conditions are normal and do not indicate radio trouble:

- o Fading - As your car moves away from the radio station, the signal will weaken and sound will begin to fade. When this occurs, we suggest that you select another stronger station.
- o Flutter/Static - Weak FM signals or large obstructions between the transmitter and your radio can disturb the signal causing static or fluttering noises to occur. Reducing the treble level may lessen this effect until the disturbance clears.

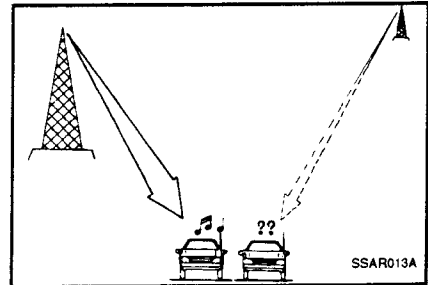
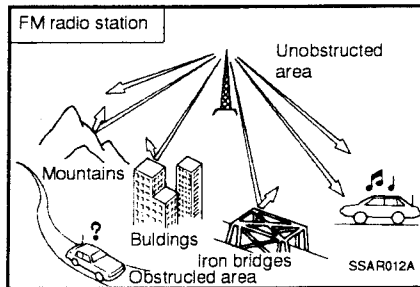
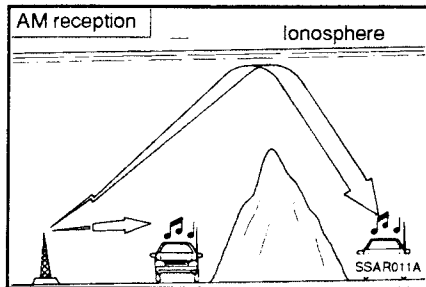

FEATURES OF YOUR HYUNDAI

- o Station Swapping - As a FM signal weakens, another more powerful signal near the same frequency may begin to play. This is because your radio is designed to lock onto the clearest signal. If this occurs, select another station with a stronger signal.
- o Multi-Path Cancellation - Radio signals being received from several directions can cause distortion or fluttering. This can be caused by a direct and a reflected signal from the same station, or by signals from two stations with close frequencies. If this occurs, select another station until the condition has passed.

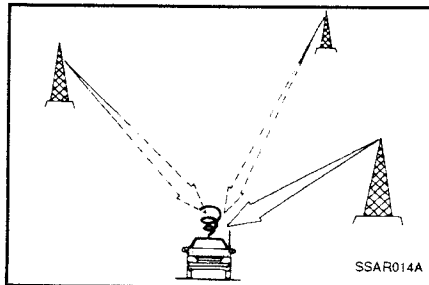

ZB500B1-A

ANTI-THEFT SYSTEM (If installed)

Setting the Anti-Theft system

To deter theft of your radio, the system is designed so that the radio unit becomes inoperable if it is stolen from the vehicle or the identification number is not input.

1. Make sure that the power switch is on, with the ignition switch in the "ACC" position. The "COdE" will be displayed on the LCD.

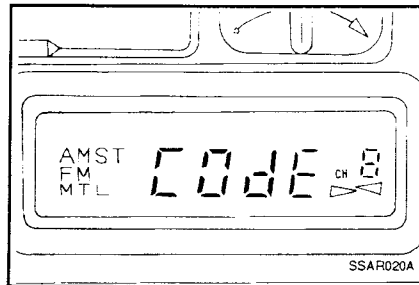

2. Input your identification number by pressing the "PRESET" buttons in sequence. If your number is 3456, press the 3 button for the first digit, the 4 button for the second digit, the 5 button for the third digit and the 6 button for the last digit.

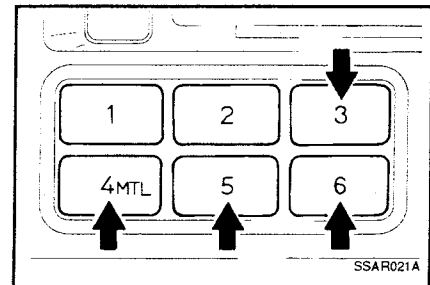

FEATURES OF YOUR HYUNDAI

NOTE:

The identification number is on the "USER CARD" that came with your Hyundai. This "USER CARD" should not be left with the radio, but in a safe place, not in the vehicle. The identification number should also be recorded in a secure place. If you need an additional "USER CARD" or if you should lose it, your authorized Hyundai dealer can make a new one.

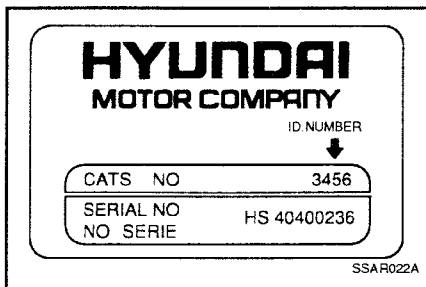

Canceling an Incorrect Identification Number

If the incorrect identification Number is input, the Anti-Theft system will activate and the radio unit will become inoperable. To correct this, press and hold the "BAND (FM/AM)" button for 3 seconds or more, until the incorrect number on the LCD disappears and "COdE" is displayed again.

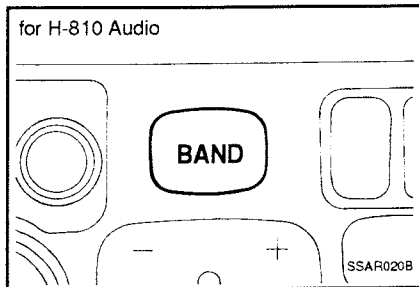

NOTE:

If an incorrect identification number is entered 3 times, it will not be possible to cancel the incorrect identification number until one hour has elapsed with the ignition switch in the "ACC" position and the radio turned on. After one hour, press and hold the "BAND (FM/AM)" button for 3 seconds or more until the incorrect number disappears and "COdE" is displayed.

NOTE:

The Anti-Theft system will be activated if the electrical power source is ever disconnected from the radio unit. If this happens, such as the battery being discharged or disconnected, see "Setting the Anti-Theft system".

Anti-Theft Indicator

The Anti-Theft indicator On/Off Control is available with the ignition key in the Off position. With the Power Switch in the Off position, press the BAND (FM/AM) button to cancel the Indicator Blinking Mode, and simply push the BAND (FM/AM) button again to re-activate the Indicator Blinking Mode again.

FEATURES OF YOUR HYUNDAI

NOTE:

If the radio will not be used for long time, the Anti-Theft Indicator Blinking Mode should be set to the Off position to save vehicle battery power.

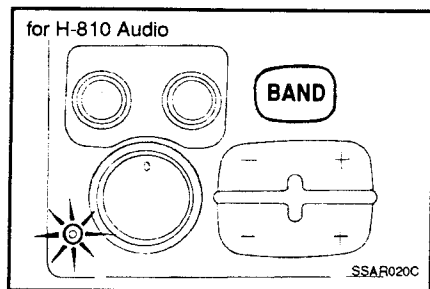

FEATURES OF YOUR HYUNDAI

DB820C1-A

STEREO RADIO OPERATION (HMR 30)

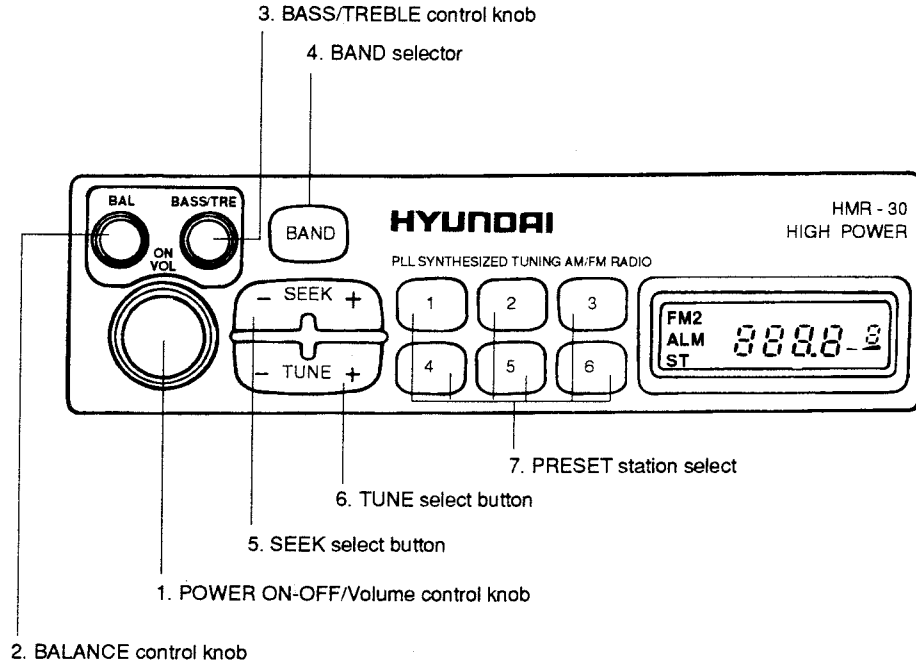

RHA0810A

FEATURES OF YOUR HYUNDAI

DB820D1-A

1. POWER ON-OFF/VOLUME CONTROL KNOB

The radio unit may be operated when the ignition key is in the "ACC" or "ON" position. Rotate the knob clockwise to switch the radio unit on, and to increase the volume, Turn the knob counterclockwise to reduce the volume, and to switch the radio unit off.

2. BALANCE Control (BAL)

Press to pop the knob out and turn it clockwise or counterclockwise until sound from the left and right speakers is about equal from your listening position.

3. BASS/TREBLE Control

Press to pop the knob out and turn to the left or right for the desired bass tone.

For FADER control, pull up the popped knob and turn to the left or right for the desired treble tone.

4. BAND Selector

Pressing the BAND button changes the AM, FM1 and FM2 bands. The mode selected is displayed on LCD.

5. SEEK Operation

(Automatic Channel Selection)

When the (+) side is pressed, the unit will automatically tune to the next higher frequency and when the (-) side is pressed, it will automatically tune the next lower frequency.

6. TUNE (Manual) Selection

Each press of the (+) side increases the frequency in 0.1 MHz steps in FM band, 9 kHz in AM Band and vice versa.

With the button held down for 0.5 sec. or more, the stop signal (broadcasting radio wave) is ignored and channel selection continues.

7. PRESET STATION SELECT

Six (6) stations for AM, FM and FM2 respectively can be preset in the electronic memory circuit on this unit.

HOW TO PRESET STATIONS

Six AM and twelve FM stations may be programmed into the memory of the radio. Then, by simply pressing the band select button and/or one of the six station select buttons, you may recall any of these stations instantly. To program the stations, follow these steps:

- o Press band selector to set the band for AM, FM and FM2.
- o Select the desired station to be stored by seek, scan or manual tuning.
- o Determine the preset station select button you wish to use to access that station.
- o Press the station select button for more than two seconds. A select button indicator will show in the display indicating which select button you have depressed. The frequency display will flash after it has been stored into the memory.
You should then release the button, and proceed to program the next desired station. A total of 18 stations can be programmed by selecting one AM and two FM stations per button.
- o When completed, any preset station may be recalled by selecting AM, FM or FM2 band and the appropriate station button.

FEATURES OF YOUR HYUNDAI

DB550C1-A

STEREO RADIO AND CASSETTE TAPE PLAYER OPERATION (H810) (If installed)

2. BALANCE/FADER CONTROL Knob (BAL/FAD)

3. BASS/TREBLE CONTROL Knob (BASS/TRE)

7. BAND Selector

8. TAPE PROGRAM Button (PRO)

9. FF/REW/EJECT Buttons

10. TAPE SLOT

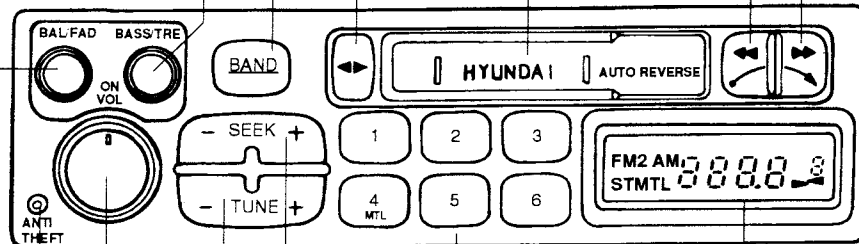

11. DIGITAL DISPLAY WINDOW

6. PRESET Buttons

5. SEEK Select Button

4. TUNE Select Button

1. POWER ON/OFF, VOLUME CONTROL Knob

12. ANTI-THEFT INDICATOR

RHA0810A

FEATURES OF YOUR HYUNDAI

DB550D1-A

1. POWER ON-OFF/VOLUME CONTROL KNOB

The radio unit may be operated when the ignition key is in the "ACC" or "ON" position. Rotate the knob clockwise to switch the radio unit on and to increase the volume. Turn the knob counterclockwise to reduce the volume and to switch the radio unit off.

2. BAL (Balance Control) Knob

Pop-up control knob with one push. Turn the control knob clockwise to emphasize right speaker sound. (Left speaker sound will be attenuated)

When the control knob is turned counterclockwise, left speaker sound will be emphasized. (Right speaker sound will be attenuated)

FAD (Fader Control) Knob

Further pull-lock position of popped-up knob. Turn the control knob clockwise to emphasize front speaker sound. (Rear speaker sound will be attenuated)

When the control knob is turned counterclockwise, rear speaker sound will be emphasized. (Front speaker sound will be attenuated)

3. BASS Control Knob

Press to pop the knob out and turn to the left or right for the desired bass tone.

TREBLE Control Knob.

Further pull-lock position of popped-up knob. Turn to the left or right for the desired treble tone.

4. TUNE (manual) Selection

Each press of the (+) side increases the frequency in 0.1 MHz steps in FM band, 9 kHz in AM band and vice versa.

With the button held down for 0.5 sec. or more, the stop signal (broadcasting radio wave) is ignored and channel selection continues.

5. SEEK Operation (Automatic Channel Selection)

When the (+) side is pressed, the unit will automatically tune to the next higher frequency and when the (-) side is pressed, it will automatically tune to the next lower frequency.

6. PRESET STATION SELECT Button

Six (6) stations for AM, FM and FM2 respectively can be preset in the electronic memory circuit on this unit.

HOW TO PRESET STATIONS

Six AM and twelve FM stations may be programmed into the memory of the radio. Then, by simply pressing the band select button and/or one of the six station select buttons, you may recall any of these stations instantly. To program the stations, follow these steps:

- o Press band selector to set the band for AM, FM, and FM2.
- o Select the desired station to be stored by seek, scan or manual tuning.
- o Determine the preset station select button you wish to use to access that station.
- o Press the station select button for more than two seconds. A select button indicator will show in the display indicating which select button you have depressed. The frequency display will flash after it has been stored into the memory.
- o You should then release the button, and proceed to program the next desired station. A total of 18 stations can be programmed by selecting one AM and one FM station per button.
- o When completed, any preset station may be recalled by selecting AM, FM or FM2 band and the appropriate station button.

FEATURES OF YOUR HYUNDAI

7. BAND Selector

Pressing the BAND button changes the AM, FM1 and FM2 bands. The mode selected is displayed on LCD.

8. TAPE PROGRAM button

This allows you to play the reverse side of the tape by merely depressing the program button. An arrow will appear in the display to show tape direction.

9. FF/REW/EJECT buttons

When you press the button whose arrow in the same direction as the tape play arrow in the display the tape will advance at high speed.

When you press the button whose arrow is in the display the tape will rewind at high speed. To stop FF or REW action, press the opposite button or press the tape program button. But if the tape program button is pressed, it will also reverse the tape play direction. To eject the tape, press the FF and REW buttons simultaneously.

FEATURES OF YOUR HYUNDAI

YB560E1-A

STEREO RADIO OPERATION (H820) (If installed)

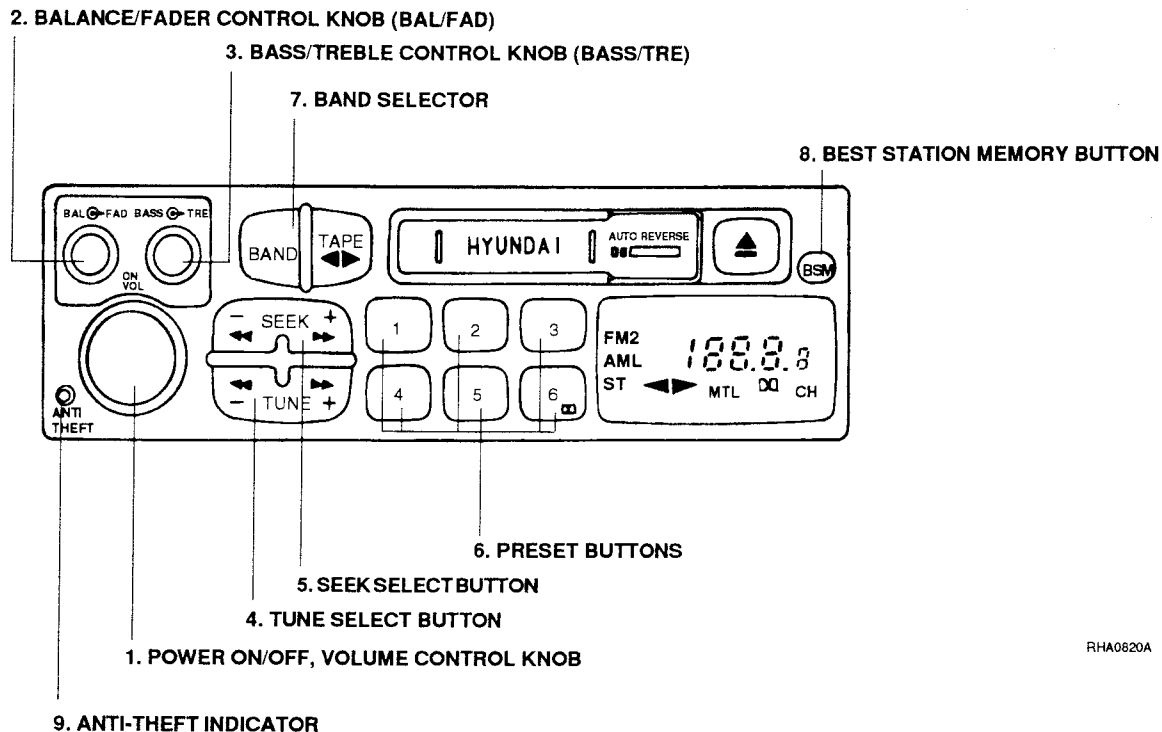

RHA0820A

FEATURES OF YOUR HYUNDAI

YB560F1-A

1. POWER ON-OFF/VOLUME CONTROL KNOB

The radio unit may be operated when the ignition key is in the "ACC" or "ON" position. Press and rotate the knob clockwise to switch the radio unit on, and to increase the volume. Turn the knob counterclockwise to reduce the volume, and press again to switch the radio unit off.

2. BAL (Balance Control) Knob

Pop-up control knob with one push. Turn the control knob clockwise to emphasize right speaker sound. (Left speaker sound will be attenuated)

When the control knob is turned counterclockwise, left speaker sound will be emphasized. (Right speaker sound will be attenuated)

FAD (Fader Control) Knob

Further pull-lock position of popped-up knob. Turn the control knob clockwise to emphasize front speaker sound. (Rear speaker sound will be attenuated)

When the control knob is turned counterclockwise, rear speaker sound will be emphasized. (Front speaker sound will be attenuated)

3. BASS Control Knob

Press to pop the knob out and turn to the left or right for the desired bass tone.

TREBLE Control Knob

Further pull-lock position of popped-up knob. Turn to the left or right for the desired treble tone.

4. TUNE (Manual) Selection

Each press of the (+) side increases the frequency in 0.2 MHz steps in FM band, 10 KHZ in AM band and vice versa.

With the button held down for 0.5 sec. or more, the stop signal (broad casting radio wave) is ignored and channel selection continues.

5. SEEK Operation

(Automatic Channel Selection)

When the (+) side is pressed, the unit will automatically tunes to the next higher frequency and when the (-) side is pressed, it will automatically tunes the next lower frequency.

6. PRESET STATION SELECT Button

Six (6) station for AM, FM and FM2 respectively can be preset in the electronic memory circuit on this unit.

HOW TO PRESET STATIONS

Six AM and twelve FM stations may be programmed into the memory of the radio. Then, by simply pressing the band select button and/or one of the six station select buttons, you may recall any of these stations instantly. To program the stations, follow these steps:

- o Press band selector to set the band for AM, FM and FM2.
- o Select the desired station to be stored by seek, scan or manual tuning.
- o Determine the preset station select button you wish to use to access that station.
- o Press the station select button for more than two seconds. A select button indicator will show in the display indicating which select button you have depressed. The frequency display will flash after it has been stored into the memory.
- o You should then release the button, and proceed to program the next desired station. A total of 18 stations can be programmed by selecting one AM and two FM stations per button.
- o When completed, any preset station may be recalled by selecting AM, FM or FM2 band and the appropriate station button.

FEATURES OF YOUR HYUNDAI

7. BAND Selector

Pressing the BAND button changes the AM, FM1 and FM2 bands. The mode selected is displayed on LCD.

8. BEST STATION MEMORY Button (BSM)

When the BSM button is pressed for two seconds or longer, the preceding memory is all cleared, and six channels with the highest field intensity are selected and kept in memory of the preset key in the sequence of the preset key in the sequence of frequencies.

FEATURES OF YOUR HYUNDAI

YB560G1-A

CASSETTE TAPE PLAYER OPERATION (H820)

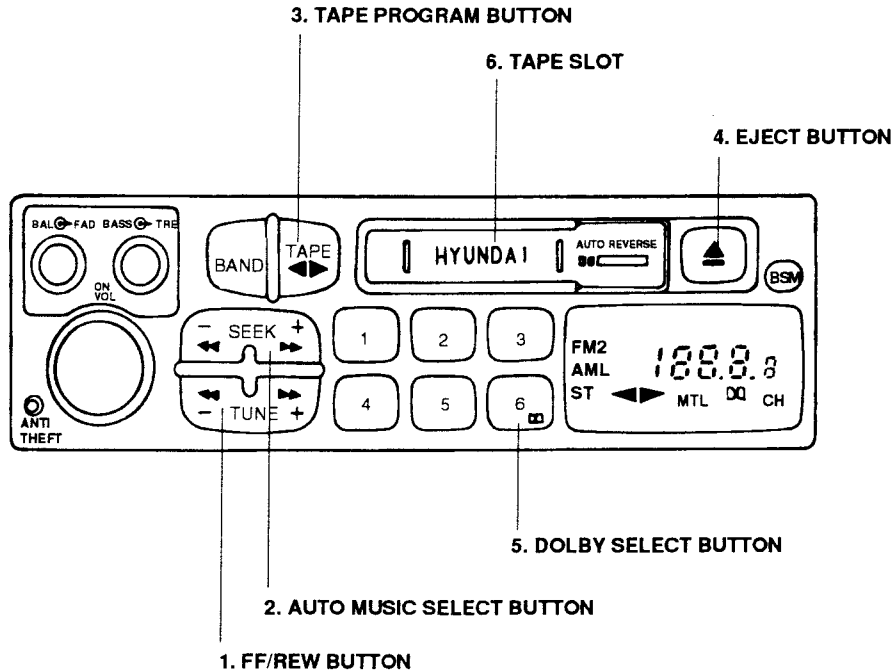

RHA0820C

FEATURES OF YOUR HYUNDAI

YB560H1-A

1. FF/REW BUTTON

- o The FF (fast forward tape winding) starts when the (+) side is pressed during the PLAY or REW.
- o The play starts when the (+) side is pressed again during the FF.
- o The REW (rewinding) starts when the (-) side is pressed during the PLAY or FF.
- o The play starts when the (-) side is pressed again during the REW.

2. AUTO MUSIC SELECT BUTTON

Press the button to find the starting point of each song in a prerecorded music tape.

The quiet space between songs (must have at least a 4 sec. gap) can be accepted by the AUTO MUSIC SELECT button.

- o Pressing the (+) side will play the beginning of the next music segment.
- o Pressing the (-) side will start replay at the beginning of the music just listened to.

3. TAPE PROGRAM BUTTON

This allows you to play the reverse side of the tape by merely depressing the program button. An arrow will appear in the display to show tape direction.

4. EJECT BUTTON

- o When the EJECT button is pressed with the cassette loaded, the cassette is ejected.
- o When the EJECT button is pressed during the FF/REW, the cassette is ejected.

5. DOLBY SELECT BUTTON

If you get background noise during PLAY, you can reduce this considerably by merely pressing DOLBY SELECT button.

If you want to release, press the button again.

FEATURES OF YOUR HYUNDAI

AB540C1-A

Care of Cassette Tapes

Proper care of your cassette tapes will extend the tape life and increase your listening enjoyment. Always protect your tapes and cassette cases from direct sunlight, severe cold and dusty conditions. When not in use, cassettes should always be stored in the protective cassette case in which they were originally supplied. When the vehicle is very hot or cold, allow the interior temperature to become more comfortable before listening to your cassettes.

- o Never leave a cassette inserted in the player when not being played. This could damage the tape player unit and the cassette tape.
- o We strongly recommend against the use of tapes longer than C-60 (60 minutes total). Tapes such as C-120 or C-180 are very thin and do not perform as well in the automotive environment.

- o Be sure that the cassette label is not loose or peeling off or tape ejection may be difficult.
- o Never touch or soil the actual audio tape surfaces.
- o Keep all magnetized objects, such as electric motors, speakers or transformers away from your cassette tapes and tape player unit.
- o Store cassettes in a cool, dry place with the open side facing down to prevent dust from settling in the cassette body.
- o Avoid repeated fast reverse usage to replay one given tune or tape section. This can cause poor tape winding to occur, and eventually cause excessive internal drag and poor audio quality in the cassette. If this occurs, it can sometimes be corrected by fast winding the tape from end to end several times. If this does not correct the problem, do not continue to use the tape in your vehicle.

- o The playback head, capstan and pinch rollers will develop a coating of tape residue that can result in deterioration of sound quality, such as a wavering sound. They should be cleaned monthly using a commercially available head cleaning tape or special solution available from audio specialty shops. Follow the supplier's directions carefully and never oil any part of the tape player unit.
- o Always be sure that the tape is tightly wound on its reel before inserting in the player. Rotate a pencil in the drive sprockets to wind up any slack.

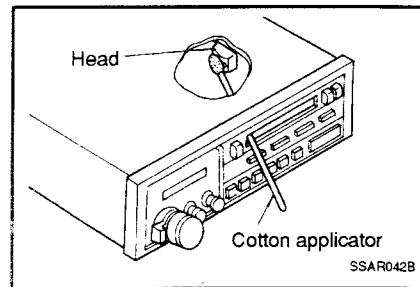
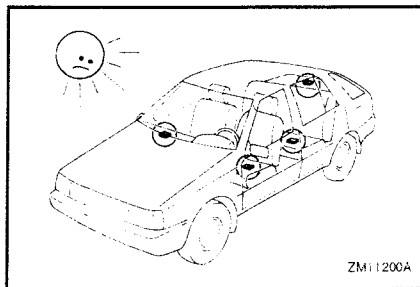
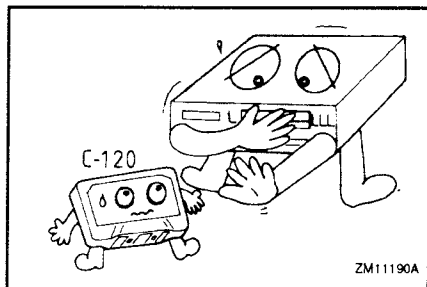

FEATURES OF YOUR HYUNDAI

NOTE:

Look at a tape before you insert it.

If the tape is loose, tighten it by turning one of the hubs with a pencil or your finger. If the label is peeling off, do not put it in the player. It may cause the tape to jam in the drive mechanism when you try to eject it.

Do not leave tapes sitting where they are exposed to high temperatures or, high humidity, such as on top of the dashboard or in the player.

If a tape is exposed to extreme heat or cold, let it reach a moderate temperature before putting it in the player.

ZC010A1-A

2. BEHIND THE WHEEL

Driving Your Hyundai

DRIVING YOUR HYUNDAI

ZC020A1-A

WARNING

WARNING: ENGINE EXHAUST CAN BE DANGEROUS!

Engine exhaust fumes can be extremely dangerous. If, at any time, you smell exhaust fumes inside the vehicle, open the windows immediately.

o Do not inhale exhaust fumes.

Exhaust fumes contain carbon monoxide, a colorless, odorless gas that can cause unconsciousness and death by asphyxiation.

o Be sure the exhaust system does not leak.

The exhaust system should be checked whenever the vehicle is raised to change the oil or for any other purpose. If you hear a change in the sound of the exhaust or if you drive over something that strikes the underneath side of the car, have the exhaust system checked as soon as possible by your Hyundai dealer.

o Do not run the engine in an enclosed area.

Letting the engine idle in your garage, even with the garage door open, is a hazardous practice. Never run the engine in your garage any longer than it takes to start the engine and back the car out.

o Avoid idling the engine for prolonged periods with people inside the car.

If it is necessary to idle the engine for a prolonged period with people inside the car, be sure to do so only in an open area with the air intake set at "Fresh" and fan operating at one of the higher speeds so fresh air is drawn into the interior.

If you must drive with the hatchback/trunk open because you are carrying objects that make this necessary:

1. Close all windows.
2. Open side vents.
3. Set the air intake control at "Fresh", the air flow control at "Floor" or "Face" and the fan at one of the higher speeds.

To assure proper operation of the ventilation system, be sure the ventilation air intakes located just in front of the windshield are kept clear of snow, ice, leaves or other obstructions.

DRIVING YOUR HYUNDAI

ZC030A1-A

BEFORE STARTING THE ENGINE

Before you start the engine, you should always:

1. Look around the vehicle to be sure there are no flat tires, puddles of oil or water or other indications of possible trouble.
2. After entering the car, check to be sure the parking brake is engaged.
3. Check your seat, seatback and headrest to be sure they are in their proper positions.
4. Check the position of the interior and exterior mirrors.
5. Lock all the doors.
6. Fasten your seat belt and be sure that all other occupants have fastened theirs.
7. Turn off all lights and accessories that are not needed.
8. When you turn the ignition switch to "ON" check that all appropriate warning lights are operating and that you have sufficient fuel.

ZC040A3-A

COMBINATION IGNITION SWITCH AND STEERING LOCK

To Start the Engine

Before starting the engine:

- o If your Hyundai is equipped with a manual transaxle, place the shift lever in neutral and depress the clutch.

NOTE:

For safety, the engine will not start if the clutch pedal is not depressed fully.

- o If your Hyundai has an automatic transaxle, place the shift lever in "P" (park).

NOTE:

The ignition key cannot be turned from "ACC" position to "LOCK" position unless the shift lever is in the "P" (Park) position or the negative battery terminal is disconnected from the battery. To remove the key, always confirm that the shift lever is securely positioned in "P" (Park) and then release the release button on the shift lever. (For Auto T/A)

To start the engine, insert the ignition key and turn it to the "START" position. Release it as soon as the engine starts. Do not hold the key in the "START" position for more than 15 seconds.

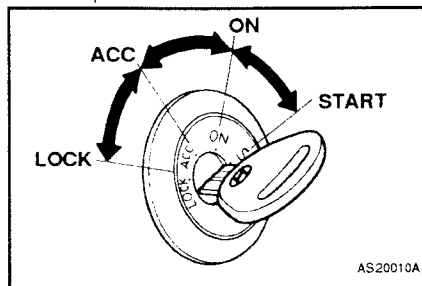

AC050A1-A

KEY POSITIONS

WARNING

The engine should not be turned off or the key removed from the ignition key cylinder while the car is in motion. The steering wheel is locked by removing the key.

"ON"

When the key is in the "ON" position, the ignition is on and all accessories may be turned on. If the engine is not running, the key should not be left in the "ON" position. This will discharge the battery and may also damage the ignition system.

NOTE:

For additional information about starting, see page 2-4.

"ACC"

With the key in the "ACC" position, the radio and other accessories may be operated. If you open the driver's door with the key in the "ACC" or "LOCK" position, the chime will sound to remind you that the key should be removed.

"LOCK"

The key can be removed or inserted in this position. The steering wheel is locked by removing the key. When unlocking the steering wheel, insert the key, and then turn the steering wheel and key simultaneously.

DRIVING YOUR HYUNDAI

ZC060A1-A

STARTING (Multiport Fuel Injection)

Normal starting with either a cold or warm engine is obtained without pumping or depressing the accelerator pedal. Simply turn the key to the "Start" position and release when the engine starts.

After the engine has started, allow the engine to run for 10 to 20 seconds prior to placing the vehicle in gear.

The starter should not be operated for more than 15 seconds at a time. Wait 15-30 seconds between starting attempts to protect the starter from overheating.

WARNING

Never run the engine in a closed or poorly ventilated area any longer than is needed to move your car in or out of the area. The carbon monoxide gas emitted is odorless and can cause serious injury or death.

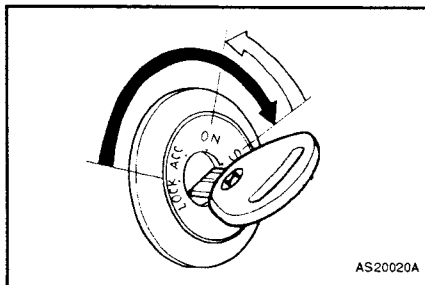

2- 4

ZC070A1-A

NORMAL CONDITIONS

The Starting Procedure:

1. Insert key, and fasten the seat belt.
2. Depress the clutch pedal fully and place the gearshift lever (manual transaxle) in neutral or the selector lever (automatic transaxle) in "P" (park) position.
3. After turning the ignition key to the "ON" position, make certain all warning lights and gauges are functioning properly before starting the engine.
4. Turn the ignition key to the "Start" position and release it when the engine starts.

ZC090A2-A

OPERATING THE MANUAL TRANSAXLE

Your Hyundai's manual transaxle has a conventional shift pattern. This shift pattern is also imprinted on the shift knob. The transaxle is fully synchronized in all forward gears so shifting to either a higher or a lower gear is easily accomplished.

NOTE:

To shift into reverse, rest the lever in neutral for at least 3 seconds after your car is completely stopped. Then move the lever into the reverse position.

CAUTION:

When downshifting from fifth gear to fourth gear, caution should be taken not to inadvertently press the gear shift lever sideways in such a manner that second gear is engaged.

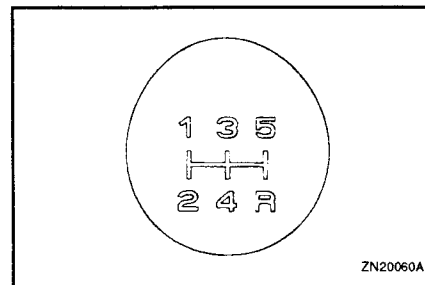

ZN20060A

DRIVING YOUR HYUNDAI

Such a drastic downshift may cause the engine speed to increase to the point that the tachometer will enter the red-zone (if equipped). Such over revving of the engine may possibly cause engine damage.

ZC090B1-A

Using the Clutch

The clutch should be pressed all the way to the floor before shifting, then released slowly. Do not rest your foot on the clutch pedal while driving. This can cause unnecessary wear. Do not partially engage the clutch to hold the car on an incline. This causes unnecessary wear. Use the parking brake to hold the car on an incline. Do not operate the clutch pedal rapidly and repeatedly.

ZC090D2-A

To Remove the Ignition Key

1. Turn the ignition key to the "ACC" position.

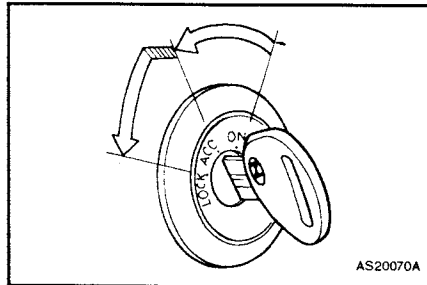

2. Simultaneously push and turn the ignition key counterclockwise from the "ACC" position to the "LOCK" position.
3. The key can be removed in the "LOCK" position.

ZC090C1-A

Good Driving Practices

- o Never take the car out of gear and coast down a hill. This is extremely hazardous. Always leave the car in gear.
- o Don't "ride" the brakes. This can cause them to overheat and malfunction. Instead, when you are driving down a long hill, slow down and shift to a lower gear. When you do this, engine braking will help slow the car.
- o Slow down before shifting to a lower gear. This will help avoid over-revving the engine, which can cause damage.
- o Slow down when you encounter cross winds. This gives you much better control of your car.
- o Be sure the car is completely stopped before you attempt to shift into reverse. The transaxle can be damaged if you do not. To shift into reverse, depress the clutch, move the shift lever to neutral, wait three seconds, then shift to the reverse position.
- o Exercise extreme caution when driving on a slippery surface. Be especially careful when braking, accelerating or shifting gears. On a slippery surface, an abrupt change in vehicle speed can cause the drive wheels to lose traction and the vehicle to go out of control.

ZC100A2-A

RECOMMENDED SHIFT SPEEDS

The shift speeds as shown below are recommended for optimum fuel economy and performance.

| Shift from-to | Recommended mph (km/h) |
|---------------|------------------------|
| 1-2 or 2-1 | 15 (20) |
| 2-3 or 3-2 | 25 (40) |
| 3-4 or 4-3 | 35 (55) |
| 4-5 or 5-4 | 45 (75) |

DRIVING YOUR HYUNDAI

JC110A1-A

AUTOMATIC TRANSAXLE

The highly efficient Hyundai automatic transaxle has four forward speeds and one reverse speed. It has a conventional shift pattern as shown below. At night, with the side markers or headlights switched on, the appropriate symbol on the quadrant will be illuminated according to the range selected.

CAUTION:

Never shift into "R" or "P" position while the car is moving.

➡ Depress the brake pedal and push the button when shifting

➡ Push the button when shifting

➡ The selector lever can be shifted freely.

For optimum fuel economy, accelerate gradually. The transaxle will automatically shift to the second, third and overdrive gears.

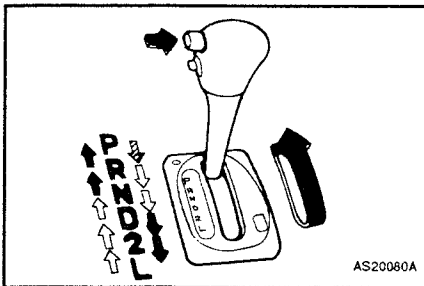

ZC110B1-A

The function of each position is as follows:

o P (Park):

Use to hold the vehicle in place when parking or while starting the engine; shift the selector lever to the "P" position. Whenever parking the car, apply the parking brake and shift the selector lever to the "P" position.

CAUTION:

Never place the selector lever in the "P" position unless the vehicle is fully stopped. Failure to observe this caution will cause severe damage to the transaxle.

ZC110C1-A

o R (Reverse):

Use for backing up the vehicle. Bring the car to a complete stop before shifting the selector lever to "R" position.

ZC110D1-A

o N (Neutral):

In the "N" position, the transaxle is in neutral, which means that no gears are engaged. The engine can be started with the shift lever in "N" position, although this is not recommended except if the engine stalls while the car is moving.

ZC110E1-A

o D (Drive):

Use for normal driving. The transaxle will automatically shift through a four-gear sequence, giving best economy and power. Never downshift manually to "2" position or "L" position when vehicle speed is more than 60 mph (95 km/h).

ZC110F1-A

o 2 (Second gear):

Use for driving on a slippery road, hill climbing or engine braking downhill. "2" automatically shifts between 1st and 2nd gears.

This means that no shift-up to 3rd gear is performed. However, the shift-up to 3rd gear is done when the car speed exceeds a certain value to prevent the engine from over-revving.

Manually move the selector to "D" when returning to normal driving condition.

ZC110G1-A

o L (Low gear):

Use for driving up a very steep grade or for engine braking when descending steep hills. When downshifting to "L", the transaxle will temporarily remain in second gear until the vehicle has slowed enough for low gear to engage. Do not exceed 31 mph (50 km/h) in low gear.

"L" engages 1st gear only. However, shift-up to 2nd is performed when the car exceeds a certain speed, and as the speed increases, shift up to 3rd gear occurs to prevent over-revving the engine.

DRIVING YOUR HYUNDAI

ZC110H1-A

NOTE:

- For smooth operation, depress the brake pedal when shifting from NEUTRAL or PARK to a forward or reverse gear.
- The ignition key must be in the "ON" position and the brake pedal fully depressed in order to move the shift lever from the "P" (Park) position to any of the other positions.
- It is always possible to shift from "R", "N", "D", "2", "L" position to "P" position.

ZC110I1-A

CAUTION:

- Shift into "R" and "P" only when the vehicle has completely stopped.
- Do not accelerate the engine in the reverse or any of the forward positions with the brakes applied.
- Always apply the footbrake when shifting from "P" or "N", to "R", "D", "2" or "L".
- Do not use the P (Park) position in place of the parking brake. Always set the parking brake, shift the transaxle into "P" (Park) and turn off the ignition when you leave the vehicle, even momentarily. Never leave the vehicle unattended while the engine is running.
- Check the automatic transaxle fluid level regularly, and add fluid as necessary.

JC110J4-A

SHIFT LOCK RELEASE (If installed)

If you cannot move the shift lever from the "P" (Park) position to any other position with the brake pedal fully depressed and the ignition key in the "ON" position, remove the cap on the console and with a thin object such as a pencil, push the shift lock release button down. Then, with the brake pedal depressed, move the shift lever to the desired position, then the shift lock release button will automatically return to its original position after shifting from the "P" (Park) position. Then, reinstall the cap.

Have the system checked by your Hyundai dealer.

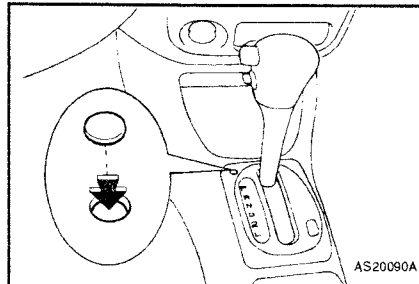

ZC120A1-A

Driving with Electronic Dual-range Automatic Transaxle

The electronically controlled dual-range (Normal/Economy) 4 speed automatic transaxle is available for your Hyundai. The automatic transaxle features the latest electronics to realize precise and reliable transaxle control by fingertip "Normal/Economy" switchover.

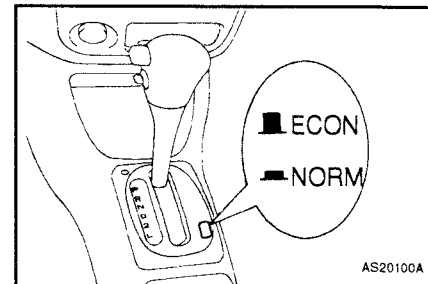

DRIVING YOUR HYUNDAI

AC120B1-A

To Drive with "Economy" Mode

The "Economy" mode offers quiet and smooth auto-shifting with outstanding fuel economy. The "Economy" mode is recommended for normal driving. Set the driving pattern selector switch to the "ECON" position.

Shift the selector lever to the "D" range and depress the accelerator pedal slowly. If you need rapid acceleration, fully depress the accelerator pedal.

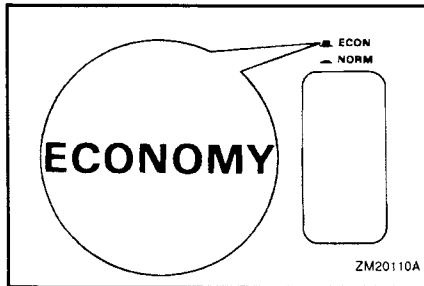

AC120C1-A

To Drive in "Normal" Mode

In the "Normal" mode you can obtain full potential of the engine for maximum acceleration and driveability. The "Normal" mode is recommended for higher speeds than the "Economy" mode, driving in mountainous areas and for strong acceleration. Set the driving pattern selector switch to the "NORM" position.

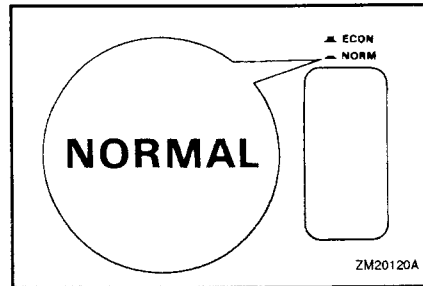

ZC120D1-A

Good Driving Practices

- o Never move the gear selector lever from "P" or "N" to any other position with the accelerator pedal depressed.
- o Never move the gear selector lever into "P" when the vehicle is in motion.
- o Be sure the car is completely stopped before you attempt to shift into "R".
- o Never take the car out of gear and coast down a hill. This may be extremely hazardous. Always leave the car in gear when moving.
- o Do not "ride" the brakes. This can cause them to overheat and malfunction. Instead, when you are driving down a long hill, slow down and shift to a lower gear. When you do this, engine braking will help slow the car.
- o Slow down before shifting to a lower gear. Otherwise, the lower gear may not be engaged.
- o Always use the parking brake. Do not depend on placing the transaxle in "P" to keep the car from moving.
- o Exercise extreme caution when driving on a slippery surface. Be especially careful when braking, accelerating or shifting gears. On a slippery surface, an abrupt change in vehicle speed can cause the drive wheels to lose traction and the vehicle to go out of control.

DRIVING YOUR HYUNDAI

- o Turn the overdrive switch on for good fuel economy and smooth driving. If engine braking is needed in the "D" range or if repeated upshifting and downshifting between the 3rd and 4th gear is needed when climbing a gentle slope, it is recommended that the overdrive switch be turned off. Turn the overdrive switch back on immediately afterward.

ZC130A1-B

OVERDRIVE SWITCH

When the overdrive switch is turned on, the transaxle will automatically upshift to the second, third and overdrive gears. When the overdrive switch is turned off, the transaxle will not upshift to the overdrive gear. For normal driving, the selector lever should be left in the "D" position and the overdrive switch turned on.

If you need to accelerate rapidly, press the accelerator pedal all the way to the floor. The transaxle will automatically shift to a lower gear, depending on the vehicle speed and load.

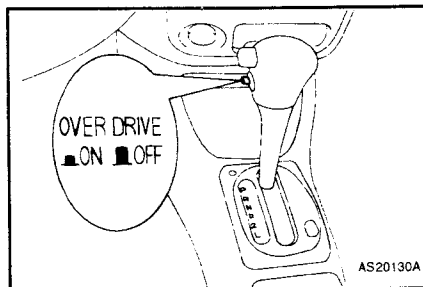

ZC140A1-A

GOOD BRAKING PRACTICES

WARNING

Nothing should be carried on top of the cargo area cover behind the rear seat. If there were an accident or a sudden stop, such objects could move forward and cause damage to the vehicle or injure the occupants.

- o After being parked, check to be sure the parking brake is not engaged and that the parking brake indicator light is out before driving away.
- o Driving through water may get the brakes wet. They can also get wet when the car is washed. Your car may not stop as quickly if the brakes are wet and it may also pull to one side. To dry the brakes, apply the brakes lightly until the braking action returns to normal, taking care to keep the car under control at all times. If the braking action does not return to normal, stop as soon as it is safe to do so and call your Hyundai dealer for assistance.
- o Don't coast down hills with the car out of gear. This may be extremely hazardous. Keep the car in gear at all times, use the brakes to slow down, then shift to a lower gear so that engine braking will help you maintain a safe speed.

DRIVING YOUR HYUNDAI

- Don't "ride" the brake pedal. Resting your foot on the brake pedal while driving can be dangerous because it can result in the brakes overheating and losing their effectiveness. It also increases the wear of the brake components.
- If a tire goes flat while you are driving, apply the brakes gently and keep the car pointed straight ahead while you slow down. When you are moving slowly enough for it to be safe to do so, pull off the road and stop in a safe place.
- If your car is equipped with an automatic transaxle, don't let your car creep forward. To avoid creeping forward, keep your foot on the brake pedal when the car is stopped.
- Use caution when parking on a hill. Engage the parking brake and place the gear selector lever in "P" (automatic transaxle) or in first or reverse gear (manual transaxle). If your car is facing downhill, turn the front wheels into the curb to help keep the car from rolling. If your car is facing uphill, turn the front wheels away from the curb to help keep the car from rolling. If there is no curb or if it is required by other conditions to keep the car from rolling, block the wheels.
- Under some conditions your parking brake can freeze in the engaged position. This is most likely to happen when there is an accumulation of snow or ice around or near the rear brakes or if the brakes are wet. If there is a risk that the parking brake may

freeze, apply it only temporarily while you put the gear selector lever in "P" (automatic) or in first or reverse gear (manual transaxle) and block the rear wheels so the car cannot roll. Then release the parking brake.

YC250A1-A

ANTI-LOCK BRAKE SYSTEM (If equipped)

The Anti-Lock Brake System (ABS) is designed to prevent wheel lock-up during sudden braking or on hazardous road surfaces. The ABS control module monitors the wheel speed and controls the pressure applied to each brake. Thus, in emergency situations or on slick roads, your ABS will increase vehicle control during braking.

NOTE:

During ABS operation, a slight pulsation may be felt in the brake pedal when the brakes are applied. Also, a noise may be heard in the engine compartment while driving. These conditions are normal and indicate that the anti-lock brake system is functioning properly.

WARNING

Your ABS will not prevent accidents due to improper or dangerous driving maneuvers. Even though vehicle control is improved during emergency braking, always maintain a safe distance between you and objects ahead. Vehicle speeds should always be reduced during extreme road conditions. The safety features of an ABS equipped vehicle

should not be tested by high speed driving or cornering. This could endanger the safety of yourself or others.

ZC150A1-A

DRIVING FOR ECONOMY

You can save fuel and get more miles from your car if you follow these suggestions:

- Drive smoothly. Accelerate at a moderate rate. Don't make "jack-rabbit" starts or full-throttle shifts and maintain a steady cruising speed. Don't race between stoplights. Try to adjust your speed to that of the other traffic so you don't have to change speeds unnecessarily. Avoid heavy traffic whenever possible. Always maintain a safe distance from other vehicles so you can avoid unnecessary braking. This also reduces brake wear.
- Drive at a moderate speed. The faster you drive, the more fuel your car uses. Driving at a moderate speed, especially on the highway, is one of the most effective ways to reduce fuel consumption.
- Don't "ride" the brake or clutch pedal. This can increase fuel consumption and also increase wear on these components. In addition, driving with your foot resting on the brake pedal may cause the brakes to overheat, which reduces their effectiveness.
- Take care of your tires. Keep them inflated to the recommended pressure. Incorrect inflation, either too much or too little, results in unnecessary tire wear. Check the tire pressures at least once a month.

DRIVING YOUR HYUNDAI

- o Be sure that the wheels are aligned correctly. Improper alignment can result from hitting curbs or driving too fast over irregular surfaces. Poor alignment causes faster tire wear and may also result in other problems as well as greater fuel consumption.
- o Keep your car in good condition. For better fuel economy and reduced maintenance costs, maintain your car in accordance with the maintenance schedule in Section 5. If you drive your car in severe conditions, more frequent maintenance is required (see Section 5 for details).
- o Keep your car clean. For maximum service, your Hyundai should be kept clean and free of corrosive materials. It is especially important that mud, dirt, ice, etc. not be allowed to accumulate on the underside of the car. This extra weight can result in increased fuel consumption and also contribute to corrosion.
- o Travel lightly. Don't carry unnecessary weight in your car. Weight is an enemy of good fuel economy.
- o Don't let the engine idle longer than necessary. If you are waiting (and not in traffic), turn off your engine and restart only when you're ready to go.
- o Remember, your Hyundai does not require extended warm-up. As soon as the engine is running smoothly, you can drive away. In very cold weather, however, give your engine a slightly longer warm-up period.
- o Don't "lug" or "over-rev" the engine. Lugging is driving too slowly in too high a gear resulting in the engine bucking. If this happens, shift to

a lower gear. Over-revving is racing the engine beyond its safe limit. This can be avoided by shifting at the recommended speeds.

- o Use your air conditioning sparingly. The air conditioning system is operated by engine power so your fuel economy is reduced when you use it.

ZC160A1-A

SMOOTH CORNERING

Avoid braking or gear changing in corners, especially when roads are wet. Ideally, corners should always be taken under gentle acceleration. If you follow these suggestions, tire wear will be held to a minimum.

ZC170A1-A

WINTER DRIVING

The more severe weather conditions of winter result in greater wear and other problems. To minimize the problems of winter driving, you should follow these suggestions:

ZC170B1-A

Snow or Icy Conditions

To drive your vehicle in deep snow, it may be necessary to use snow tires or to install tire chains on your tires. If snow tires are needed, it is necessary to select tires equivalent in size and type to the original equipment tires. Failure to do so may adversely affect the safety and handling of your car. Speeding, rapid acceleration, sudden brake applications, and sharp turns are potentially very hazardous practices.

During deceleration, use engine braking to the fullest extent. Sudden brake applications on snowy or icy roads may cause skids to occur. You need to keep sufficient distance between the vehicle in front of your vehicle. Also, apply the brake gently. It should be noted that installing tire chains on the tire will provide a greater driving force, but will not prevent side skids.

NOTE:

Tire chains are not legal in all states. Check state laws before fitting tire chains.

ZC170C1-A

Use High Quality Ethylene Glycol Coolant

Your Hyundai is delivered with high quality ethylene glycol coolant in the cooling system. It is the only type of coolant that should be used because it helps prevent corrosion in the cooling system, lubricates the water pump and prevents freezing. Be sure to replace or replenish your coolant in accordance with the maintenance schedule in Section 5. Before winter, have your coolant tested to assure that its freezing point is sufficient for the temperatures anticipated during the winter.

ZC170D1-A

Check Battery and Cables

Winter puts additional burdens on the battery system. Visually inspect the battery and cables as described in Section 6. The level of charge in your battery can be checked by your Hyundai dealer or a service station.

DRIVING YOUR HYUNDAI

ZC170E1-A

Change to "Winter Weight" Oil if Necessary

In some climates it is recommended that a lower viscosity "winter weight" oil be used during cold weather. See Section 9 for recommendations. If you aren't sure what weight oil you should use, consult your Hyundai dealer.

ZC170F1-A

Check Spark Plugs and Ignition System

Inspect the spark plugs as described in Section 6 and replace them if necessary. Also check all ignition wiring and components to be sure they are not cracked, worn or damaged in any way.

ZC170G1-A

To Keep Locks from Freezing

To keep the locks from freezing, squirt an approved de-icer fluid or glycerine into the key opening. If a lock is covered with ice, squirt it with an approved de-icing fluid to remove the ice. If the lock is frozen internally, you may be able to thaw it out by using a heated key. Handle the heated key with care to avoid burning your fingers.

ZC170H1-A

Use Approved Anti-Freeze in Window Washer System

To keep the water in the window washer system from freezing, add an approved anti-freeze solution in accordance with instructions on the container. Window washer anti-freeze is available

from Hyundai dealers and most auto parts outlets. Do not use engine coolant or other types of anti-freeze as these may damage the finish.

ZC170I1-A

Don't Let Your Parking Brake Freeze

Under some conditions your parking brake can freeze in the engaged position. This is most likely to happen when there is an accumulation of snow or ice around or near the rear brakes or if the brakes are wet. If there is a risk that the parking brake may freeze, apply it only temporarily while you put the gear selector lever in "P" (automatic) or in first or reverse gear (manual transaxle) and block the rear wheels so the car cannot roll. Then release the parking brake.

ZC170J1-A

Don't Let Ice and Snow Accumulate Underneath

Under some conditions, snow and ice can build up under the fenders and interfere with the steering. When driving in severe winter conditions where this may happen, you should periodically check underneath the car to be sure the movement of the front wheels and the steering components are not obstructed.

ZC170K1-A

Carry Emergency Equipment

Depending on the severity of the weather where you drive your car, you should carry appropriate emergency equipment. Some of the items you may want to carry include tire chains, tow straps or chains, flashlight, emergency flares, sand, a

shovel, jumper cables, a window scraper, gloves, ground cloth, coveralls, a blanket, etc.

ZC180A1-A

HIGH SPEED MOTORING

Pre-Trip Inspections

1. Tires;

Adjust the tire inflation pressures for highway driving. Low tire inflation pressures will result in overheating and possible failure of the tires. Avoid using worn or damaged tires which may result in reduced traction or tire failure.

NOTE:

Never exceed the maximum tire inflation pressure shown on the tires.

2. Fuel, engine coolant and engine oil;

High speed travel consumes 1.5 times more fuel than urban motoring. Do not forget to check both engine coolant and engine oil.

3. Drive belt;

A loose or damaged drive belt may result in overheating of the engine.

ZC190A1-A

USE OF LIGHTS

Check your lights regularly for correct operation and always keep them clean. When driving during the day in conditions of poor visibility, it is helpful to drive with headlights on low beam. This enables you to be seen as well as to see.

AC210A1-A

TRAILER TOWING

Your Hyundai should not be used to tow a trailer. It is designed to be compact and light for good fuel economy, and is not designed as a trailer-towing vehicle.

Damages or malfunctions caused by towing may not be covered by the limited warranties applying to your Hyundai. Damages or malfunctions that result from towing a trailer for commercial purposes are specifically not covered by Hyundai limited warranties.

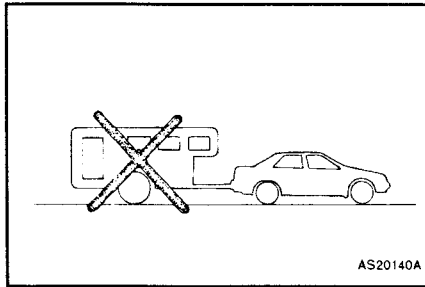

ZD010A1-A

3. TROUBLE ON THE ROAD

What to do in an Emergency

WHAT TO DO IN AN EMERGENCY

ZD020A1-A

IF THE ENGINE WILL NOT START CAUTION:

If the engine will not start, do not push or pull the car to start it. This could result in a collision or cause other damage. In addition, push or pull starting may cause the catalytic converter to be overloaded and create a fire hazard.

ZD020B1-A

If Engine Doesn't Turn Over or Turns Over Slowly

1. If your car has an automatic transaxle be sure the gear selector lever is in "N" or "P" and the emergency brake is set.
2. Check the battery connections to be sure they are clean and tight.
3. Turn on the interior light. If the light dims or goes out when you operate the starter, the battery is discharged.

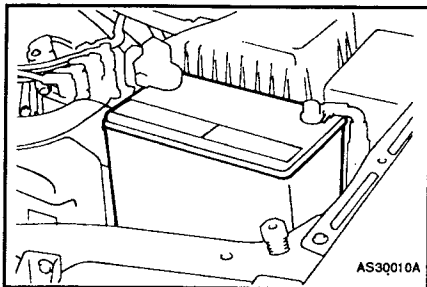

4. Do not push or pull the vehicle to start it. See instructions for "Jump Starting" on the following pages.

AD020C1-A

If Engine Turns Over Normally but Does Not Start

1. Check fuel level.
2. Check all connectors at coil and spark plugs. Re-connect any that may be disconnected or loose.
3. If engine still refuses to start, call a Hyundai dealer or seek other qualified assistance.

AD020D1-A

If Engine Stalls While Driving

1. Reduce your speed gradually, keeping a straight line. Move cautiously off the road to a safe place.
2. Turn on your emergency flashers.
3. Try starting the engine again. If your vehicle

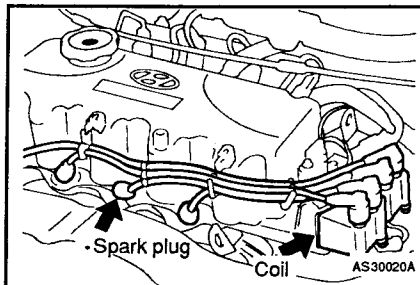

will not start, see "IF THE ENGINE WILL NOT START".

ZD030A1-A

JUMP STARTING WARNING

The gas produced by the battery during the jump-start operation is highly explosive. If these instructions are not followed exactly, serious personal injury and damage to the vehicle may occur! If you are not sure how to follow this procedure, seek qualified assistance. Automobile batteries contain sulfuric acid. This is poisonous and highly corrosive. When jump starting, wear protective glasses and be careful not to get acid on yourself, your clothing or on the car.

- o If you should accidentally get acid on your skin or in your eyes, immediately remove any contaminated clothing and flush the area with clear water for at least 15 minutes. Then

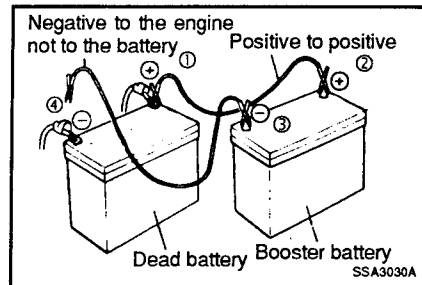

WHAT TO DO IN AN EMERGENCY

promptly obtain medical attention. If you must be transported to an emergency facility, continue to apply water to the affected area with a sponge or cloth.

- o The gas produced by the battery during the jump-start operation is highly explosive. Do not smoke or allow a spark or open flame in the vicinity.
- o The battery being used to provide the jump start must be 12-volt. If you cannot determine that it is a 12-volt battery, do not attempt to use it for the jump start.
- o To jump start a car with a discharged battery, follow this procedure exactly:
 1. If the booster battery is installed in another vehicle, be sure the two vehicles are not touching.
 2. Turn off all unnecessary lights and accessories in both vehicles.
 3. Attach the clamps of the jumper cable in the exact order shown on the previous page. That is, first, attach one clamp of the jumper cable to the positive (+) post or cable of the discharged battery. Then attach the other end of the same cable to the positive (+) post or cable of the booster battery. Next, using the other cable, attach one clamp to the negative (-) post or cable of the booster battery. Then attach the other end of that cable to a solid metal part of the engine away from the battery. Do not connect the cable to any moving part.

4. Start the engine in the car with the booster battery and let it run for a few minutes. This will help to assure that the booster battery is fully charged. During the jumping operation, run the engine in this vehicle at about 2000 rpm.
5. Start your engine using the normal starting procedure. After the engine starts, leave the jumper cables connected and let the engine run at fast idle or about 2000 rpm for several minutes.
6. Following the exact reverse order of their being attached, carefully remove the jumper cables. Remove the negative cable first, then the positive cable.

If you do not know why your battery became discharged (because the lights were left on, etc.), have the charging system checked by your Hyundai dealer.

AD040A1-A

IF THE ENGINE OVERHEATS

If your temperature gauge indicates overheating, you experience a loss of power, or hear loud ping or knocking, the engine is probably too hot. If this happens, you should:

1. Pull off the road and stop as soon as it is safe to do so.
2. Place the gear selector lever in "P" (automatic), or neutral (manual transaxle) and set the parking brake. If the air conditioning is on, turn it off.
3. If engine coolant is running out under the car or steam is coming out from the hood, stop the engine. Do not open the hood until the engine coolant has stopped running or the steaming has stopped. If there is no visible loss of engine coolant and no steam, leave the engine running and check to be sure the engine coolant fan is operating. If the fan is not running, turn the engine off.
4. Check to see if the water pump drive belt is missing. If it is not missing, check to see that it is tight. If the drive belt seems to be satisfactory, check for engine coolant leaking from the radiator, hoses or under the car. (If the air conditioning had been in use, it is normal for cold water to be draining from it when you stop).

WHAT TO DO IN AN EMERGENCY

WARNING

While the engine is running, keep hands, long hair and clothing away from moving parts such as the fan and drive belts to prevent injury.

5. If the water pump drive belt is broken or engine coolant is leaking out, stop the engine immediately and call the nearest Hyundai dealer for assistance.

WARNING

Do not remove the radiator cap when the engine is hot. This may allow engine coolant to be blown out of the opening and cause serious burns.

6. If you cannot find the cause of the overheating, wait until the engine temperature has returned to normal. Then, if engine coolant has been lost, carefully remove the radiator cap and add engine coolant to bring the fluid level in the reservoir up to the halfway mark.
7. Proceed with caution, keeping alert for further signs of overheating. If overheating happens again, call a Hyundai dealer for assistance.

CAUTION:

Serious loss of engine coolant indicates there is a leak in the cooling system and this should be checked as soon as possible by a Hyundai dealer.

ZL050A1-A

SPARE TIRE

The following instructions for the temporary spare tire should be observed:

1. Check inflation pressure as soon as practical after installing the spare tire, and adjust to the specified pressure. The tire pressure should be periodically checked and maintained at the specified pressure while the tire is stored.

Spare Tire Pressure

| | |
|--------------------|------------------|
| Tire Size | T105/70D14 |
| Inflation Pressure | 60 psi (414 kPa) |

2. The spare tire should only be used temporarily and should be returned to the luggage compartment as soon as the original tire can be repaired or replaced.
3. Continuous use at speeds of over 80 km/h (50 mph) is not recommended.
4. As the temporary spare tire is specifically designed for your car, it should not be used on any other vehicle.
5. The temporary spare tire should not be used on any other wheels, nor should standard tires, snow tires, wheel covers or trim rings be used with the temporary spare wheel. If such use is attempted, damage to these items or other car components may occur.

6. The temporary spare tire pressure should be checked once a month while the tire is stored.

CAUTION:

- o Do not use snow chains with your temporary spare tire.
- o Do not use more than one temporary spare tire at a time.

ZD050C1-A

Handling the Spare Tire

Remove the installation bolt to remove the spare tire. To replace the spare tire in its storage compartment, tighten the bolt firmly with your fingers until there is no more play in the spare tire.

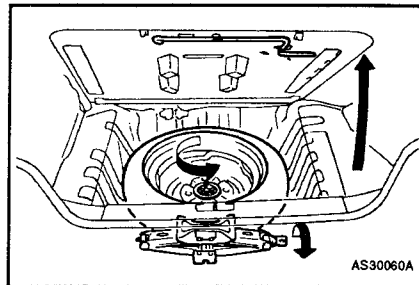

WHAT TO DO IN AN EMERGENCY

AD060A1-A

IF YOU HAVE A FLAT TIRE

If a tire goes flat while you are driving:

1. Take your foot off the accelerator pedal and let the car slow down while driving straight ahead. Do not apply the brakes immediately or attempt to pull off the road as this may cause a loss of control. When the car has slowed to such a speed that it is safe to do so, brake carefully and pull off the road. Drive off the road as far as possible and park on firm, level ground. If you are on a divided highway, do not park in the median area between the two traffic lanes.
2. When the car is stopped, turn on your emergency hazard flashers, set the parking brake and put the transaxle in "P" (automatic) or reverse (manual transaxle).
3. Have all passengers get out of the car. Be sure they all get out on the side of the car that is away from traffic.
4. Change the tire following the instructions provided on the following pages.

ZD070A1-A

CHANGING A FLAT TIRE

The procedure described on the following pages can be used to rotate tires as well as to change a flat tire. When preparing to change a flat tire, check to be sure the gear selector lever is in "P" (automatic) or reverse gear (manual transaxle) and that the parking brake is set, then:

ZD070B1-A

1. Obtain Spare Tire and Tool

Remove the spare tire and take out the jack, jack handle, and tool bag from the trunk.

NOTE:

The jack handle is located beneath the luggage mat in the vehicle trunk.

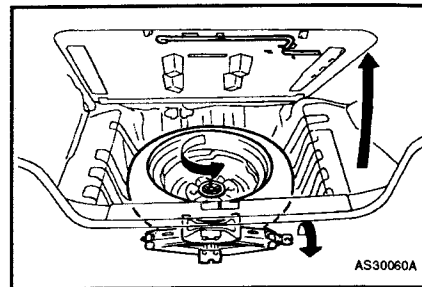
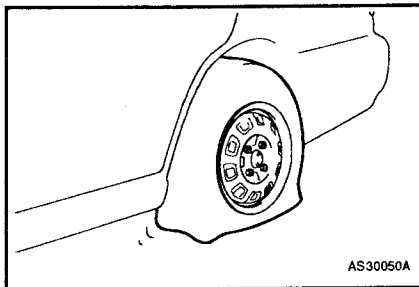

WHAT TO DO IN AN EMERGENCY

ZD070D1-A

2. Block the Wheel

Block the wheel that is diagonally opposite from the flat to keep the vehicle from rolling when the car is raised on the jack.

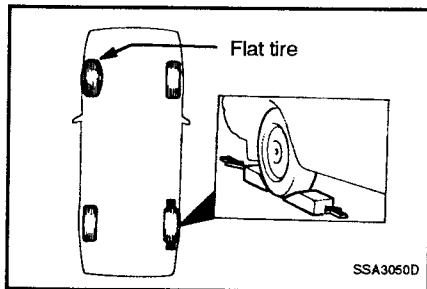

ZD070F1-A

3. Loosen Wheel Nuts

The wheel nuts should be loosened slightly before raising the car. To loosen the nuts, turn the wrench handle counterclockwise. When doing this, be sure that the socket is seated completely over the nut so it cannot slip off. For maximum leverage, position the wrench so the handle is to the right as shown in the drawing. Then, while holding the wrench near the end of the handle, pull up on it with steady pressure. Do not remove the nuts at this time. Just loosen them about one-half turn.

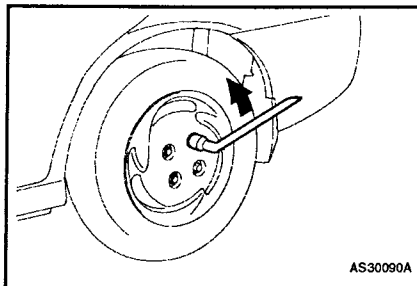

ZD070G1-A

4. Put the Jack in Place

The base of the jack should be placed on firm, level ground. The jack should be positioned as shown in the drawing.

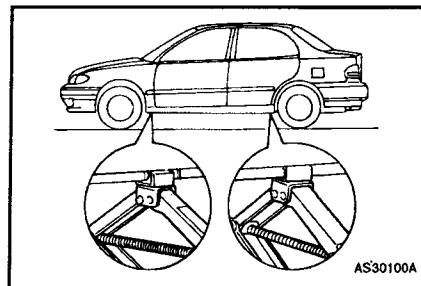

WHAT TO DO IN AN EMERGENCY

ZD070H2-A

5. Raising the Car

Install the jack handle into the jack as shown in the drawing. To raise the vehicle, turn the jack handle clockwise. As the jack begins to raise the vehicle, double check that it is properly positioned and will not slip. If the jack is on soft ground or sand, you may find it necessary to place a board, brick, flat stone or other object under the base of the jack to keep it from sinking.

Raise the car high enough so that the fully inflated spare tire can be installed. To do this, you will need more ground clearance than is required to remove the flat tire.

WARNING

Do not get under the car when it is supported by the jack! The vehicle could fall and cause serious injury or death. No one should stay in the car while the jack is being used.

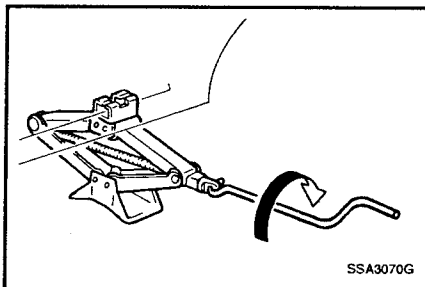

ZD070I3-A

6. Changing Wheels

Use the wrench to loosen the wheel nuts, then remove them with your fingers. Remove the wheel cover (if installed) from the wheel and slide the wheel off the studs and lay it flat so it cannot roll away. To put the wheel on the hub, pick up the spare tire, line up the holes with the studs and slide the wheel onto them. If this is difficult, tip the wheel slightly and get the top hole in the wheel lined up with the top stud. Then jiggle the wheel back and forth until the wheel can be slid over the other studs.

WARNING

Wheel covers may have sharp edges. Handle them carefully to avoid possible severe injury.

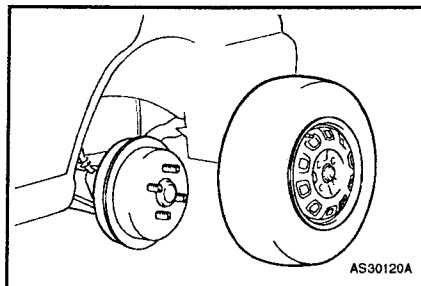

Before putting the wheel into place, be sure that there is nothing on the hub or wheel (such as mud, tar, gravel, etc.) that interferes with the wheel fitting solidly against the hub. If there is, remove it. If there is not good contact on the mounting surface between the wheel and hub, the wheel nuts could come loose and cause the loss of a wheel. Loss of a wheel may result in loss of control of the vehicle. This may cause serious injury or death.

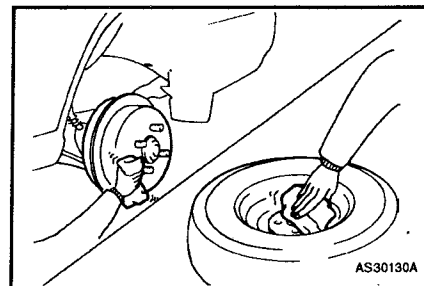

WHAT TO DO IN AN EMERGENCY

ZD070J1-A

7. Re-install Wheel Nuts

To re-install the wheel cover, hold it on the wheel and put the wheel nuts on the studs and tighten them finger tight. The nuts should be installed with their small diameter ends directed inward. Jiggle the tire to be sure it is completely seated, then tighten the nuts with your fingers again.

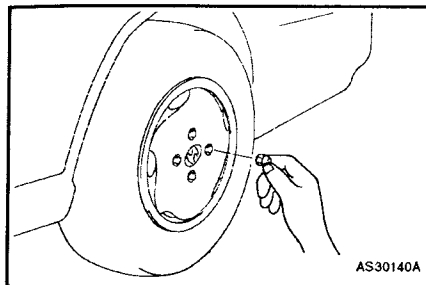

ZD070K2-A

8. Lower Vehicle and Tighten Nuts

Lower the car to the ground by turning the jack handle counterclockwise. Then position the wrench as shown in the drawing and tighten the wheel nuts. Be sure the socket is seated completely over the nut. Do not stand on the wrench or use an extension pipe over the wrench handle. Go around the wheel tightening every other nut until they are all tight. Then double-check each nut for tightness. After changing wheels, have a technician tighten the wheel nuts to their proper torque as soon as possible.

Wheel nut tightening torque:

Steel wheel & aluminium alloy wheel:
900-1,100 kg.cm (65-80 lb.ft)

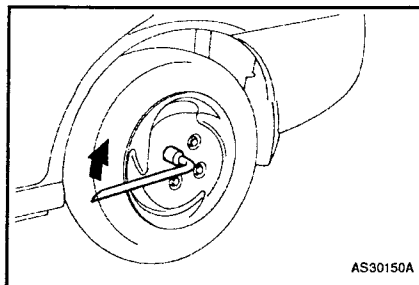

ZD070M1-A

AFTER CHANGING WHEELS

If you have a tire gauge, remove the valve cap and check the air pressure. If the pressure is lower than recommended, drive slowly to the nearest service station and inflate to the correct pressure. If it is too high, adjust it until it is correct. Always re-install the valve cap after checking or adjusting tire pressure. If the cap is not replaced, air may leak from the tire. If you lose a valve cap, buy another and install it as soon as possible. After you have changed wheels, always secure the flat tire in its place in the trunk and return the jack, jack handle, and tools to their proper storage locations.

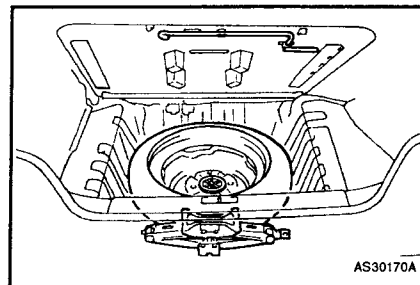

WHAT TO DO IN AN EMERGENCY

ZD080A1-A

IF YOUR CAR MUST BE TOWED CAUTION:

Your car can be damaged if towed incorrectly!

If your car has to be towed, it should be done by your Hyundai dealer or a commercial tow truck service. This will help assure that your car is not damaged in towing. Also, professionals are generally aware of state and local laws governing towing. In any case, show this information to the tow truck operator. Be sure that a safety chain system is used and that all state and local laws are observed.

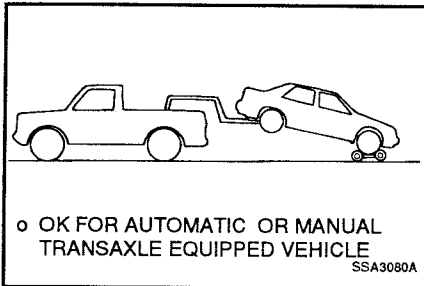

ZD090A1-A

TOWING A CAR WITH MANUAL TRANSAXLE

- o If the car is being towed with the rear wheels on the ground, be sure the parking brake is released.
- o If the car is being towed with the front wheels on the ground, be sure that the transaxle is in neutral. Also, be sure that the ignition key is in the "ACC" position. This is necessary to prevent damage to the steering lock mechanism, which is not designed to hold the front wheels straight while the car is being towed.
- o If any of the loaded wheels or suspension components are damaged, a towing dolly must be used.

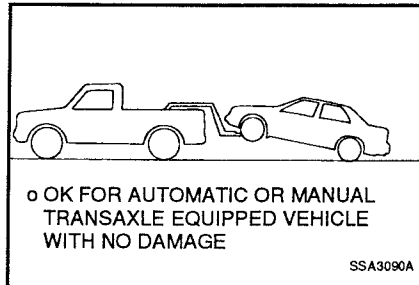

ZD100A1-A

TOWING A CAR WITH AUTOMATIC TRANSAXLE CAUTION:

A car with an automatic transaxle should never be towed from the rear with the front wheels on the ground. This can cause serious damage to the transaxle. If the car must be towed from the rear, a towing dolly must be used under the front wheels.

- o If the car is being towed with the rear wheels on the ground, be sure the parking brake is released.
- o If the car is being towed with all four wheels on the ground, it can be towed only from the front. Be sure that the transaxle is in neutral. Do not tow at speeds greater than 30 mph (50 kph) and for more than 15 miles (25 km).

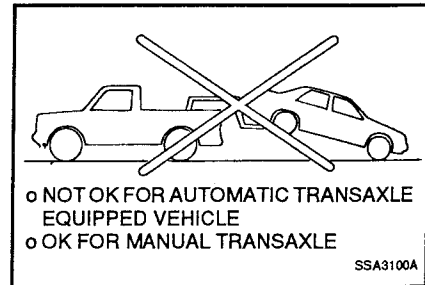

WHAT TO DO IN AN EMERGENCY

Be sure the steering is unlocked by placing the key in the "ACC" position. A driver must be in the towed vehicle to operate the steering and brakes.

NOTE:

Before towing, check the level of the transaxle fluid. If it is below the "HOT" mark on the dipstick, add fluid. If you cannot add fluid, a towing dolly must be used as described above.

ZD110A1-A

EMERGENCY TOWING

For emergency towing when no commercial tow vehicle is available, attach a tow cable, chain or strap to one of the tie-down hooks under the front of your car. Do not attempt to tow your vehicle in this manner on any unpaved surface. This may result in serious damage to your car.

Nor should it be attempted if the wheels, drive train, axles, steering or brakes are damaged. Before towing, be sure the transaxle is in neutral and the key is in "ACC" (with the engine off) or in the "ON" position (with the engine running). A driver must be in the towed car to steer it and operate the brakes.

ZD120A1-A

IF YOU LOSE YOUR KEYS

If you lose your keys, many Hyundai dealers can make you a new key if you have your key number.

If you lock the keys inside your car and you cannot obtain a new key, many Hyundai dealers can use special tools to open the door for you.

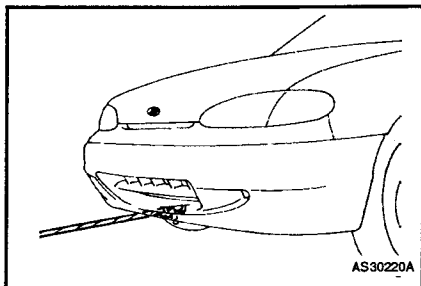
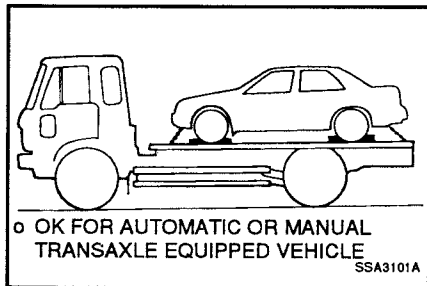

ZE010A1-A

4. KEEPING THOSE GOOD LOOKS

Corrosion Prevention & Appearance Care

CORROSION PREVENTION AND APPEARANCE CARE

ZE020A1-A

PROTECTING YOUR HYUNDAI FROM CORROSION

By using the most advanced design and construction practices to combat corrosion, Hyundai produces cars of the highest quality. However, this is only part of the job. To achieve the long-term corrosion resistance your Hyundai can deliver, the owner's cooperation and assistance is also required.

ZE020B1-A

Common Causes of Corrosion

The most common causes of corrosion on your car are:

- o Road salt, dirt and moisture that is allowed to accumulate underneath the car.
- o Removal of paint or protective coatings by stones, gravel, abrasion or minor scrapes and dents which leave unprotected metal exposed to corrosion.

ZE020C1-A

High-Corrosion Areas

If you live in an area where your car is regularly exposed to corrosive materials, corrosion protection is particularly important. Some of the common causes of accelerated corrosion are road salts, dust control chemicals, ocean air and industrial pollution.

ZE020D1-A

Moisture Breeds Corrosion

Moisture creates the conditions in which corrosion is most likely to occur. For example, corrosion is accelerated by high humidity, particularly when temperatures are just above freezing. In such conditions, the corrosive material is kept in contact with the car surfaces by moisture that is slow to evaporate.

Mud is a particular enemy of corrosion protection because it is slow to dry and holds moisture in contact with the vehicle. Even though the mud appears to be dry, it can still retain moisture and promote corrosion.

High temperatures can also accelerate corrosion of parts that are not properly ventilated so the moisture can be dispersed. For all these reasons, it is particularly important to keep your car clean and free of mud or accumulations of other materials. This applies not only on the visible surfaces but particularly to the underside of the car.

ZE030A1-A

TO HELP PREVENT CORROSION

You can help prevent corrosion from getting started by observing the following:

ZE030B1-A

Keep Your Car Clean

The best way to prevent corrosion is to keep your car clean and free of corrosive materials. Attention to the underside of the car is particularly important.

- o If you live in a high-corrosion area — where road salts are used, near the ocean, areas with industrial pollution, acid rain, etc.—You should take extra care to prevent corrosion. In winter, hose off the underside of your car at least once a month and be sure to clean the underside thoroughly when winter is over.
- o When cleaning underneath the car, give particular attention to the components under the fenders and other areas that are hidden from view. Do a thorough job; just dampening the accumulated mud rather than washing it away will accelerate corrosion rather than prevent it. Water under high pressure and steam are particularly effective in removing accumulated mud and corrosive materials.
- o When cleaning lower door panels, rocker panels and frame members, be sure that drain holes are kept open so that moisture can escape and not be trapped inside to accelerate corrosion.

CORROSION PREVENTION AND APPEARANCE CARE

ZE030C1-A

Keep Your Garage Dry

Don't park your car in a damp, poorly ventilated garage. This creates a favorable environment for corrosion. This is particularly true if you wash your car in the garage or drive it into the garage when it is still wet or covered with snow, ice or mud. Even a heated garage can contribute to corrosion unless it is well ventilated so moisture is dispersed.

ZE030D1-A

Keep Paint and Trim in Good Condition

Scratches or chips in the finish should be covered with "touch-up" paint as soon as possible to reduce the possibility of corrosion. If bare metal is showing through, the attention of a qualified body and paint shop is recommended.

ZE030E1-A

Don't Neglect the Interior

Moisture can collect under the floor mats and carpeting to cause corrosion. Check under the mats periodically to be sure the carpeting is dry. Use particular care if you carry fertilizers, cleaning materials or chemicals in the car. These should be carried only in proper containers and any spills or leaks should be cleaned up, flushed with clear water and thoroughly dried.

ZE040A1-A

WASHING AND WAXING

Washing Your Hyundai

Never wash your car when the surface is hot from being in the sun. Always wash your car in the shade.

Wash your car frequently. Dirt is abrasive and can scratch the paint if it is not removed. Air pollution or acid rain may damage the paint and trim through chemical action if pollutants are allowed to remain in contact with the surface. If you live near the ocean or in an area where road salts or dust control chemicals are used, you should pay particular attention to the underside of the car. Start by rinsing the car to remove dust and loose dirt. In winter, or if you have driven through mud or muddy water, be sure to thoroughly clean the underside as well. Use a hard direct stream of water to remove accumulations of mud or corrosive materials. Use a good quality car-washing solution and follow the manufacturer's directions on the package. These are available at your Hyundai dealer or auto parts outlet. Don't use strong household detergents, gasoline, strong solvents or abrasive cleaning powders as these may damage the finish. Use a clean sponge or cloth, rinse it frequently and don't damage the finish by rubbing too hard. For stubborn spots, dampen them frequently and remove them a little at a time.

To clean whitewall tires, use a stiff brush or soap-impregnated steel-wool scouring pad.

To clean plastic wheel covers, use a clean sponge or soft cloth and water.

To clean cast aluminum alloy wheels, use a mild soap or detergent. Do not use abrasive cleaners. Protect the bare metal surfaces by cleaning, polishing and waxing. Because aluminum is subject to corrosion, be sure to give aluminum alloy wheels special attention in winter. If you drive on salted roads, clean the wheels thoroughly afterwards.

After washing, be sure to rinse thoroughly. If soapy water dries on the finish, streaking will result.

When the weather is warm and the humidity low, you may find it necessary to rinse each section immediately after washing to avoid streaking.

After rinsing, dry the car using a damp chamois or soft, absorbent cloth. The reason for drying the car is to remove water from the car so it will dry without water spots. Don't rub, this can damage the finish.

If you find any nicks or scratches in the paint, use touch-up paint to cover them to prevent corrosion.

CORROSION PREVENTION AND APPEARANCE CARE

ZE040B1-A

Spot Cleaning

Don't use gasoline, strong solvents or corrosive cleaning agents. These can damage the finish of the car. To remove road tar, use turpentine on a clean, soft cloth. Be gentle.

To remove dead insects or tree sap, use warm water and mild soap or car-washing solution. Soak the spot and rub gently. If the paint has lost its luster, use a commercial car-cleaning polish.

ZE040C1-A

Polishing and Waxing

Always wash and dry the car before polishing or waxing or using a combination cleaner and wax. Use a good quality commercial product and follow the manufacturer's directions on the container. Polish and wax the bright trim pieces as well as the paint.

ZE040D1-A

When to Wax Again

You should polish and wax the car again when water no longer beads on a clean surface but spreads out over a larger area.

ZE040E1-A

Maintaining Bumpers

Special precautions must be observed to preserve the appearance of the bumpers on your Hyundai. They are:

- o Be careful not to spill battery electrolyte or hydraulic brake fluid on the bumpers. If you do, wash it off immediately with clean water.
- o Be gentle when cleaning the bumper surfaces. They are made of soft plastic and the surface can be damaged if mistreated. Do not use abrasive cleaners. Use warm water and mild soap or car-washing solution.
- o Do not expose the bumpers to high temperatures. For example, if you have your car repainted, do not leave the bumpers on the car if the car is going to be placed in a high-temperature paint booth.

ZE050A1-A

CLEANING THE INTERIOR

To Clean the Vinyl Upholstery

To clean the vinyl upholstery, first remove loose dirt and dust with a vacuum cleaner. Then apply a solution of mild soap or detergent and water using a clean sponge or soft cloth. Allow this to stay on the surface to loosen the dirt, then wipe with a clean damp sponge or cloth. If all the dirt stains are not removed, repeat this procedure until the upholstery is clean. Do not use gasoline, solvent, paint thinner or other strong cleaners.

ZE050B1-A

Cleaning the Carpets

Use a foam-type carpet cleaner. Cleaners of this type are available in aerosol cans in liquid form or powder. Read the instructions and follow them exactly. Using a vacuum cleaner with the appro-

prate attachment, remove as much dirt from the carpets as possible. Apply the foam following the manufacturer's directions, then rub in overlapping circles. Do not add water. These cleaners work best when the carpet is kept as dry as possible.

ZE050C1-A

Cleaning the Seat Belts

To clean the seat belts, use a cloth or sponge with mild soap or detergent and warm water. Do not use strong detergents, dye, bleach or abrasive materials on the seat belts as this may weaken the fabric.

While cleaning the belts, inspect them for excessive wear, cuts, fraying or other signs of damage and replace them if necessary.

ZE050D1-A

Cleaning the Windows

You may use any household window cleaner on the windows. However, when cleaning the inside of the rear window be careful not to damage the rear window defroster wiring.

ZE050E1-A

Any Questions?

If you have any questions about the care of your car, consult your Hyundai dealer.

ZF010A1-A

5. THE KEY TO TROUBLE-FREE OPERATION

Vehicle Maintenance Requirements

VEHICLE MAINTENANCE REQUIREMENTS

ZF020A1-A

MAINTENANCE AND SERVICE REQUIREMENTS

To assure that you receive the greatest number of miles of satisfying operation from your Hyundai, certain maintenance procedures must be performed. Although careful design and engineering have reduced these to a minimum, those that are required are of the utmost importance.

It is your responsibility to have these maintenance procedures performed to comply with the terms of the warranties covering your new Hyundai. The Owner's Handbook supplied with your new vehicle provides further information about these warranties.

ZF020B1-A

Maintenance Requirements

The maintenance required for your Hyundai can be divided into three main areas:

- o Specified scheduled procedures
- o General everyday checks
- o Do-it-yourself maintenance

ZF020C1-A

Specified Scheduled Procedures

These are the procedures such as inspections, adjustments and replacements that are listed in the maintenance charts starting on page 5-3. These procedures must be performed at the intervals shown in the maintenance schedule to assure that your warranty remains in effect.

Although it is strongly recommended that they be performed by the factory-trained technicians at your Hyundai dealer, these procedures may be performed at any qualified service facility.

It is suggested that genuine Hyundai service parts be used for any required repairs or replacements. Other parts of equivalent quality may be used without affecting your warranty coverage but you should always be sure these are equivalent to the quality of the original Hyundai parts. Your Owner's Handbook provides further information about your warranty coverage.

ZF020D1-A

General Everyday Checks

These are the everyday checks you should perform each time you drive your Hyundai or when you fill the fuel tank. A list of these items will be found on page 6-4.

ZF020E1-A

Do-It-Yourself Maintenance

If you are mechanically inclined, own a few tools that are required and want to take the time to do so, you can inspect and service a number of items. For more information about doing it yourself, see Section 6.

ZF020F1-A

A Few Tips

- o Whenever you have your Hyundai serviced, keep copies of the service records in your glovebox. This will help assure that you can document that the required procedures have been performed to keep your warranties in effect. This is especially important when service is not performed at an authorized Hyundai dealer.
- o If you choose to do your own maintenance and repairs, you may find it helpful to have an official Hyundai Shop Manual. A copy of this publication may be purchased at your Hyundai dealer's parts department.

ZF030A2-A

SCHEDULED MAINTENANCE REQUIREMENTS

- o Inspection should be performed any time a malfunction is experienced or suspected.
- o Receipts for all emission control system services should be retained to demonstrate compliance with conditions of the emissions system warranty.
- o After 70 months or 60,000 miles (96,000 km), continue to follow the prescribed maintenance and intervals periodically.
- o For severe usage maintenance requirements, see page 5-5 of this section.

VEHICLE MAINTENANCE REQUIREMENTS

AF040A1-A

SCHEDULED MAINTENANCE

The following maintenance services must be performed to assure good emission control and performance. Keep receipts for all vehicle emission services to protect your emission warranty.

Where both mileage and time are shown, the frequency of service is determined by whichever occurs first.

AF040B1-A

R : REPLACE I : INSPECT AND, AFTER INSPECTION, CLEAN, ADJUST, REPAIR OR REPLACE IF NECESSARY

| NO. | DESCRIPTION | MILES X 1000 | 7.5 | 15 | 22.5 | 30 | 37.5 | 45 | 52.5 | 60 |
|------------------------|---|-------------------|-----|----|------|----|------|----|------|----|
| | | KILOMETERS X 1000 | 12 | 24 | 36 | 48 | 60 | 72 | 84 | 96 |
| | | MONTHS | 5 | 10 | 20 | 30 | 40 | 50 | 60 | 70 |
| EMISSION CONTROL ITEMS | | | | | | | | | | |
| 1 | ENGINE OIL AND FILTER | | R | R | R | R | R | R | R | R |
| 2 | FUEL FILTER | | | | | | | | R | |
| 3 | FUEL LINES AND CONNECTIONS | | | | | | | | I | |
| 4 | VACUUM, CRANKCASE VENTILATION HOSES | | | | | | | | I | |
| 5 | FUEL HOSE, VAPOR HOSE & FUEL FILLER CAP | | | | | | | | I | |
| 6 | AIR CLEANER FILTER | | | | | R | | | | R |
| 7 | SPARK PLUGS | | | | | R | | | | R |

VEHICLE MAINTENANCE REQUIREMENTS

AF040C1-A

R : REPLACE I : INSPECT AND, AFTER INSPECTION, CLEAN, ADJUST, REPAIR OR REPLACE IF NECESSARY

| NO. | DESCRIPTION | MILES X 1000 | 7.5 | 15 | 22.5 | 30 | 37.5 | 45 | 52.5 | 60 |
|---------------|--|-------------------|-----|----|------|----|------|----|------|----|
| | | KILOMETERS X 1000 | 12 | 24 | 36 | 48 | 60 | 72 | 84 | 96 |
| | | MONTHS | 5 | 10 | 20 | 30 | 40 | 50 | 60 | 70 |
| GENERAL ITEMS | | | | | | | | | | |
| 1 | DRIVE BELT (ENGINE COOLANT PUMP AND GENERATOR) | | | I | | | I | | | R |
| 2 | ENGINE COOLANT (every 2 years) | | | | | R | | | | R |
| 3 | TIMING BELT | | | | | I | | | | R |
| 4 | MANUAL TRANSAXLE OIL | | | | | I | | | | I |
| 5 | AUTO TRANSAXLE OIL | | | I | | R | | I | | R |
| 6 | BRAKE FLUID | | | | | R | | | | R |
| 7 | BRAKE HOSES, LINES | | | I | | I | | I | | I |
| 8 | REAR BRAKE DRUMS/LININGS/PARKING BRAKE | | | | | I | | | | I |
| 9 | BRAKE PADS, CALIPERS, ROTORS | | | I | | I | | I | | I |
| 10 | EXHAUST PIPE CONNECTIONS, MUFFLER | | | | | I | | | | I |
| 11 | STEERING GEAR RACK, LINKAGE & BOOTS | | | | | I | | | | I |
| 12 | WHEEL BEARING GREASE | | | | | I | | | | I |
| 13 | DRIVESHAFTS & BOOTS | | | I | | I | | I | | I |
| 14 | SUSPENSION BALL JOINTS & DUST COVERS | | | | | I | | | | I |
| 15 | BOLTS & NUTS ON CHASSIS & BODY | | | | | I | | | | I |

VEHICLE MAINTENANCE REQUIREMENTS

AF050A1-A

MAINTENANCE UNDER SEVERE USAGE CONDITIONS

The following items must be serviced more frequently on cars normally used under severe driving conditions. Refer to the chart below for the appropriate maintenance intervals.

I : Inspect, correct or replace if necessary. R : Replace

| MAINTENANCE ITEM | MAINTENANCE OPERATION | MAINTENANCE INTERVALS | DRIVING CONDITION |
|--|-----------------------|--|-------------------|
| ENGINE OIL AND FILTER | R | EVERY 3,000 MILES(4,800 KM) OR 3 MONTHS | A, B, C, F |
| AIR CLEANER FILTER | R | MORE FREQUENTLY | C, E |
| SPARK PLUGS | R | EVERY 24,000 MILES (40,000 KM) OR 18 MONTHS | B |
| BRAKE PADS, CALIPERS, ROTORS | I | MORE FREQUENTLY | C, D, G |
| REAR BRAKE DRUMS/LININGS | I | MORE FREQUENTLY | C, D, G |
| STEERING GEAR RACK, LINKAGE & BOOTS | I | MORE FREQUENTLY | C, D, E, F, G |
| DRIVESHAFTS & BOOTS | I | EVERY 7,500 MILES (12,000 KM) OR 6 MONTHS | C, E, F |
| AUTOMATIC TRANSAXLE OIL | R | EVERY 15,000 MILES (24,000 KM) OR 10 MONTHS | B, G |

SEVERE DRIVING CONDITIONS

- A - Repeated short distance driving
- C - Driving in dusty conditions
- E - Driving in sandy areas
- G - Driving in mountainous areas

- B - Extensive idling
- D - Driving in areas using salt or other corrosive materials or in very cold weather
- F - More than 50% driving in heavy city traffic during hot above 90 °F (32 °C)

VEHICLE MAINTENANCE REQUIREMENTS

ZF060A1-A

EXPLANATION OF SCHEDULED MAINTENANCE ITEMS

o Engine oil and filter

The engine oil and filter should be changed at those intervals specified in the maintenance schedule. If the car is being driven in severe conditions, more frequent oil and filter changes are required.

ZF060G1-A

o Fuel lines and connections

Check the fuel lines and connections for leakage and damage. Replace any damaged or leaking parts immediately.

ZF060B1-A

o Fuel filter

A clogged filter can limit the speed at which the vehicle may be driven, damage the emission

system and cause hard starting. If an excessive amount of foreign matter accumulates in the fuel tank, the filter may require replacement more frequently.

After installing a new filter, run the engine for several minutes, and check for leaks at the connections.

ZF060H1-A

o Vacuum, and crankcase ventilation hoses

Inspect the surface of hoses for evidence of heat and/or mechanical damage. Hard and brittle rubber, cracking, tears, cuts, abrasions, and excessive swelling indicate deterioration. Particular attention should be paid to examine those hose surfaces nearest to high heat sources, such as the exhaust manifold.

Inspect the hose routing to assure that the hoses do not come in contact with any heat source, sharp edges or moving component which might cause heat damage or mechanical wear. Inspect all hose connections, such as clamps and couplings, to make sure they are secure, and that no leaks are present. Hoses should be replaced immediately if there is any evidence of deterioration or damage.

ZF060I1-A

o Fuel hose, vapor hose and fuel filler cap

The fuel hose, vapor hose and fuel filler cap should be inspected at those intervals specified in the maintenance schedule. Make sure that a new fuel hose, vapor hose or fuel filler cap is correctly replaced. Consult your Hyundai dealer if you have any questions.

ZF060J1-A

o Air cleaner filter

A genuine Hyundai part is recommended for replacement of the air cleaner filter.

ZF060M1-A

o Spark plugs

Make sure to install new spark plugs of the correct heat range.

ZF060C1-A

o Drive belts

Inspect all drive belts (water pump and alternator) for evidence of cuts, cracks, excessive wear or oiliness, and replace if necessary. Drive belts should be checked periodically for proper tension and adjusted as necessary.

VEHICLE MAINTENANCE REQUIREMENTS

ZF070F1-A

o Engine coolant

The engine coolant should be changed at those intervals specified in the Vehicle Maintenance Requirements Section.

ZF070G1-A

o Timing belt

Inspect all parts related with the timing belt for damage and deformation. Replace any damaged parts.

ZF070H1-A

o Manual transaxle oil

Check manual transaxle oil according to the maintenance schedule.

NOTE:

If the oil level is low, check for possible leaks before adding oil. Do not overfill.

ZF070I3-A

o Automatic transaxle fluid

The fluid level should be in the "HOT" range of the dipstick, after engine and transaxle are at normal operating temperature. Check the Automatic Transaxle Fluid level with the engine running and the transaxle in neutral, with the parking brake properly applied. Use GENUINE HYUNDAI ATF AUTOMATIC TRANSAXLE FLUID, MOPAR ATF PLUS TYPE 7176 or DIAMOND ATF SP, when adding or changing fluid.

ZF070J1-A

o Brake hoses and lines

Visually check for proper installation, chafing, cracks, deterioration and any leakage. Replace any deteriorated or damaged parts immediately.

ZF070K1-A

o Brake fluid

Check brake fluid level in the brake fluid reservoir. The level should be between "MIN" and "MAX" marks on the side of the reservoir. Use only hydraulic brake fluid conforming to DOT 3.

ZF070L1-A

o Rear brake drums and linings

Check for scoring, burning, leaking fluid, broken parts, and excessive wear.

ZF070M1-A

o Brake pads, calipers and rotors

Check the pads for excessive wear, discs for run out and wear, and calipers for fluid leakage.

ZF070N1-A

o Parking brake

Inspect the parking brake system such as parking brake lever, cables, and so on. For detailed service procedures, refer to the Shop Manual.

ZF070O1-A

o Exhaust pipe connections, muffler and suspension bolts

Check the exhaust pipe, muffler, and suspension connections for looseness or damage.

ZF070P1-A

o Steering gear box, linkage and boots

With the car stopped and engine off, check for excessive free-play in the steering wheel. Check the linkage for bends or damage. Check the dust boots and ball joints for deterioration, cracks, or damage. Replace any damaged parts.

ZF070Q1-A

o Wheel bearing grease

Check the wheel bearings and grease according to the maintenance schedule. For inspection procedures, see Shop Manual.

ZF070R1-A

o Driveshafts and boots

Check the drive shafts, boots and clamps for cracks, deterioration, or damage. Replace any damaged parts and, if necessary, repack the grease.

VEHICLE MAINTENANCE REQUIREMENTS

AF070S1-A

o Suspension ball joints & dust covers

Check the suspension ball joints & dust covers for looseness or damage.

AF070T1-A

o Bolts & nuts on chassis & body

Check the bolts & nuts on chassis & body for looseness.

ZG000A1-A

6. SATURDAY MECHANICS

Do-It-Yourself Maintenance

DO-IT-YOURSELF MAINTENANCE

AG610A1-A

ENGINE COMPARTMENT (For Multiport Fuel Injection)

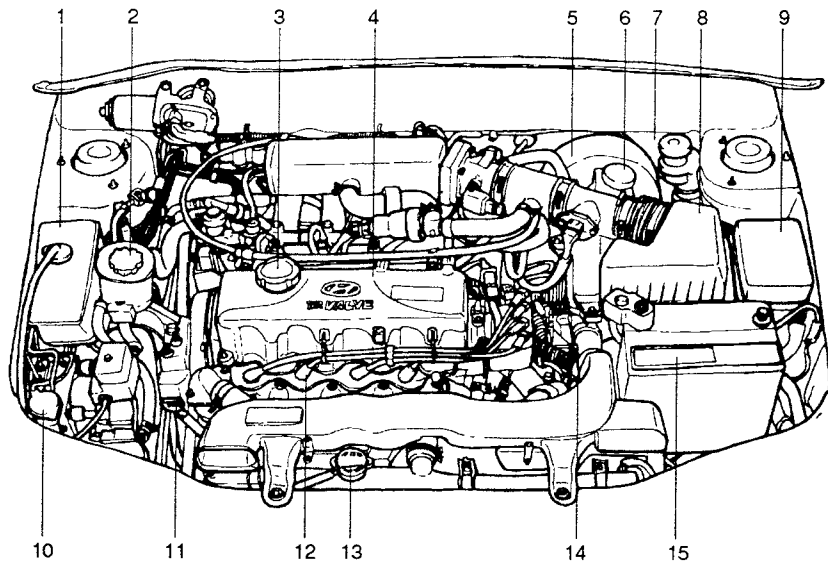

CAUTION:

When inspecting or servicing the engine, you should handle tools and other heavy objects carefully so that the plastic rocker cover of the engine is not damaged.

AS60010A

1. Engine coolant reservoir cap
2. Power steering fluid reservoir
3. Engine oil filler cap
4. Rocker cover
5. Brake booster

6. Brake fluid reservoir
7. Clutch fluid reservoir (If installed)
8. Air cleaner
9. Relay box
10. Windshield washer fluid reservoir cap

11. Engine oil level dipstick
12. Spark plug
13. Radiator cap
14. Automatic transaxle fluid level dipstick
(Automatic T/A only)
15. Battery

DO-IT-YOURSELF MAINTENANCE

AG010C1-A

ENGINE COMPARTMENT (For DOHC)

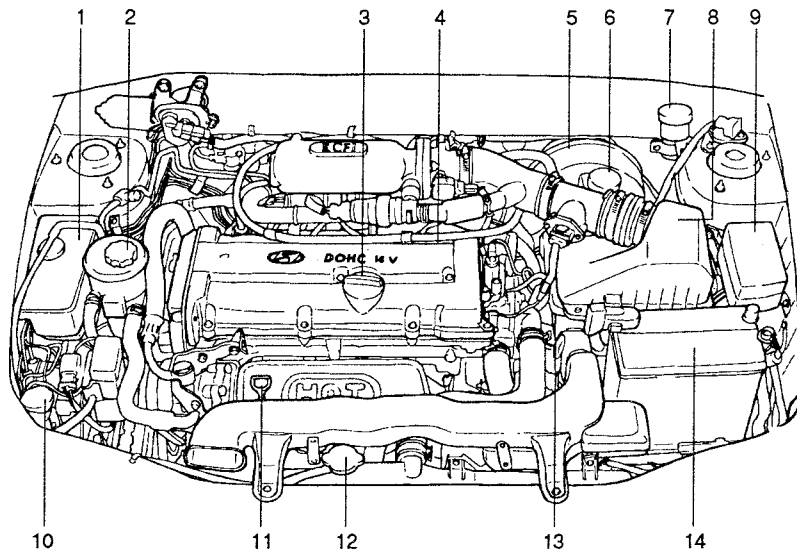

CAUTION:

When inspecting or servicing the engine, you should handle tools and other heavy objects carefully so that the plastic rocker cover of the engine is not damaged.

1. Engine coolant reservoir cap
2. Power steering fluid reservoir
3. Engine oil filler cap
4. Rocker cover
5. Brake booster
6. Brake fluid reservoir

7. Clutch fluid reservoir (if installed)
8. Air cleaner
9. Relay box
10. Windshield washer fluid reservoir cap
11. Engine oil level dipstick
12. Radiator cap

13. Automatic transxle fluid level dipstick (Automatic T/A only)
14. Battery

ATA6011A

DO-IT-YOURSELF MAINTENANCE

ZG020A1-A

GENERAL EVERYDAY CHECKS

Engine Compartment

The following should be checked regularly:

- o Engine oil level and condition
- o Transaxle fluid level and condition
- o Brake reservoir fluid level
- o Clutch reservoir fluid level
- o Engine coolant level
- o Windshield washer fluid level
- o Accessory drive belt condition
- o Engine coolant hose condition
- o Air cleaner filter condition
- o Exhaust system condition
- o Fluid leaks (on or below components)
- o Power steering fluid level and condition
- o Battery condition

ZG020B1-A

Vehicle Exterior

The following should be checked monthly:

- o Overall appearance and condition
- o Wheel condition and wheel nut tightness
- o Exhaust system condition
- o Light condition and operation
- o Windshield glass condition
- o Wiper blade condition
- o Paint condition and corrosion
- o Fluid leaks
- o Door and hood lock condition
- o Tire pressure and condition (including spare)

ZG020C1-A

Vehicle Interior

The following should be checked each time when the vehicle is driven:

- o Light operation
- o Windshield wiper operation
- o Horn operation
- o Defroster, heater operation (and air conditioning, if equipped)
- o Steering operation and condition
- o Mirror condition and operation
- o Turn signal operation
- o Accelerator pedal operation
- o Brake operation, including parking brake
- o Manual transaxle operation, including clutch operation
- o Automatic transaxle operation, including "Park" mechanism operation
- o Seat control condition and operation
- o Seat belt condition and operation
- o Sun visor operation

If you notice anything that does not operate correctly or appear to be functioning correctly, inspect it carefully and seek assistance from your Hyundai dealer if service is needed.

DO-IT-YOURSELF MAINTENANCE

ZG030A1-A

CHECKING THE ENGINE OIL

Engine oil is essential to the performance and service of the engine. It is suggested that you check the oil level at least once a week in normal use and more often if you are on a trip or driving in severe conditions.

ZG030B1-A

Recommended Oil

SH, SG or SG/CD (API) multi-grade and fuel efficient oil is recommended.

ZG030C1-A

To Check the Oil Level

Before checking the oil, warm up the engine to normal operating temperature and be sure it is parked on level ground. Turn the engine off.

Wait a minute, then remove the dipstick, wipe it off, fully reinsert the dipstick and withdraw it again. Then note the highest level of oil has reached on the dipstick. It should be between the upper ("F") and lower ("L") range.

ZG030D1-A

Adding Oil

If the oil level is close to or below the "L" mark, add oil until it reaches the "F" mark. To add oil:

1. Remove the oil filler cap by turning it counter-clockwise.
2. Add oil, then check the level again. Do not overfill.
3. Replace the cap by turning it clockwise.

The distance between the "F" and "L" marks is equal to about 1 quart of oil.

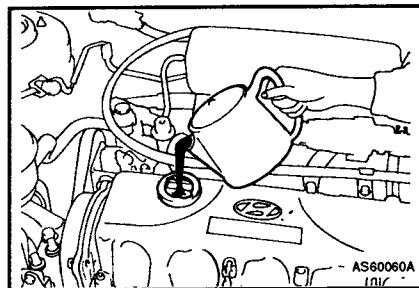
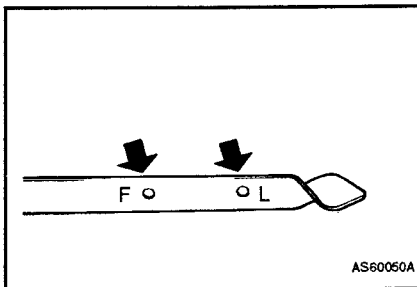
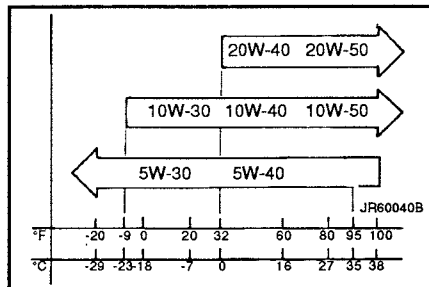

DO-IT-YOURSELF MAINTENANCE

ZG040A1-A

CHANGING THE OIL AND FILTER

The engine oil and filter should be changed at those intervals specified in the maintenance schedule in Section 5. If the car is being driven in severe conditions, more frequent oil and filter changes are required.

The procedure for changing the oil and filter is as follows:

1. Park the car on level ground and set the parking brake. Start the engine and let it warm up until the needle on the temperature gauge moves above the lowest mark. Turn the engine off and place the gear selector lever in "P" (automatic) or reverse gear (manual transaxle).
2. Open the hood and remove the engine oil filler cap.
3. Slide underneath the car and loosen the drain plug by turning it counterclockwise with a

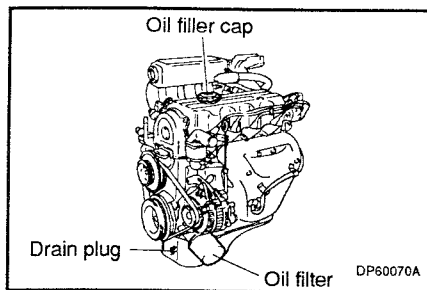

wrench of the proper size. Be sure that a drain pan is in position to catch the oil as it drains out, then remove the drain plug.

WARNING

Be very careful when draining the engine oil as it may be hot enough to burn you!

4. When the oil has stopped draining, replace the drain plug using a new washer and re-tighten by turning it clockwise.
5. Remove the oil filter. You should be able to unscrew the filter with your hands. (If your hands are slippery, try using a cloth between your hands and the filter to give yourself a better grip.) A certain amount of oil will come out when you remove the filter so be sure to have your drain pan in place underneath it.
6. Install a new oil filter in accordance with the instructions on the carton or on the filter itself. Do not over-tighten. Be sure that the mounting surface on the engine is clean and that the old gasket is removed completely. Lubricate the new gasket on the filter before installation with clean engine oil.
7. Refill the crankcase with the recommended engine oil. Refer to the specification in chapter 9 for engine oil capacity.
8. Start the engine and check to be sure no oil is leaking from the drain plug or oil filter.

9. Shut off the engine and recheck the oil level.

NOTE:

Always dispose of used engine oil in an environmentally acceptable manner. It is suggested that it be placed in a sealed container and taken to a service station for reclamation. Do not pour the oil on the ground or put it into the household trash.

WARNING

Used motor oil may cause irritation or cancer of the skin if left in contact with the skin for prolonged periods of time. Wash your hands thoroughly with soap and warm water as soon as possible after handling used oil.

DO-IT-YOURSELF MAINTENANCE

AG050A1-A

CHECKING AND CHANGING THE ENGINE COOLANT

WARNING

Do not remove the radiator cap when the engine is hot. When the engine is hot, the engine coolant is under pressure and may erupt through the opening if the cap is removed. You could be seriously burned if you do not observe this precaution. Do not remove the radiator cap until the radiator is cool to the touch.

AG050B1-A

Recommended Engine Coolant

Use a high quality ethylene-glycol coolant in a 50/50 mix with water. The engine coolant should be compatible with aluminum engine parts. Additional corrosion inhibitors or additives should not be used. The cooling system must be maintained with the correct concentration and type of engine coolant to prevent freezing and corrosion.

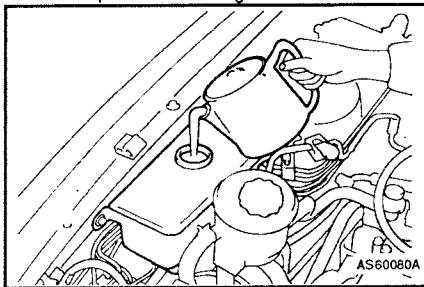

NEVER allow the concentration of antifreeze to exceed the 60% level or go below the 35% level or damage to the cooling system may result. For proper concentration when adding or replacing the engine coolant, refer to the following table.

| Ambient temperature °C (°F) | Engine coolant concentration | |
|---------------------------------|------------------------------|-------|
| | Antifreeze solution | Water |
| -15 (5) | 35% | 65% |
| -25 (-13) | 40% | 60% |
| -35 (-31) | 50% | 50% |
| -45 (-49) | 60% | 40% |

AG050C1-A

To Check the Engine Coolant Level

The engine coolant level can be seen on the side of the plastic engine coolant reservoir. The level of the engine coolant should be between the

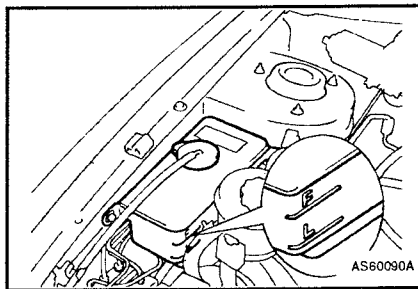

"LOW" and "FULL" lines on the reservoir. If the level is below the "LOW" mark, add engine coolant to bring it up between "LOW" and "FULL". If the level is low, inspect for engine coolant leaks and recheck the fluid level frequently. If the level drops again, visit your Hyundai dealer for an inspection and diagnosis of the reason.

AG050D2-A

To Change the Engine Coolant

The engine coolant should be changed at those intervals specified in the vehicle maintenance schedule in Section 5.

CAUTION:

Engine coolant can damage the finish of your car. If you spill engine coolant on the car, wash it off thoroughly with clean water.

1. Park the car on level ground, set the parking brake and remove the radiator cap when cool.
2. Be sure your drain receptacle is in place. Open the drain cock on the radiator. Allow all the engine coolant to drain from the cooling system, then securely close the drain cock.
3. Check Section 9 for the capacity of the cooling system in your car. Then, following the manufacturer's directions on the engine coolant container, add the appropriate quantity of engine coolant to the radiator. Now fill the radiator with clean water. Continue to add water in small quantities until the fluid level stays up in the radiator neck.

DO-IT-YOURSELF MAINTENANCE

4. Start the engine, top off the radiator with water and then add engine coolant to the reservoir until the level is between "LOW" and "FULL".
5. Replace the radiator and reservoir caps and check to be sure the drain cocks are fully closed and not leaking.

WARNING

The radiator fan is controlled by engine coolant temperature and may sometimes operate even when the engine is not running. Use extreme caution when working near the blades of the cooling fan so that you are not injured by a rotating fan blade. As the engine coolant temperature decreases, the fan will automatically shut off. This is a normal condition.

AG060A1-A

REPLACING THE SPARK PLUGS

The spark plugs should be changed at the intervals specified in the vehicle maintenance schedule in section 5, or whenever engine performance indicates they should be changed. Symptoms that suggest poor spark plug performance include engine misfiring under load, loss of fuel economy, poor acceleration, etc. When spark plugs are replaced, always use spark plugs recommended by Hyundai. The use of other spark plugs can result in loss of performance, radio interference or engine damage.

Recommended Spark Plugs:

CHAMPION : RC9YC4

RC10YC4

NGK : BKR5ES-11

ZG060B2-A

Changing the Spark Plugs

You will find it easier to change spark plugs if the engine is cold.

Always change one spark plug at a time. This helps avoid getting the wires mixed up.

1. Remove the rocker cover. (DOHC only)
2. Using a clean cloth, remove any dirt that has accumulated around the base of the spark plug so it cannot fall into the cylinder when the spark plug is removed.
3. To remove the spark plug cable, pull straight up on the insulated connector, not the cable. Pulling on the cable may damage the carbon core conductor.

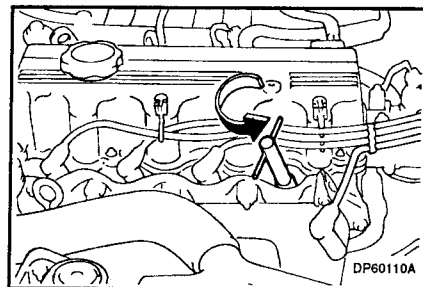
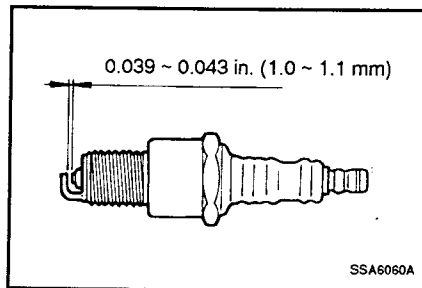

DO-IT-YOURSELF MAINTENANCE

WARNING

It is recommended that the engine be cool or cold when changing the spark plugs. If the engine is hot, you could burn yourself on the insulated connector, the spark plug or the engine itself.

4. When preparing to remove the old spark plug, guide the socket down over the spark plug, being careful not to damage the ceramic insulator.
5. To remove the spark plug, turn the wrench handle in a counterclockwise direction.
6. To replace the new spark plug, guide the socket down over the spark plug, being careful not to damage the ceramic insulator.

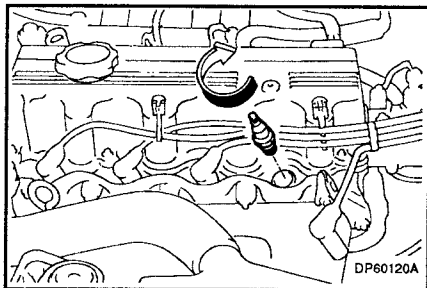

NOTE:

Spark plugs should be tightened firmly. Overtightening can damage the threads in the aluminum cylinder head. Also, leaving them too loose can cause the spark plug to get very hot and possibly result in damage to the engine.

7. Replace the cable by pushing the insulated connector directly down onto the electrode. Check to be sure it has snapped into place and can't fall off.

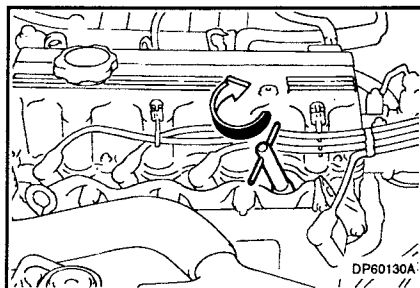

AG070A1-A

CHANGING THE AIR CLEANER FILTER

To change the filter, loosen the bolts (1) around the cover. When this is done, the cover can be lifted off, the old filter removed and the new filter put in its place. Genuine Hyundai replacement parts are recommended.

CAUTION:

Operating your vehicle without a proper air filter in place can result in excessive engine wear.

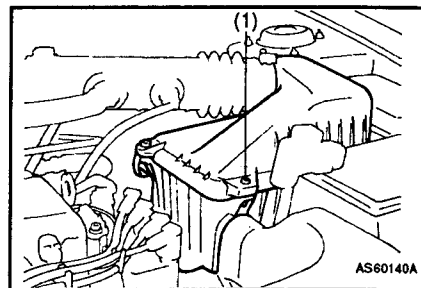

DO-IT-YOURSELF MAINTENANCE

AG080A1-A

WINDSHIELD WIPER BLADES

The wiper blades should be carefully inspected from time to time and cleaned to remove accumulations of road film or other debris. To clean the wiper blades and arms, use a clean sponge or cloth with a mild soap or detergent and water. If the wipers continue to streak or smear the glass, replace them with genuine Hyundai replacement parts or their equivalent.

CAUTION:

Do not operate the wipers on dry glass. This can result in more rapid wear of the wiper blades and may scratch the glass.

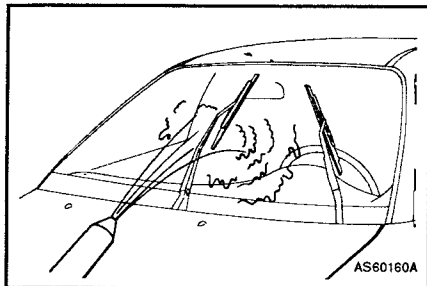

AG090A1-A

FILLING THE WASHER RESERVOIR

The washer fluid reservoir supplies fluid to the windshield washer system.

A good quality washer fluid should be used to fill the washer reservoir. The fluid level should be checked more frequently during bad weather or whenever the washer system is in more frequent use.

The capacity of the washer reservoir is 3.1 U.S. quarts (3.0 Liters).

CAUTION:

- o Radiator antifreeze (engine coolant) should not be used in the washer system because it will damage the car's finish.
- o The washer lever should not be pulled and the washer should not be operated if the washer reservoir is empty. This can damage the washer fluid pump.

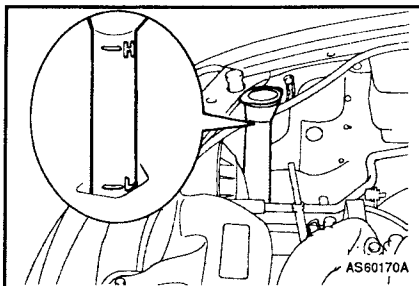

AG100A1-A

CHECKING THE TRANSAXLE OIL (MANUAL)

Transaxle lubricant in the manual transaxle should be checked at those intervals specified in the vehicle maintenance schedule in Section 5.

Recommended Oil

Use only API GL-4 or GL-5 SAE 75W-85W in the manual transaxle.

Manual Transaxle Oil Capacity

The oil capacity of the manual transaxle is 2.27 U.S. quarts (2.15 liters).

WARNING

It is always better to check the transaxle oil level when the engine is cool or cold. If the engine is hot, you should exercise great caution to avoid burning yourself on hot engine or exhaust parts.

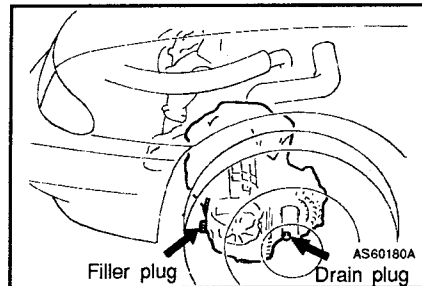

DO-IT-YOURSELF MAINTENANCE

ZG100B1-A

To Check the Transaxle Fluid Level

Park the car on level ground with the engine off.

1. Using a wrench of the correct size, loosen the oil filler plug by turning it counterclockwise and remove it with your fingers.
2. Use your finger to feel inside the hole. The oil level should be at its bottom edge. If it is not, check for leaks before adding oil. To refill the transaxle or bring the oil level up, add oil slowly until it reaches the proper level. Do not overfill.
3. Replace the plug, screw it in with your fingers and then tighten securely with the wrench.

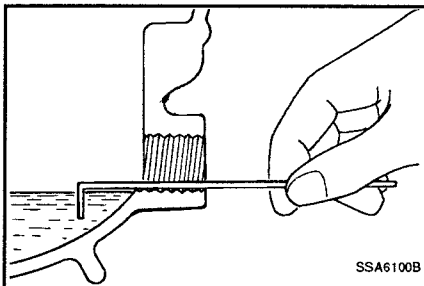

ZG110A1-A

CHECKING THE TRANSAXLE FLUID (AUTOMATIC)

Transaxle fluid in the automatic transaxle should be changed at those intervals specified in the vehicle maintenance schedule in Section 5.

ZG110B3-A

Recommended Fluid

Your Hyundai automatic transaxle is specially designed to operate with GENUINE HYUNDAI AUTOMATIC TRANSMISSION FLUID, MOPAR ATF PLUS TYPE 7176, DIAMOND ATF SP or other equivalent transmission fluid.

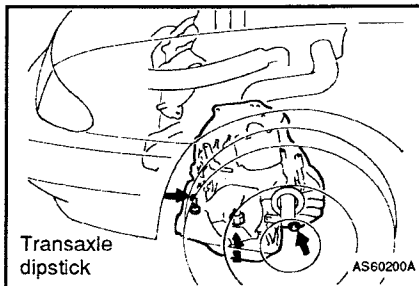

DO-IT-YOURSELF MAINTENANCE

AG110C1-A

Transaxle Fluid Capacity

The fluid capacity of the automatic transaxle is 7.08 U.S. quarts (6.7 liters).

WARNING

The transaxle fluid level should be checked when the engine is at normal operating temperature. This means that the engine, radiator, exhaust system etc., are very hot. Exercise great care not to burn yourself during this procedure.

AG110D1-A

To Check the Transaxle Fluid Level

Park the car on level ground with the parking brake engaged. When the transaxle fluid level is checked, the transaxle fluid should be at normal operating temperature and the engine idling.

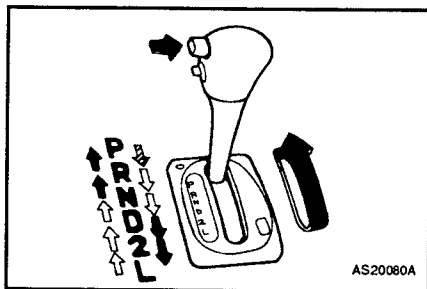

While the engine is idling, apply the brakes and move the gear selector lever from "P" to each of its other positions — "R", "N", "D", "2", "L" — and then return to "N". With the engine still idling:

1. Open the hood, being careful to keep hands, long hair and clothing clear of any moving parts.
2. Remove the transaxle dipstick, wipe it clean, reinsert the dipstick as far as it will go, then remove it again. Now check the fluid level on the dipstick. It should be in the "HOT" range on the dipstick.
3. If the transaxle fluid level is low, use a funnel to add transaxle fluid through the dipstick tube until the level reaches the "HOT" range. Do not overfill.

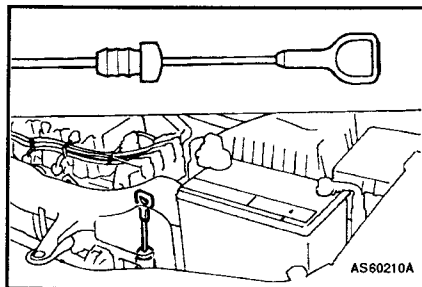

WARNING

The radiator fan is controlled by engine coolant temperature and may sometimes operate even when the engine is not running. Use extreme caution when working near the blades of the cooling fan, so that you are not injured by a rotating fan blade. As the engine coolant temperature decreases, the fan will automatically shut off. This is a normal condition.

ZG120A1-A

CHECKING THE BRAKES

CAUTION:

Because brakes are essential to the safe operation of the car, it is suggested that they be checked and inspected by your Hyundai dealer. The brakes should be checked and inspected for wear at those intervals specified in the vehicle maintenance schedule in Section 5.

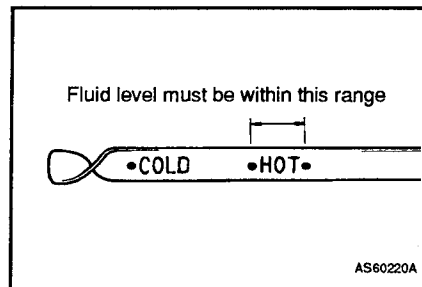

DO-IT-YOURSELF MAINTENANCE

ZG120B1-A

Checking the Brake Fluid Level

WARNING

Use caution when handling brake fluid. It can damage your vision if it gets into your eyes. It will also damage your vehicle's paint if spilled on it and not removed immediately.

ZG120C1-A

Recommended Brake Fluid

Use only hydraulic brake fluid conforming to DOT 3 specifications in your braking system. Follow the instructions printed on the container.

ZG120D1-A

To Check the Fluid Level

The fluid level in the brake fluid reservoir should be checked periodically. The level should be between the "MIN" and "MAX" marks on the side of the reservoir. If the level is at or below the "MIN" mark, carefully add fluid to bring it up to "MAX". Do not overfill.

ZG120E1-A

Adding Brake Fluid

WARNING

Handle brake fluid carefully. It can damage your vision if it gets into your eyes. Use only DOT 3 specification fluid from a sealed container. Do not allow the fluid can or reservoir to remain open any longer than required. This will avoid entry of dirt and moisture which can damage the brake system and cause improper operation.

To add brake fluid, first wipe away any dirt then unscrew the fluid reservoir cap. Slowly pour the recommended fluid into the reservoir. Do not over fill. Carefully replace the cap on the reservoir and tighten.

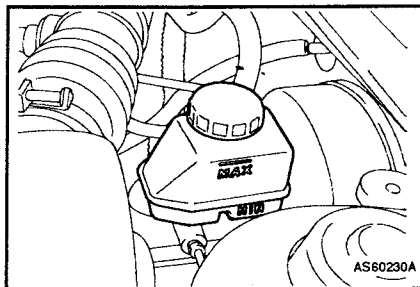

ZG130A1-A

CHECKING THE CLUTCH FLUID

To Check the Clutch Fluid

The clutch fluid level in the master cylinder should be checked when performing other under hood services. The system should be checked for leakage at the same time.

Check to make certain that the clutch fluid level is between the "MAX" and "MIN" level markings on the fluid reservoir. Fill as required. Fluid loss indicates a leak in the clutch system which should be inspected and repaired immediately. Consult your Hyundai dealer.

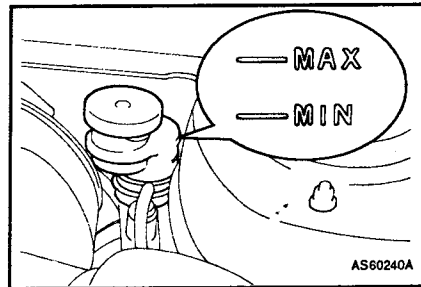

DO-IT-YOURSELF MAINTENANCE

ZG130B1-A

To Replace the Fluid

Recommended brake fluid conforming to DOT 3 specification should be used. The reservoir cap must be fully tightened to avoid contamination from foreign matter or moisture.

NOTE:

Do not allow any other liquids to contaminate the brake fluid. Seal damage will result.

WARNING

Use caution when handling brake fluid. It can damage your vision if you get it in your eyes. It will also damage your vehicle's paint if spilled on it and not removed immediately.

ZG140A1-A

AIR CONDITIONING CARE

Keeping the Condenser Clean

The air conditioning condenser (and engine radiator) should be checked periodically for accumulation of dirt, dead insects, leaves, etc. These can interfere with maximum cooling efficiency. When removing such accumulations, brush or hose them away carefully to avoid bending the cooling fins.

ZG140B1-A

Checking the Compressor Drive Belt

When the air conditioning is being used regularly, the compressor drive belt tension should be checked at least once a month. To check the drive belt tension, press down on the belt halfway between the engine crankshaft and compressor pulleys. Pressing with your finger, you should not be able to deflect this belt anymore than one-half inch. If you have the instruments to check it, with a force of 22 lb. (98N), the deflection should be 0.31-0.39 inches (8-10 mm). If the belt is too loose or too tight, have it adjusted by your Hyundai dealer.

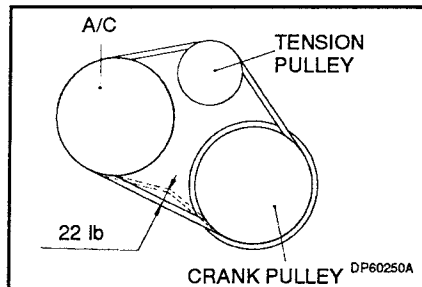

DO-IT-YOURSELF MAINTENANCE

ZG140C1-A

Checking the Air Conditioning Operation

1. Start the engine and let it run at fast idle for several minutes with the air conditioning set at the maximum cold setting.
2. If the air coming out of the in-dash vents is not cold, have the air conditioning system inspected by your Hyundai dealer.

CAUTION:

Running the air conditioning system for extended periods of time with a low refrigerant level may damage the compressor.

ZG140D1-A

Lubrication

To lubricate the compressor and the seals in the system, the air conditioning should be run for at least 10 minutes each week. This is particularly important during cool weather when the air conditioning system is not otherwise in use.

ZG150A1-A

CHECKING STEERING WHEEL FREE-PLAY

To check the steering wheel free-play, stop the car with the wheels pointed straight ahead and gently move the steering wheel back and forth. Use very light finger pressure and be sensitive to changes in resistance that mark the limits of the free-play. If the free-play is greater than specified, have it inspected by your Hyundai dealer and adjusted or repaired if necessary.

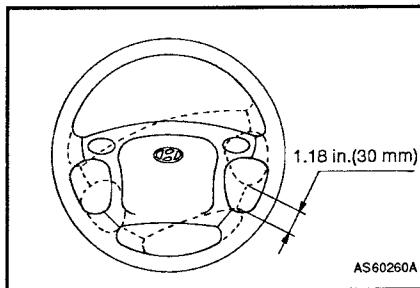

ZG160A1-A

CHECKING CLUTCH PEDAL FREE-PLAY

With the engine off, press lightly on the clutch pedal until you feel a change in resistance. This is the clutch pedal free-play. The free-play should be within the limits specified in the illustration below. If it is not, have it inspected by your Hyundai dealer and adjusted or repaired if necessary.

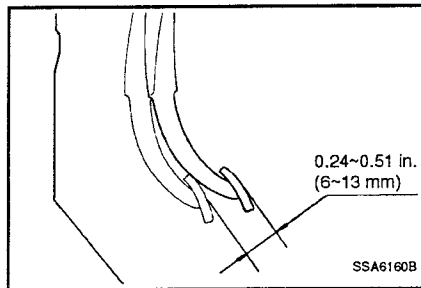

DO-IT-YOURSELF MAINTENANCE

ZG170A1-A

CHECKING BRAKE PEDAL FREE-PLAY

With the engine off, press down on the brake pedal several times to reduce the vacuum in the brake booster.

Then, using your hand, press down slowly on the brake pedal until you feel a change in resistance. This is the brake pedal free-play.

The free-play should be within the limits specified in the illustration below. If it is not, have it inspected by your Hyundai dealer and adjusted or repaired if necessary.

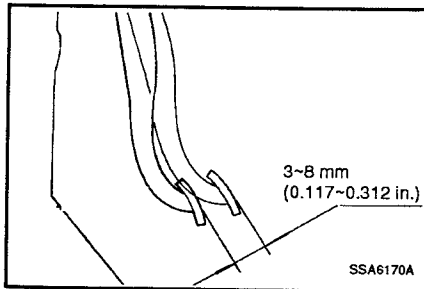

6-16

ZG180A1-A

CHECKING BRAKE PEDAL CLEARANCE

You need a helper to check the brake pedal clearance. With the engine running, have your helper press down on the brake pedal several times and then hold it down with a force of about 110 lbs (50 kg, 490 N). The brake pedal clearance is the distance from the top surface of the brake pedal to the asphalt sheeting under the floor mat.

If the brake pedal clearance is not within the limits specified in the illustration, have it inspected by your Hyundai dealer and adjusted or repaired if necessary.

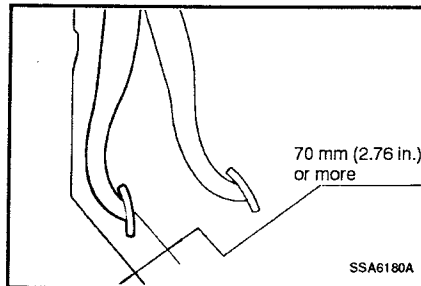

ZG190A1-A

CHECKING DRIVE BELTS

Drive belts should be checked periodically for proper tension and adjusted if necessary. At the same time, belts should be examined for cracks, wear, fraying or other evidence of deterioration and replaced if necessary.

Belt routing should also be checked to be sure there is no interference between the belts and other parts of the engine. After a belt is replaced, the new belt should be adjusted again after two or three weeks to eliminate slack resulting from initial stretching after use.

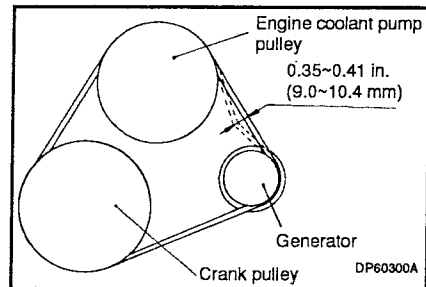

DO-IT-YOURSELF MAINTENANCE

AG200A1-A

CHECKING AND REPLACING FUSES

Replacing a Fusible Link

A fusible link will melt if the electrical circuits from the battery are ever overloaded, thus preventing damage to the entire wiring harness. (This could be caused by a short in the system drawing too much current.) If this ever happens, have a Hyundai dealer determine the cause, repair the system and replace the fusible link. The fusible links are located in a relay box for easy inspection.

CAUTION:

When replacing a fusible link, never use anything but a new fusible link with the same or lower amperage rating. Never use a piece of wire or a higher-rated fusible link. This could result in serious damage and create a fire hazard.

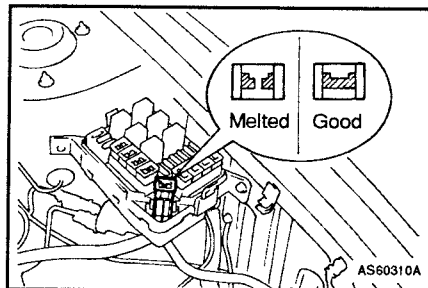

ZG200B1-A

Replacing Accessory Fuse

The fuse box for the lights and other electrical accessories will be found low on the dashboard on the driver's side. Inside the box you will find a list showing the circuits protected by each fuse. If any of your car's lights or other electrical accessories stop working, a blown fuse could be the reason. If the fuse has burned out, you will see that the metal strip inside the fuse has burned through. If you suspect a blown fuse, follow this procedure:

1. Turn off the ignition and all other switches.
2. Open the fuse box and examine each fuse. Remove each fuse by pulling it toward you (a small "fuse puller" tool is contained in the fuse box to simplify this operation).

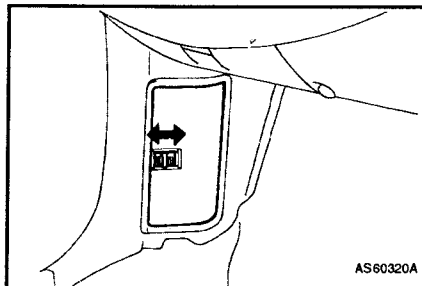

3. Be sure to check all other fuses even if you find one that appears to have burned out.
4. Replace the blown fuse by pressing a new fuse of the same rating into place. The fuse should be a snug fit. If it is not, have the fuse clip repaired or replaced by a Hyundai dealer. If you do not have a spare fuse, you may be able to borrow a fuse of the same or lower rating from an accessory you can temporarily get along without (the radio or cigarette lighter, for example). Always remember to replace the borrowed fuse.

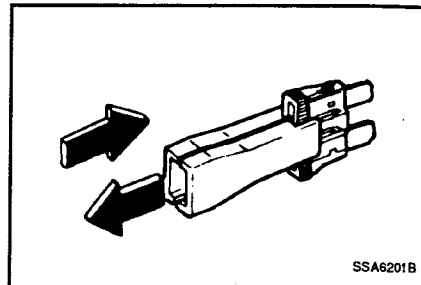

DO-IT-YOURSELF MAINTENANCE

CAUTION:

A burned-out fuse indicates that there is a problem in the electrical circuit. If you replace a fuse and it blows as soon as the accessory is turned on, the problem is serious and should be referred to a Hyundai dealer for diagnosis and repair. Never replace a fuse with anything except a fuse with the same or a lower amperage rating. A higher capacity fuse could cause damage and create a fire hazard.

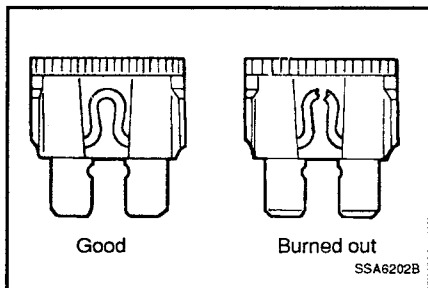

ZG210A1-A

CHECKING THE BATTERY

WARNING

When working with batteries, carefully observe the following precautions to avoid serious injuries.

The fluid in the battery contains a strong solution of sulfuric acid, which is poisonous and highly corrosive. Be careful not to spill it on yourself or the car. If you do spill battery fluid on yourself, immediately do the following:

- o If battery fluid is on your skin, flush the affected areas with water for at least 15 minutes and then seek medical assistance.
- o If battery fluid is in your eyes, rinse out your eyes with water and get medical assistance as soon as possible. While you are being driven to get medical assistance, continue to rinse your eyes by using a sponge or soft cloth saturated with water.
- o If you swallow battery fluid, drink a large quantity of water or milk followed by milk of magnesia, eat a raw egg or drink vegetable oil. Get medical assistance as soon as possible.

While batteries are being charged (either by a battery charger or by the vehicle's alternator), they produce explosive gases. Always observe

these warnings to reduce the risk of injury:

- o Charge batteries only in a well ventilated area.
- o Do not permit flames, sparks or smoking in the area.
- o Keep children away from the area.

ZG210B1-A

Checking the Battery

Keep the battery clean. Any evidence of corrosion around the battery posts or terminals should be removed using a solution of household baking soda and warm water. After the battery terminals are dry, cover them with a light coating of grease.

DO-IT-YOURSELF MAINTENANCE

AG220A2-A

CHECKING ELECTRIC COOLING FANS

WARNING

The radiator fan is controlled by engine coolant temperature and may sometimes operate even when the engine is not running. Use extreme caution when working near the blades of the cooling fan, so that you are not injured by a rotating fan blade. As the engine coolant temperature decreases the fan will automatically shut off. This is a normal condition.

Checking Engine Cooling Fan

The engine cooling fan should come on automatically if the engine coolant temperature is high.

Checking Condenser Cooling Fan

The condenser cooling fan should come on automatically whenever the air conditioning is in operation.

JG230A2-A

POWER STEERING FLUID LEVEL

The power steering fluid level should be checked daily.

To check the power steering fluid level, be sure the ignition is "OFF", then check to make certain that the power steering fluid level is between the "MAX" and "MIN" level markings on the fluid reservoir.

NOTE:

Grinding noise from the power steering pump may be heard immediately after the engine is started in extremely cold conditions (below -20°C). In this case, if the noise stops during warm up, there is no abnormal function in the system. This is due to a power steering fluid characteristic in extremely cold conditions.

Recommended Fluid

Use ATF Dexron II type fluid.

NOTE:

Do not start the engine when the power steering oil reservoir is empty.

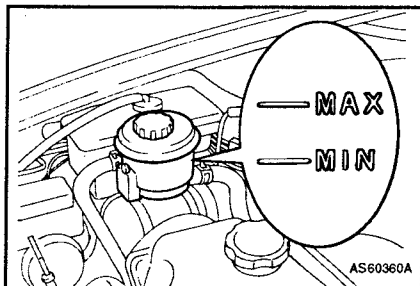

DO-IT-YOURSELF MAINTENANCE

ZG230B1-A

POWER STEERING HOSES

It is suggested that you check the power steering hose connections for fluid leakage daily. The power steering hoses should be replaced if there is severe surface cracking, pulling, scuffing or worn spots. Deterioration of the hoses could cause premature failure.

ZG240A1-A

FOR MORE INFORMATION ABOUT YOUR HYUNDAI

If you desire additional information about maintaining and servicing your Hyundai, you may purchase a factory Shop Manual at your Hyundai dealer's parts department. This is the same manual used by dealership technicians and while it is highly technical it can be useful in obtaining a better understanding of your car and how it works.

ZG250A1-A

REPLACING LIGHT BULBS

Before attempting to replace a light bulb, be sure the switch is turned to the "OFF" position. The drawings on the next pages show how to reach light bulbs so they may be changed. Be sure to replace the burned-out bulb with one of the same number and wattage rating.

ZG260A1-A

HEADLIGHT

REPLACEMENT INSTRUCTIONS:

1. Allow the bulb to cool. Wear eye protection.
2. Always grasp the bulb by its plastic base, avoid touching the glass.
3. Unscrew the locking collar securing the bulb.
4. Disconnect the power cord from the bulb base in the back of the headlight and remove the used bulb from the headlight.

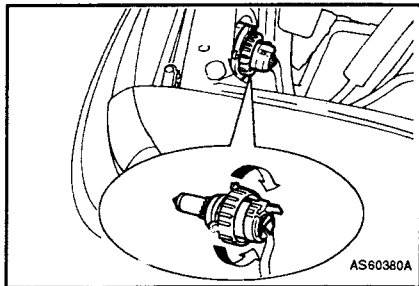

DO-IT-YOURSELF MAINTENANCE

5. Remove the protective cap from the replacement bulb and install the new bulb by matching the plastic base with the headlight hole. Reconnect the power cord and re-tighten the locking collar.
6. Use the protective cap and carton to promptly dispose of the old bulb.
7. Check for proper headlight aim.

WARNING

This halogen bulb contains gas under pressure and if impacted could shatter, resulting in flying fragments. Always wear eye protection when servicing the bulb. Protect the bulb against abrasions or scratches and against liquids when lighted. Turn on the bulb only when installing in a headlight. Replace the headlight if damaged or cracked. Keep the bulb out of the reach of children and dispose of the used bulb with care.

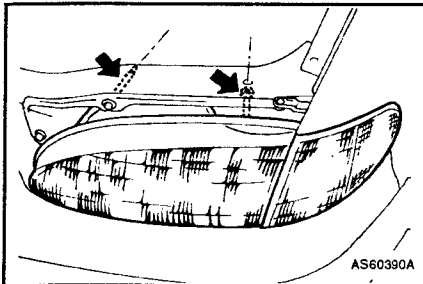

DO-IT-YOURSELF MAINTENANCE

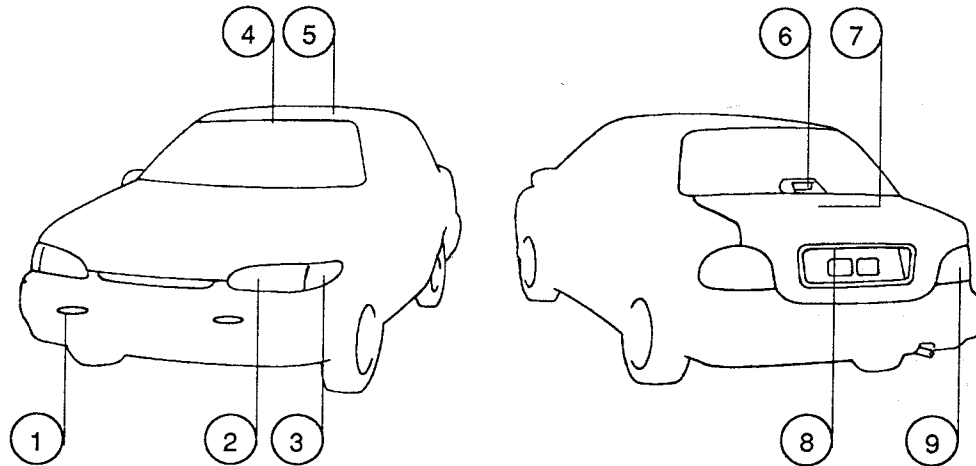

AS60400A

| No. | Part Name | Wattage | No. | Part Name | Wattage | |
|-----|--------------------------------|---------|-----|---------------------------|---------|------|
| 1 | Front Fog Light (If installed) | 55 | 7 | Luggage Compartment Light | 5 | |
| 2 | Headlight | 65/45 | 8 | License Plate Light | 5 | |
| 3 | Front Turn Signal Light | 28/8 | 9 | Rear Combination Light | 27 | |
| 4 | Interior Light/Map Light | 10/8 | | Turn Signal Light | | |
| 5 | Interior Light | 10 | | Stop/Tail Light | | 27/8 |
| 6 | High Mounted Rear Stop Light | 27 | | Back-up Light | | 27 |

ZH000A1-A

7. EMISSION CONTROL SYSTEMS

EMISSION CONTROL SYSTEMS

ZH010A1-A

EMISSION CONTROL SYSTEM

Your Hyundai is equipped with an emission control system to meet all requirements of the U.S. Environmental Protection Agency or California Air Resources Board.

There are three emission control systems which are as follows.

- (1) Crankcase emission control system
- (2) Evaporative emission control system
- (3) Exhaust emission control system

In order to assure the proper function of the emission control systems, it is recommended that you have your car inspected and maintained by an authorized Hyundai dealer in accordance with the maintenance schedule in this manual.

ZH010B1-A

1. CRANKCASE EMISSION CONTROL SYSTEM

The positive crankcase ventilation system is employed to prevent air pollution caused by blow-by gases being emitted from the crankcase. This system supplies fresh filtered air to the crankcase through the air cleaner. Inside the crankcase, the fresh air mixes with blow-by gases, then passes through the PCV valve and into the intake of the engine.

ZH010C1-A

2. EVAPORATIVE EMISSION CONTROL SYSTEM

The Evaporative Emission Control System is designed to prevent fuel vapors from escaping into the atmosphere.

Evaporative Emission Canister

While the engine is inoperative, fuel vapors generated inside the fuel tank are absorbed and stored in the canister. When the engine is running, the fuel vapors absorbed in the canister are drawn into the induction system through the evaporative emission canister purge control solenoid valve.

Evaporative Emission Canister Purge Control Solenoid Valve

The evaporative emission canister purge control solenoid valve is controlled by the ECM; when the engine coolant temperature is low, and during idling, it closes, so that evaporated fuel is not taken into the intake system. After engine warm-up, during ordinary driving, it opens so as to introduce evaporated fuel to the intake system.

DH010D2-A

3. EXHAUST EMISSION CONTROL SYSTEM

The Exhaust Emission Control System is a highly effective system which controls exhaust emissions while maintaining good vehicle performance.

EMISSION CONTROL SYSTEMS

ZH020A2-A

CATALYTIC CONVERTER

All Hyundai vehicles are equipped with a monolith type three-way catalytic converter to reduce the carbon monoxide, hydrocarbons and nitrogen oxides contained in the exhaust gas. Exhaust gases passing through the catalytic converter may cause it to operate at a very high temperature. The introduction of large amounts of unburned gasoline into the exhaust may cause the catalytic converter to overheat and create a fire hazard. This risk may be reduced by observing the following:

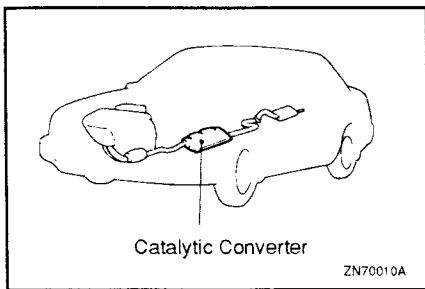

WARNING

- o Use unleaded fuel only.
 - o Maintain the engine in good operating condition. Extremely high converter temperatures can result from improper operation of the electrical, ignition or Multiport Fuel Injection System.
 - o If your engine stalls, pings, knocks, or is hard to start, have your Hyundai dealer inspect and repair the problem as soon as possible.
 - o Avoid driving with a very low fuel level. Running out of gasoline may cause the engine to misfire and result in damage to the catalytic converter.
 - o Avoid idling the engine for periods longer than 10 minutes.
 - o The vehicle should not be pushed or pulled to get started. This may cause the catalytic converter to overheat and create a fire hazard.
 - o Do not touch the catalytic converter or any other part of the exhaust system while the catalytic converter is hot. Shut off the engine and wait for at least one hour before touching the catalytic converter or any other part of the exhaust system.
 - o Remember that your Hyundai dealer is your best source of assistance.
- o Do not stop your Hyundai over any combustible material such as grass, paper, leaves, or rags. These materials might contact the hot catalytic converter and a fire might result.

Z1000A1-A

8. THINGS YOU SHOULD KNOW

**Consumer Information
Reporting Safety Defects**

CONSUMER INFORMATION

Z1010A1-A

VEHICLE IDENTIFICATION NUMBER (VIN)

The vehicle identification number (VIN) is the number used in registering your car and in all legal matters pertaining to its ownership, etc. It can be found in three different places on your car:

1. On the left top side of the instrument panel where it can be seen by looking down through the windshield.
2. On the firewall between the engine and passenger compartments.
3. On the lower side of the left front door pillar.

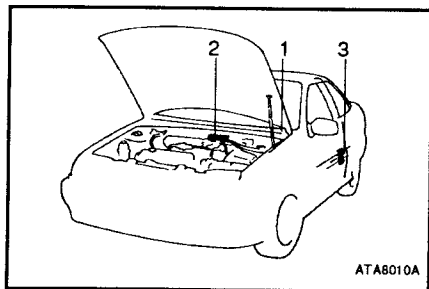

Z1010B1-A

Engine Number

The engine number is stamped on the engine block as shown in the drawing.

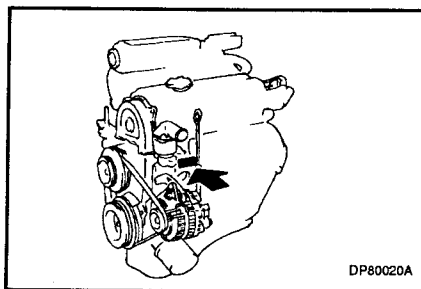

Z1010C1-A

TIRE INFORMATION

The tires supplied on your new Hyundai are chosen to provide the best performance for normal driving.

AI020A1-A

RECOMMENDED INFLATION PRESSURES

The tire label located in the glove box gives the tire pressures recommended for your car. These pressures were chosen to provide the most satisfactory combination of ride comfort, tire wear and stability under normal conditions.

Tire pressures should be checked at least monthly. Proper tire inflation pressures should be maintained for these reasons:

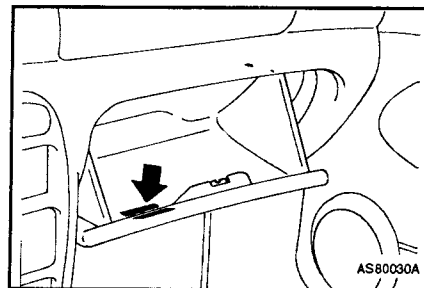

CONSUMER INFORMATION

- o Lower-than-recommended tire pressures cause uneven tread wear and poor handling.
- o Higher-than-recommended tire pressures increase the chance of damage from impacts and cause uneven tread wear.

CAUTION:

Always observe the following:

- o **Check pressures when the tires are cold. That is, after the car has been parked for at least three hours and hasn't been driven more than one mile or 1.6 km since starting up.**
- o **Check the pressure of your spare tire each time you check the pressure of other tires.**
- o **Never overload your car. Be especially careful about overloading if you equip your car with a luggage rack or car top carrier.**

Z1030A1-A

SNOW TIRES

If you equip your car with snow tires, they should be the same size and have the same load capacity as the original tires. Snow tires should be installed on all four wheels; otherwise, poor handling may result.

Snow tires should carry 4 psi (28 kPa) more air pressure than the pressure recommended for the standard tires on the tire label on the glove box, or up to the maximum pressure shown on the tire sidewall whichever is less.

Do not drive faster than the speed limit when your car is equipped with snow tires.

A1040A2-A

TIRE CHAINS

WARNING

Tire chains should not be used on P175/65R14. With these tires there is not sufficient clearance for chains between the tires and other vehicle components and damage may result.

Tire chains should be installed on the front wheels. Be sure that the chains are the proper size and that they are installed in accordance with the manufacturer's instructions.

To minimize tire and chain wear, do not continue to use tire chains when they are no longer needed.

WARNING

When driving on roads covered with snow or ice, drive at less than 20 mph (30 km/h).

CONSUMER INFORMATION

AI050A1-A

TIRE ROTATION

Tires should be rotated every 6,000 miles (10,000 km). If you notice that tires are wearing unevenly between rotations, have the car checked by a Hyundai dealer so the cause may be corrected. After rotating, adjust the tire pressures and be sure to check wheel nut tightness.

WARNING

- o Do not use the temporary spare tire for tire rotation.
- o Do not mix bias-ply and radial-ply tires under any circumstances. This may affect control of the vehicle, resulting in serious injury or death.

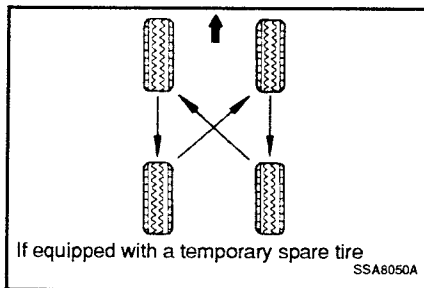

ZI060A1-A

TIRE BALANCING

A tire that is out of balance may affect handling and tire wear. The tires on your Hyundai were balanced before the car was delivered but may need balancing again during the years you own the car.

Whenever a tire is dismantled for repair, it should be re-balanced before being reinstalled on the car.

ZI060B1-A

TIRE TRACTION

Tire traction can be reduced if you drive on worn tires, tires that are improperly inflated or on slippery road surfaces. Tires should be replaced when tread wear indicators appear. To reduce the possibility of losing control, slow down whenever there is rain, snow or ice on the road.

AI060C1-A

WHEN TO REPLACE TIRES

WARNING

Driving on worn-out tires is dangerous! Worn-out tires can cause loss of braking effectiveness, steering control and traction. When replacing tires, never mix radial and bias-ply tires on the same car. If you replace radial tires with bias-ply tires, they must be installed in sets of four.

The original tires on your car have tread wear indicators. The tread wear indicators appear when the tread depth is 0.06 in. (1.6 mm). The tire should be replaced when these appear as a solid bar across two or more grooves of the tread. Always replace your tires with those of the recommended size. If you change wheels, the new wheel's rim width and offset must meet Hyundai specializations.

WARNING

Using tires and wheels of other than the recommended sizes may affect control of the vehicle resulting in serious injury or death.

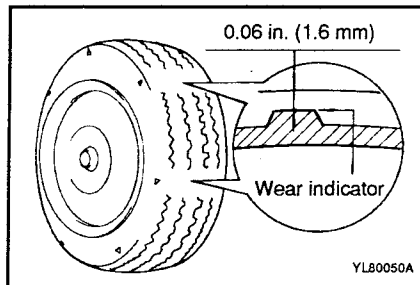

CONSUMER INFORMATION

ZI070A2-A

SPARE TIRE AND TOOLS

Your Hyundai is delivered with the following:

Spare tire and wheel
Wrench
Jack
Jack handle

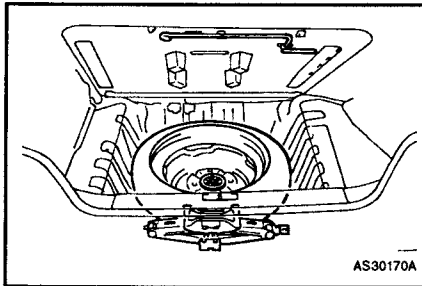

ZI080A1-A

SHOP MANUAL

A Hyundai Shop Manual is available from your authorized Hyundai dealer. It's written for the professional technicians, but is simple enough for most mechanically-inclined owners to understand.

AA010A1-A

WARRANTIES FOR YOUR HYUNDAI VEHICLE

- o New Vehicle 36 months/36,000 Mile Limited Warranty
- o New Vehicle 60 months/60,000 Mile Limited Powertrain Warranty
- o Anti-Perforation Limited Warranty
- o Emission Defect Warranty - Federal Vehicle
- o California Emission Control System Warranty (if applicable)
- o Emission Performance Warranty - Federal vehicle
- o Replacement Parts and Accessories Limited Warranty

NOTE

Detailed warranty information is provided in your Hyundai Owner's Handbook.

ZI090A1-A

CONSUMER INFORMATION

This consumer information has been prepared in accordance with regulations issued by the National Highway Traffic Safety Administration of the U.S. Department of Transportation. It provides the purchasers and/or prospective purchasers of Hyundai automobiles with information on uniform tire quality grading. Your Hyundai dealer will help answer any questions you may have as you read this information.

CONSUMER INFORMATION

Z1100A1-A

Uniform tire quality grading

Department of Transportation quality grades
- All passenger vehicle tires must conform to Federal Safety Requirements in addition to these grades. These quality grades are molded on the sidewall.

Treadwear - The treadwear grade is a comparative rating based on the wear rate of the tire when tested under controlled conditions on a specified government test course. For example, a tire graded 150 would wear one and a half (1 - 1/2) times as well on the government course as a tire graded 100. The relative performance of tires depends upon the actual conditions of their use, however, and may depart significantly from the norm due to variations in driving habits, service practices and differences in road characteristics and climate.

Traction A, B, C - The traction grades, from highest to lowest, are A, B, and C, and they represent the tire's ability to stop on wet pavement as measured under controlled conditions on specified government test surfaces of asphalt and concrete. A tire marked C may have poor traction performance.

WARNING

The traction grade assigned to this tire is based on braking (straight ahead) traction tests and does not include cornering (turning) traction.

Temperature A, B, C - The temperature grades are A (the highest), B, and C, representing the tire's resistance to the generation of heat and its ability to dissipate heat when tested under controlled conditions on a specified indoor laboratory test wheel. Sustained high temperature can cause the material of the tire to degenerate and reduce tire life, and excessive temperature can lead to sudden tire failure. The grade C corresponds to a level of performance which all passenger car tires must meet under the Federal Motor Vehicle Safety Standard No. 109. Grades B and A represent higher levels of performance on the laboratory test wheel than the minimum required by law.

WARNING

The temperature grade for this tire is established for a tire that is properly inflated and not overloaded. Excessive speed, under inflation, or excessive loading, either separately or in combination, can cause heat buildup and possible tire failure which may result in death, serious injury, or property damage.

REPORTING SAFETY DEFECTS

Z110B1-A

Hyundai Motor vehicles are designed and manufactured to meet or exceed all applicable safety standards.

For your safety, however, we strongly urge you to read and follow all directions in this Owner's Manual, particularly the information under the headings "**NOTE**", "**CAUTION**" and "**WARNING**".

If, after reading this manual, you have any questions regarding the operation of your vehicle, please contact your nearest Hyundai Motor America Regional Office as listed below:

Eastern Region: Connecticut, Delaware, Maine, Maryland, Massachusetts, New Hampshire, New Jersey, New York, Pennsylvania, Rhode Island, Vermont, Virginia, West Virginia.

Eastern Region
1100 Cranbury South River Road
Jamesburg, NJ 08831
(800) 633-5151

Southern Region: Alabama, Arkansas, Florida, Georgia, Louisiana, Mississippi, North Carolina, South Carolina, Oklahoma, Tennessee, Texas.

Southern Region
240 North Thornton Road
Lithia Springs, GA 30057
(800) 633-5151

Central Region: Illinois, Indiana, Missouri, Iowa, Kansas, Kentucky, Michigan, Minnesota, Nebraska, North Dakota, South Dakota, Ohio, Wisconsin.

Central Region
700 No. Enterprise Street
Aurora, Illinois 60504
(800) 633-5151

Western Region: Alaska, Hawaii, Arizona, California, Colorado, Idaho, Montana, Nevada, New Mexico, Oregon, Texas, Utah, Washington, Wyoming.

Western Region
10550 Talbert Avenue
P. O. Box 20850
Fountain Valley, California 92728-0850
(800) 633-5151

Z110A1-A

Reporting Safety Defects

If you believe that your vehicle has a defect which could cause a crash or could cause injury or death, you should immediately inform the National Highway Traffic Safety Administration (NHTSA) in addition to notifying HYUNDAI MOTOR AMERICA. If NHTSA receives similar complaints, it may open an investigation, and if it finds that a safety defect exists in a group of vehicles, it may order a recall and remedy campaign. However, NHTSA cannot become involved in individual problems between you, your dealer, or HYUNDAI MOTOR AMERICA.

REPORTING SAFETY DEFECTS

To contact NHTSA, you may either call the Auto Safety Hotline toll-free at 1-800-424-9393 (or 366-0123 in Washington, D.C. area) or write to: NHTSA, U.S. Department of Transportation, Washington, D.C. 20590. You can also obtain other information about motor vehicle safety from the Hotline.

ZJ000A1-A

9. VEHICLE SPECIFICATIONS

VEHICLE SPECIFICATIONS

MEASUREMENT

| | 4 DR | 3 DR |
|--------------------------|---------------------|--------------------|
| Overall length | 162.1 in. (4117 mm) | 161.5 in (4103 mm) |
| Overall width | 63.8 in. (1620 mm) | 63.8 in (1620 mm) |
| Overall height (unladen) | 54.9 in. (1394 mm) | 54.9 in. (1394 mm) |
| Wheel base | 94.5 in. (2400 mm) | 94.5 in. (2400 mm) |
| Wheel tread | Front | 55.9 in. (1420 mm) |
| | Rear | 55.5 in. (1410 mm) |

POWER STEERING

| | |
|-----------------|--------------------------|
| Type | Rack and pinion |
| Wheel free play | 0 ~ 1.18 in. (0 ~ 30 mm) |
| Rack stroke | 5.3 in. (134 mm) |
| Oil pump type | Vane type |

TIRE

| | |
|----------|---------------|
| Standard | P 155/80 R 13 |
| Option | P 175/70 R 13 |
| | P 175/65 R 14 |
| Spare | T 105/70 D 14 |

ELECTRICAL

| | | |
|-----------|-------------|--------|
| Battery | MF 12V 55AH | |
| Generator | 13.5V 75A | |
| Starter | Auto T/A | 0.9 KW |
| | Manual T/A | 0.7 KW |

BRAKE

| | |
|------------------|-----------------------------------|
| Type | Dual hydraulic with brake booster |
| Front brake type | Ventilated disc |
| Rear brake type | Drum (With ABS) |
| | Drum (Without ABS) |
| Parking brake | Cable operated on rear wheel |

FUEL SYSTEM

| | US.gal | Imp.gal | Liter |
|--------------------|--------|---------|-------|
| Fuel tank Capacity | 11.9 | 9.9 | 45 |

VEHICLE SPECIFICATIONS

ENGINE

| ITEMS | Specifications | |
|-------------------------------|------------------------------------|-----------------|
| Engine type | 4-Cylinder in-line OHC | |
| Idle speed (RPM) | 800 ± 100 | |
| Spark plug | NGK | BKR5ES-11 |
| | CHAMPION | RC9YC4, RC10YC4 |
| Spark plug gap | 0.039 to 0.043 in. (1.0 to 1.1 mm) | |
| Valve Clearance (Warm engine) | Intake v/v | Auto lash |
| | Exhaust v/v | Auto lash |
| Ignition Timing | BTDC 9° ± 5° | |
| Firing order | 1-3-4-2 | |

VEHICLE SPECIFICATIONS

LUBRICATION CHART

| Item | | Oil & Coolant Standard | Q'ty |
|----------------|--------------------------|---|---|
| Engine Oil | API SH SG or SG/CD | SAE 20W-40, 20W-50 (ABOVE 32°F OR 0°C) | Drain and refill W/O oil filter (2.9 us.qts, 2.3 Imp.qts, 3.0 liter) W oil filter (3.49 us.qts, 2.9 Imp.qts, 3.3 liter) |
| | | SAE 10W-30, 10W-40, 10W-50 (ABOVE -10°F OR -23°C) | |
| | | SAE 5W-30, 5W-40 (BELOW 100°F OR 38°C) | |
| Transaxle | Manual | API GL-4 or GL-5 SAE 75W/85W | (2.27 us.qts, 1.9 Imp.qts, 2.15 liter) |
| | Auto | GENUINE HYUNDAI ATF AUTOMATIC TRANSMISSION FLUID OR MOPAR ATF PLUS TYPE 7176, DIAMOND ATF SP | (7.08 us.qts, 5.9 Imp.qts, 6.7 liter) |
| Power steering | | ATF Dexron II Type | (0.95 us.qts, 0.79 Imp.qts, 0.9 liter) |
| Brake fluid | | DOT 3 or equivalent | As required |
| Engine coolant | | Ethylene glycol base for aluminum radiator | (5.7 us.qts, 5.1 Imp.qts, 5.5 liter) |

ZK000A1-A

10. INDEX

INDEX

A

| | |
|-------------------------------|-------------|
| Air bag | 1-15 ~ 1-18 |
| Air conditioning | |
| - care | 6-14 |
| - operation | 1-45 |
| Air cleaner filter | 6-9 |
| Antitheft system | 1-48 ~ 1-50 |
| Ashtray | 1-28, 1-29 |
| Audio system | 1-51 ~ 1-62 |
| Automatic transaxle | |
| - Checking fluid | 6-11 |
| - operation | 2-6 |
| - overdrive switch | 2-9 |
| - normal/economy switch | 2-8 |

B

| | |
|--------------------------------------|-------------|
| Balancing tires | 8-4 |
| Battery | 6-18 |
| Bi-level heating | 1-43 |
| Brake | |
| - fluid | 6-12 ~ 6-13 |
| - operation | 2-9 |
| - pedal play | 6-16 |
| - pedal clearance | 6-16 |
| "Breaking In" your new Hyundai | 1-2 |

C

| | |
|------------------------------|-------------|
| Child protector locks | 1-4 |
| Child restraint system | 1-12 ~ 1-14 |
| Cigarette lighter | 1-28 |
| Cleaning | |
| - interior | 4-4 |
| - exterior | 4-2 ~ 4-4 |

| | |
|----------------------------|-----------|
| Clock | 1-27 |
| Consumer information | 8-1 ~ 8-6 |
| Coolant | |
| - changing | 6-7 ~ 6-8 |
| Cooling system | |
| - checking | 6-7 |
| - fans | 6-19 |
| Corrosion protection | 4-2 |

D

| | |
|----------------------------------|------------|
| Day-night mirror | 1-33 |
| Defroster | |
| - rear window | 1-27 |
| - lever type | 1-40 |
| - rotary type | 1-44 |
| Do-It-Yourself maintenance | 6-1 |
| Door locks | 1-3 ~ 1-4 |
| Drink holder | 1-29 |
| Drive belts | 6-14 |
| Driving tips | 2-3 ~ 2-13 |

E

| | |
|-------------------------------|-----------|
| Economical driving | 2-10 |
| Electric cooling fans | 6-19 |
| Emission control system | 7-1 ~ 7-3 |
| Emergency | |
| - flat tire | 3-5 ~ 3-8 |
| - starting | 3-2 |
| - towing | 3-10 |
| Engine | |
| - compartment | 6-2 ~ 6-3 |
| - number | 8-2 |

INDEX

- oil6-5
- starting2-4

- F**
- Fan
 - cooling6-19
 - heater (rotary type)1-38
 - heater (lever type)1-40
- Flat tire3-5
- Front fog light switch1-27
- Front seats1-5 ~ 1-6
- Fuel
 - filler door release1-36
 - requirements1-2
- Fuses6-17 ~ 6-18

- G**
- Gasohol1-2
- Gasoline (see fuel)1-2
- Gauges1-23
- Glove box1-32

- H**
- Hazard warning system1-26
- Headlight6-20
- Headrests1-5
- Heating system
 - rotary type1-38
 - lever type1-40
- High mounted stop light1-36
- Hood1-37
- Horn1-38

- I**
- Identification numbers8-2
- Idle speed9-3
- Ignition switch/steering lock2-3
- Inflation pressure, tire8-2
- Instrument cluster1-20
- Instruments and controls1-19
- Interior, cleaning4-4
- Interior light1-31, 1-32
- Intermittent wiper1-26

- J**
- Jacking, operation3-5
- Jump starting procedures3-2 ~ 3-3

- K**
- Keys1-3

- L**
- Lightbulb replacement6-20
- Light controls1-26
- Locks1-3 ~ 1-4
- Lost keys1-3, 3-10

- M**
- Maintenance
 - requirements5-2
 - Do-It-Yourself procedures6-1 ~ 6-21
 - schedules5-3 ~ 5-5
- Manuals, shop8-5
- Mirrors
 - day-night rear view1-33
 - outside rear view1-33

INDEX

- O**
Odometer 1-24
Oil engine
- adding 6-5
- filter 6-6
- changing 6-6
- checking 6-5
- overheating 3-3 ~ 3-4
- P**
Parking brake 1-34
Power steering fluid 6-19
Power windows 1-7
Pressure, tire (see glove box) 8-2
- R**
Radio/tape player 1-49 ~ 1-58
Rear seats 1-34
Rear view mirror 1-33
Rear window defroster 1-26
Rear window wiper and washer 1-27
Remote
- fuel filler lid release 1-36
- trunk release 1-35
Reporting safety defects 8-7
Rheostat 1-28
Rotating tires 8-4
Room light 1-31, 1-32
- S**
Scheduled maintenance 5-3 ~ 5-5
Seats
- front 1-5 ~ 1-6
- rear 1-6
Seat belts
- care 1-8
- operating 1-8 ~ 1-10
Service requirements 5-2
Shop manual 8-5
Snow chains 8-3
Snow tires 8-3
Spare tire 3-4
Spark plugs 6-8
Specifications 9-1 ~ 9-3
Speedometer 1-23
Starting procedures 2-4
Steering
- column lock 2-3
- tilt 1-38
Stereo sound system 1-46 ~ 1-48
Sunshade 1-29
Sunroof 1-30
Sun visor 1-37
- T**
Tachometer 1-24
Tires
- balancing 8-4
- chains 8-3
- flat 3-5
- information 8-2
- pressure (see glove box) 8-3
- replacement 8-4
- rotation 8-4
- snow tires 8-3
- traction 8-4

INDEX

| | |
|---|-------------|
| Towing | |
| - a trailer | 2-13 |
| - your car | 3-9 ~ 3-10 |
| Transaxle | |
| - automatic | 2-6 ~ 2-9 |
| - automatic transaxle fluid check | 6-11 |
| - manual transaxle fluid check | 6-10 ~ 6-11 |
| Trip odometer | 1-24 |
| Trunk | 1-35 |
| V | |
| Vehicle identification number | 8-2 |
| Ventilation | |
| - rotary type | 1-43 |
| - lever type | 1-40 |
| VIN | 8-2 |
| W | |
| Warning lights | 1-21 ~ 1-23 |
| Washing and waxing | 4-3 ~ 4-4 |
| Windows | 1-7 |
| Wiper blades | 6-10 |
| Wiper/washer fluid | 6-10 |

ZL000A1-A

This Owner's Manual should be considered a part of the car and remain with it when it is sold for the use of the next owner.

OWNER'S I.D.

ORIGINAL OWNER _____

ADDRESS _____

CITY _____ STATE _____ ZIP CODE _____

DELIVERY DATE _____

(Date Sold to Original Retail Purchaser)

DEALER NAME _____ DEALER NO. _____

ADDRESS _____

CITY _____ STATE _____ ZIP CODE _____

SERVICE STATION INFORMATION**FUEL:**

UNLEADED gasoline only
Pump Octane Rating of 87 (Research Octane Number 91)
or higher.

FUEL TANK CAPACITY

Original, US.gal (Imp.gal., liter) 11.9 (9.9,45)

TIRE PRESSURE:

See the label in the glove box.

OTHER TIRE INFORMATION:

See pages 8-2 through 8-6.

HOOD RELEASE:

Pull handle under left side of dash.

ENGINE OIL:

API grade SH, SG or SG/CD multigrade and fuel efficient oil.
Use SAE 10W-30 or 10W-40 if normal temperatures are
above -10°F (-23°C). For other viscosity recommenda-
tions, see page 6-5.

MANUAL TRANSAXLE:

API GL-4 or GL-5 SAE 75W/85W Oil level should be up to
filler-bolt hole in housing beside differential.

AUTOMATIC TRANSAXLE:

Apply the parking brake, with the engine running, shift the
selector lever through all ranges and return to "N" (Neutral)
position. Then check the level of fluid on the dipstick. Use
GENUINE HYUNDAI ATF AUTOMATIC TRANSAXLE
FLUID, MOPAR ATF PLUS TYPE 7176 or DIAMOND
ATF SP.

QUICK INDEX

| | |
|---|------|
| o Car will not start | 3-2 |
| o Flat tire | 3-5 |
| o Warning light/chime comes on | 1-21 |
| o Engine overheats | 3-3 |
| o Towing of your vehicle | 3-9 |
| o Starting the engine | 2-4 |
| o Driving tips for first 1,200 miles (2,000 km) | 1-2 |
| o Vehicle maintenance schedule | 5-3 |
| o Reporting safety defects | 8-7 |

HYUNDAI MOTOR COMPANY

Seoul Korea

Printing: SEP. 18, 1995

Publication No.: AO-950979

Printed in Korea